



HYDRAULIC PERFORMANCE TOLERANCE

Peerless Pump performance tests are determined acceptable based on the tolerances of the Hydraulic Institute, paragraph 1.6.5.3 Level "A", as follows (unless level "B" is customer specified).

At rated capacity;

Heads under 200 feet at 2999 US GPM and under = +8%, -0% Head

Heads under 200 feet at 3000 US GPM and over = +5%, -0% Head

Heads 201 feet to 500 feet, at any flow = +5%, -0% Head

Heads 501 feet and over, at any flow = +3%, -0 Head

OR

At rated head;

Capacity tolerance at rated head = +10%, -0% Capacity

The plus 8%, 5%, 3% head tolerances will result in a plus 8%, 5%, 3% pump horsepower requirement. Drivers must be selected allowing for the increased pump horsepower requirement.

Performance Guarantee

A guarantee of pump efficiency requires Peerless Pump factory engineering to determine and authorize a guarantee.

A Peerless Pump factory performance test is required for any performance guarantee.

A Peerless Pump factory authorized performance guarantees will be based on Peerless Pump factory testing.

A Peerless Pump factory determined and authorized efficiency guarantee will have a -0% tolerance.

A guarantee of pump performance is limited to one operating condition point only.

**HORIZONTAL SPLIT CASE PUMPS
SINGLE STAGE DOUBLE SUCTION
Type AE**

**Area Bound Curves*
1150 Nominal Rpm**

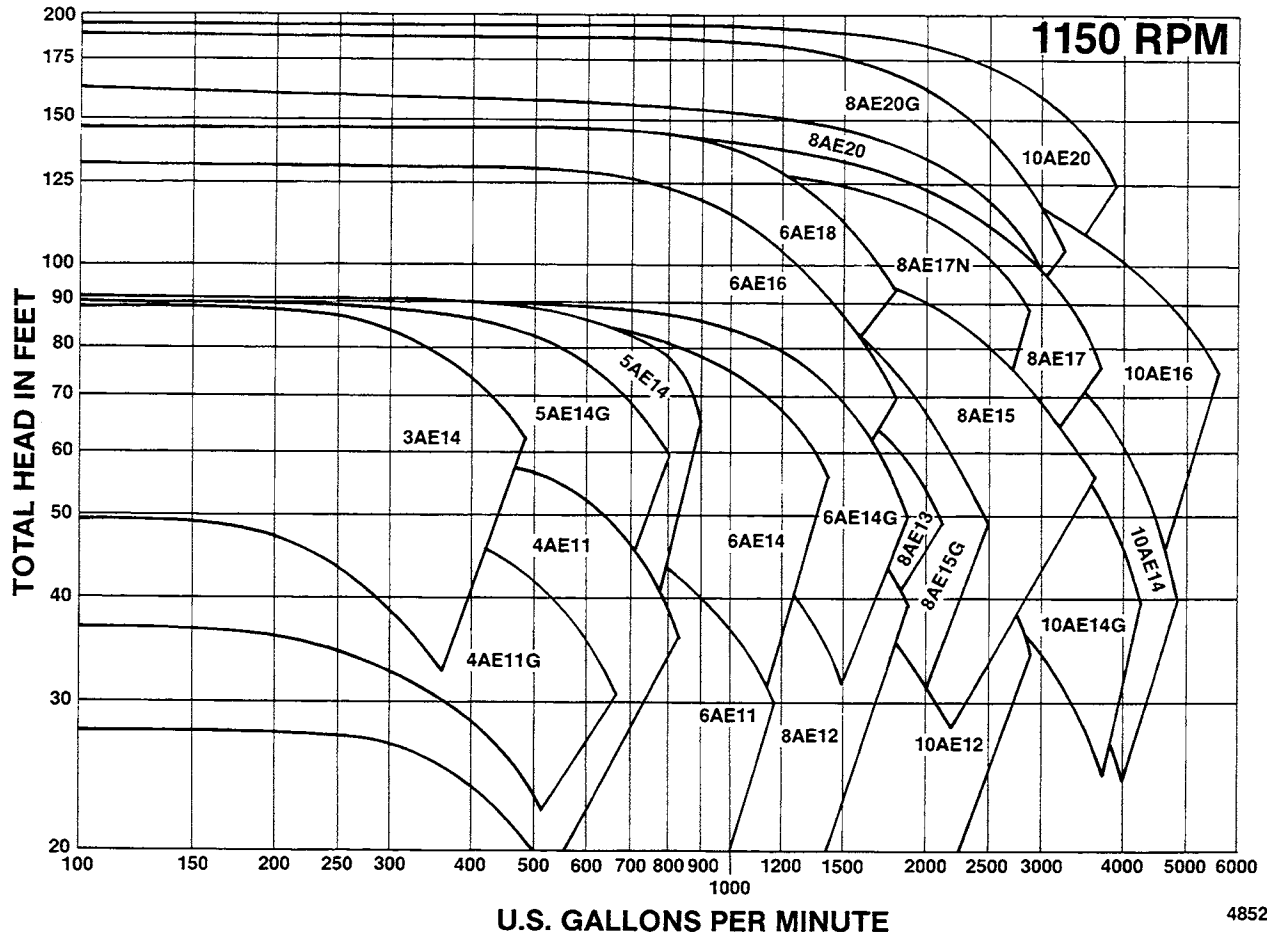

4852639

*Refer to the individual pump performance curves for specific conditions of service. Many pump models have several impeller selections which will influence the slope of the curve, carryout conditions and overall efficiency.

Subject to change without notice

HORIZONTAL SPLIT CASE PUMPS SINGLE STAGE DOUBLE SUCTION Type AE

**AREA BOUND CURVES*
1750 NOMINAL RPM**

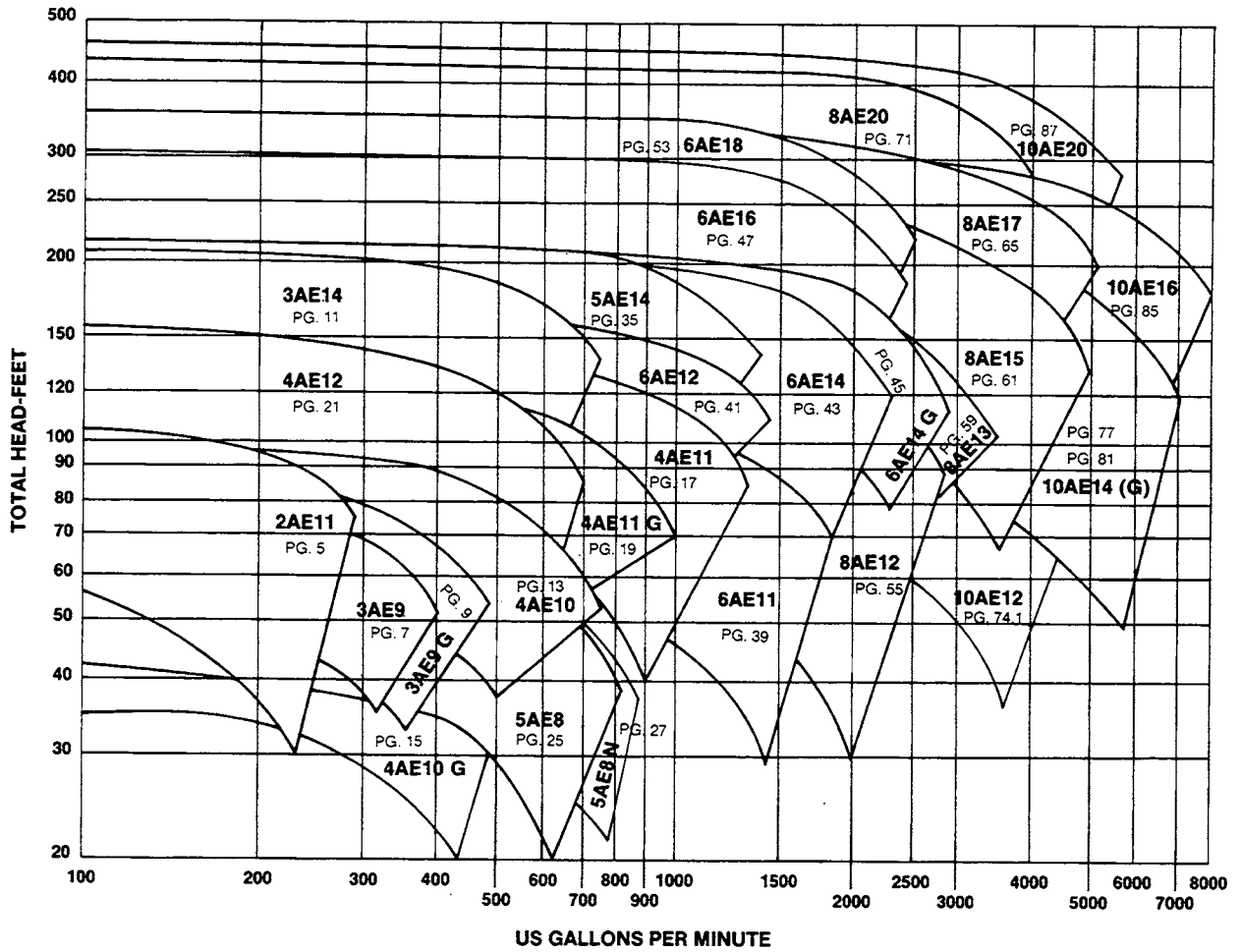

*Refer to individual pump performance curves for specific conditions of service. Many pump models have several impeller selections which will influence the slope of the curve, carry out conditions and overall efficiency.

HORIZONTAL SPLIT CASE PUMPS SINGLE STAGE DOUBLE SUCTION Type AE

AREA BOUND CURVES* 3550 NOMINAL RPM

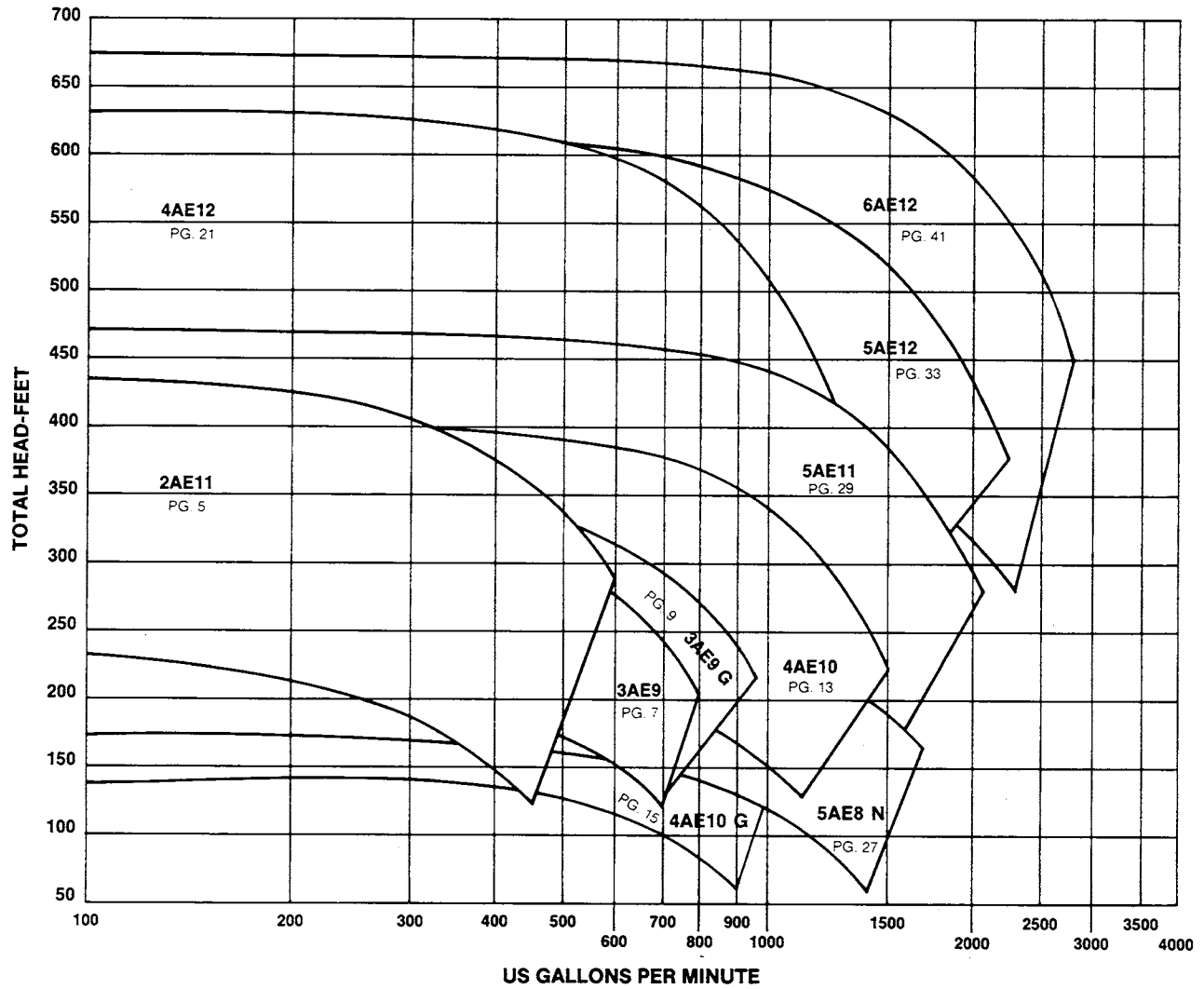

*Refer to individual pump performance curves for specific conditions of service. Many pump models have several impeller selections which will influence the slope of the curve, carry out conditions and overall efficiency.



**HORIZONTAL SPLIT CASE PUMPS
SINGLE STAGE DOUBLE SUCTION
Type AE**

**Area Bound Curves*
1450 Nominal Rpm**

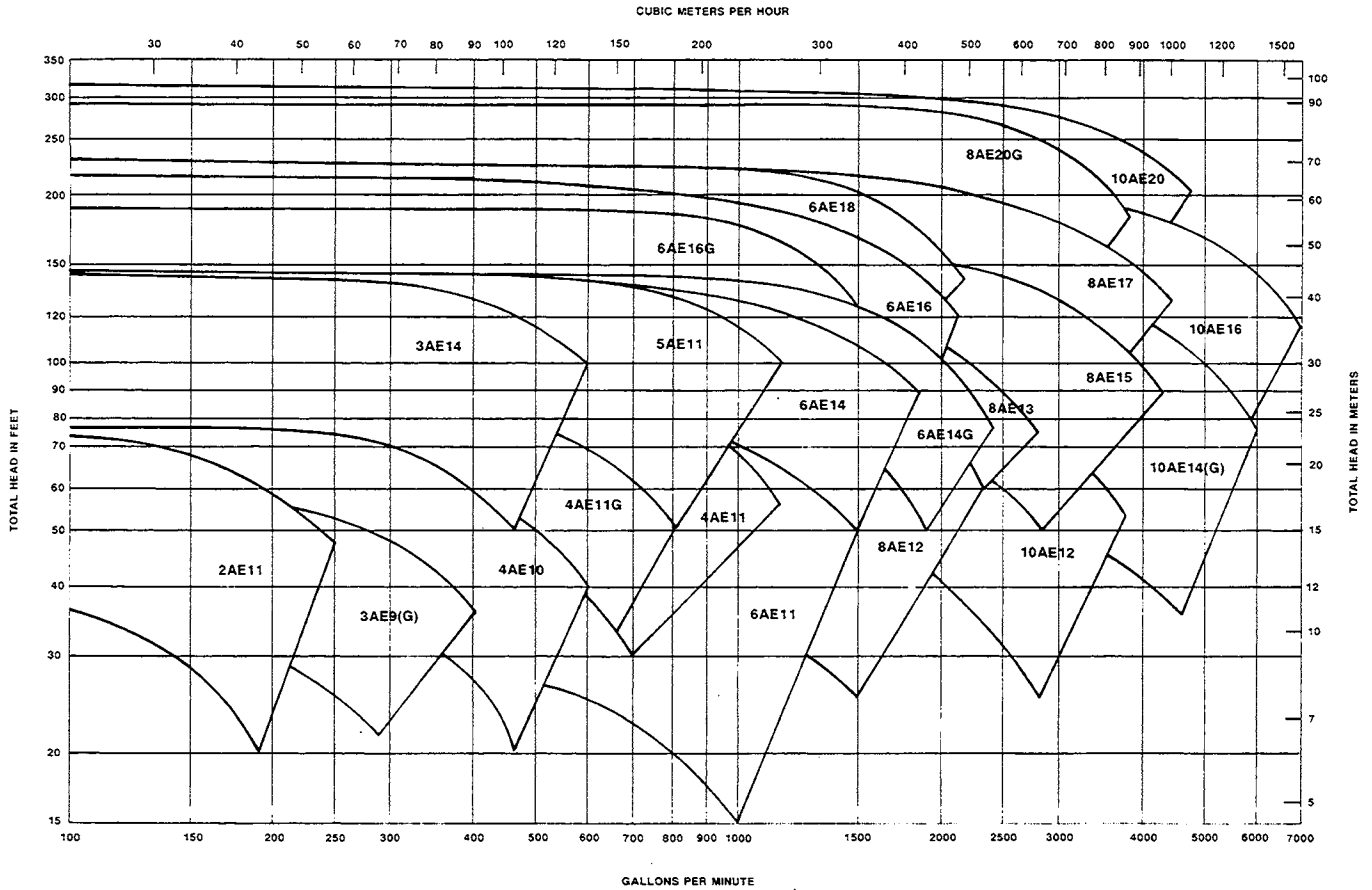

*Refer to the individual pump performance curves for specific conditions of service. Many pump models have several impeller selections which will influence the slope of the curve, carryout conditions and overall efficiency.

Subject to change without notice

HORIZONTAL SPLIT CASE PUMPS
SINGLE STAGE DOUBLE SUCTION
Type AE



Area Bound Curves*
2950 Nominal Rpm

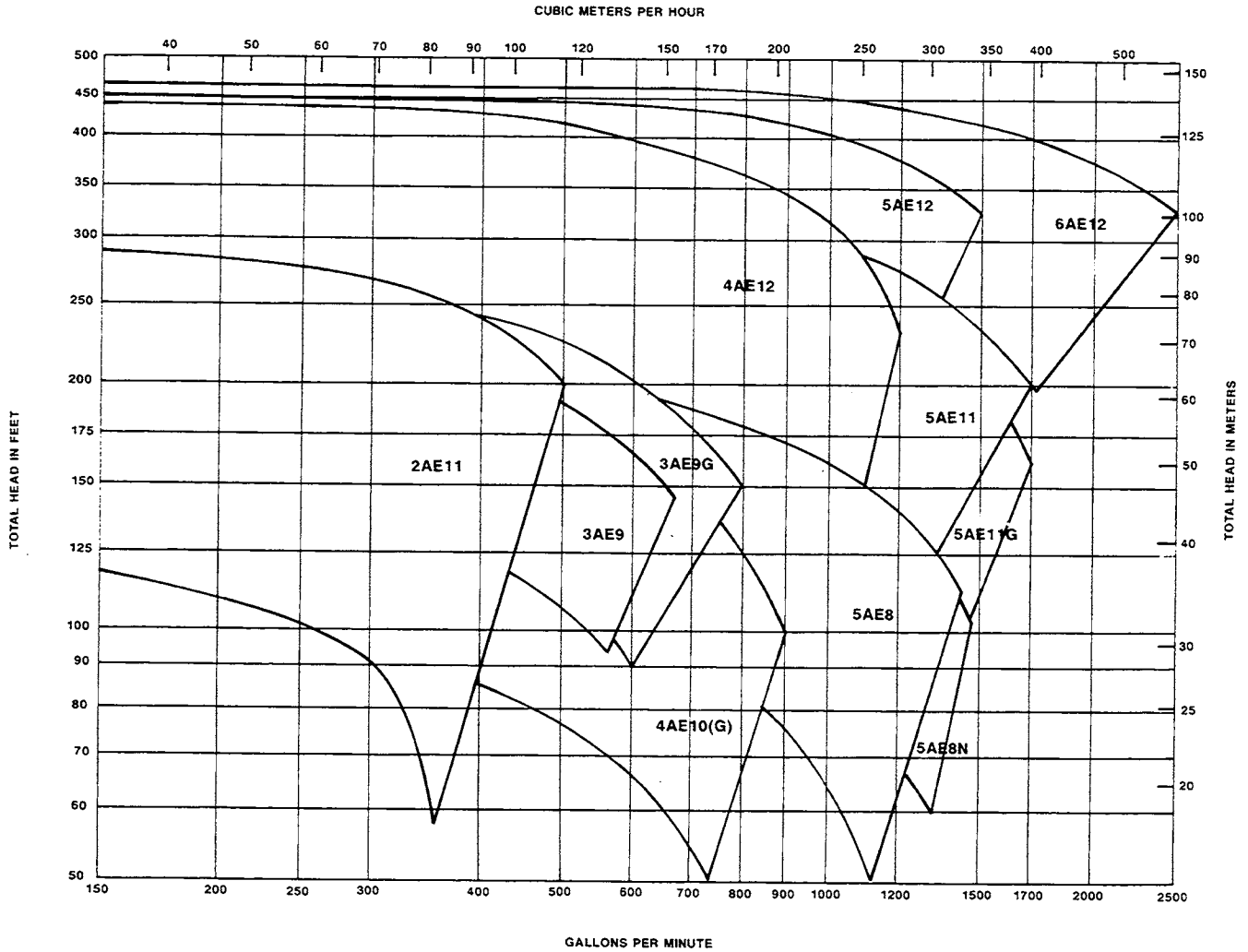

*Refer to the individual pump performance curves for specific conditions of service. Many pump models have several impeller selections which will influence the slope of the curve, carryout conditions and overall efficiency.

Subject to change without notice



Peerless Pump Company
Indianapolis, IN 46207-7026

HORIZONTAL SPLIT CASE PUMPS
Type 2AE11 Size 2 x 3 x 10.38

SECTION 1240

1150 RPM

VELOCITY HEAD INCLUDED
TOTAL EYE AREA 9.70 SQ. IN.
SPHERE SIZE .38 IN.
PERFORMANCE AT 1.0 SP. GR.

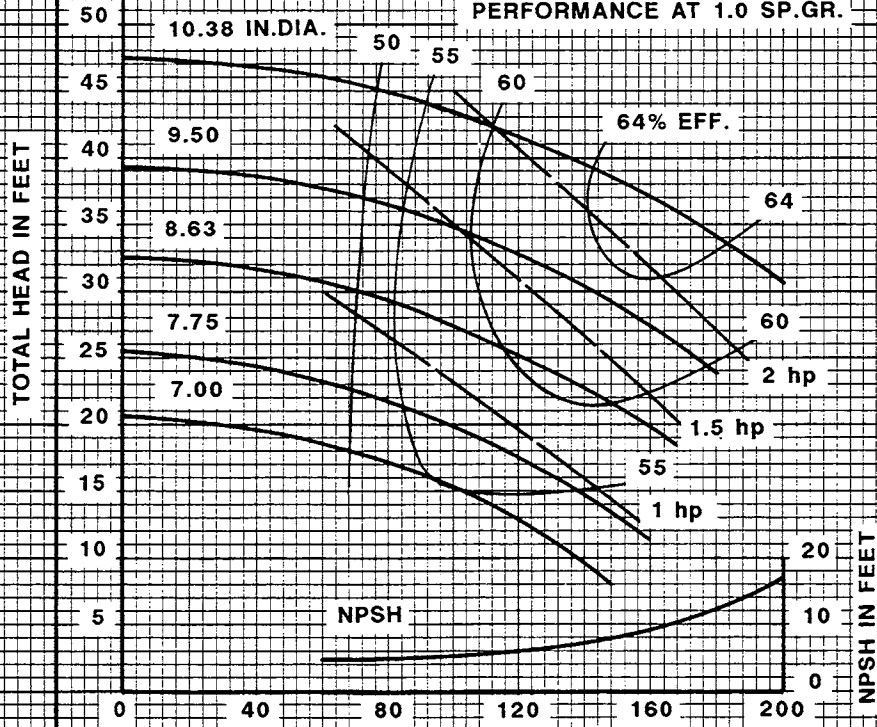

392

IMPELLER 2693522

U.S. GALLONS PER MINUTE

CURVE 3132128



Peerless Pump Company
Indianapolis, IN 46207-7026

HORIZONTAL SPLIT CASE PUMPS
Type 2AE11 Size 2x3x10.38

SECTION 1240

1750 RPM

VELOCITY HEAD INCLUDED
TOTAL EYE AREA 9.7 SQ. IN.
SPHERE SIZE .38 IN.
PERFORMANCE AT 1.0 SP. GR.

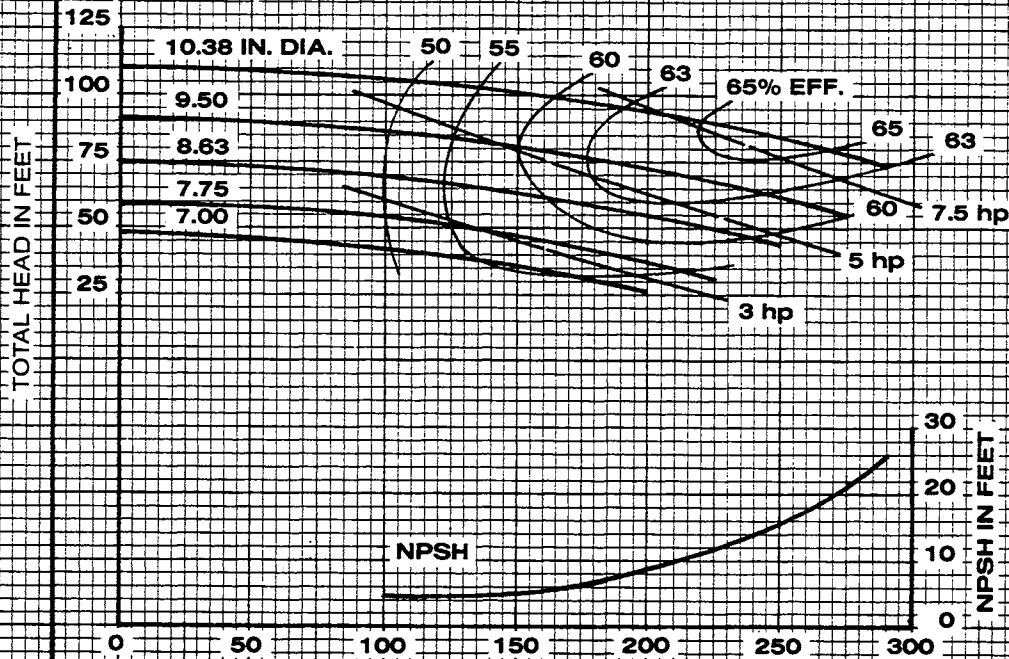

287

IMPELLER 2693522

U.S. GALLONS PER MINUTE

CURVE 3132042

3500 RPM

VELOCITY HEAD INCLUDED
TOTAL EYE AREA 9.7 SQ. IN.
SPHERE SIZE .38 IN.
PERFORMANCE AT 1.0 SP. GR.

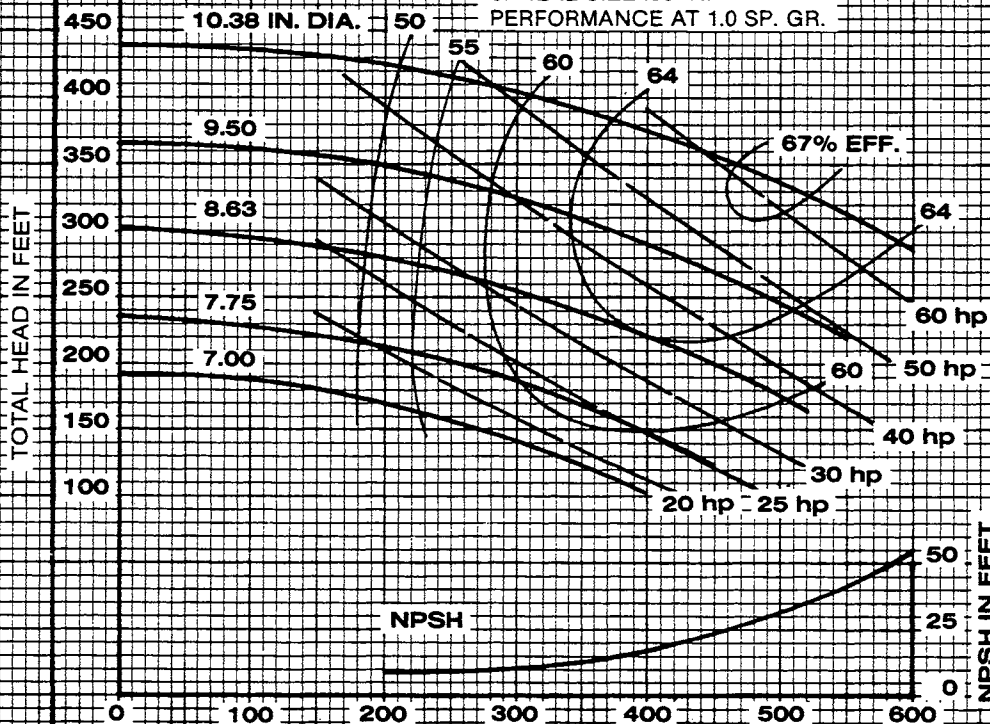

Rev. 787

IMPELLER 2693522

U.S. GALLONS PER MINUTE

CURVE 3132040



Peerless Pump Company
Indianapolis, IN 46207-7026

HORIZONTAL SPLIT CASE PUMPS
Type 3AE9 Size 3x4x9.00

SECTION 1240

1760 RPM

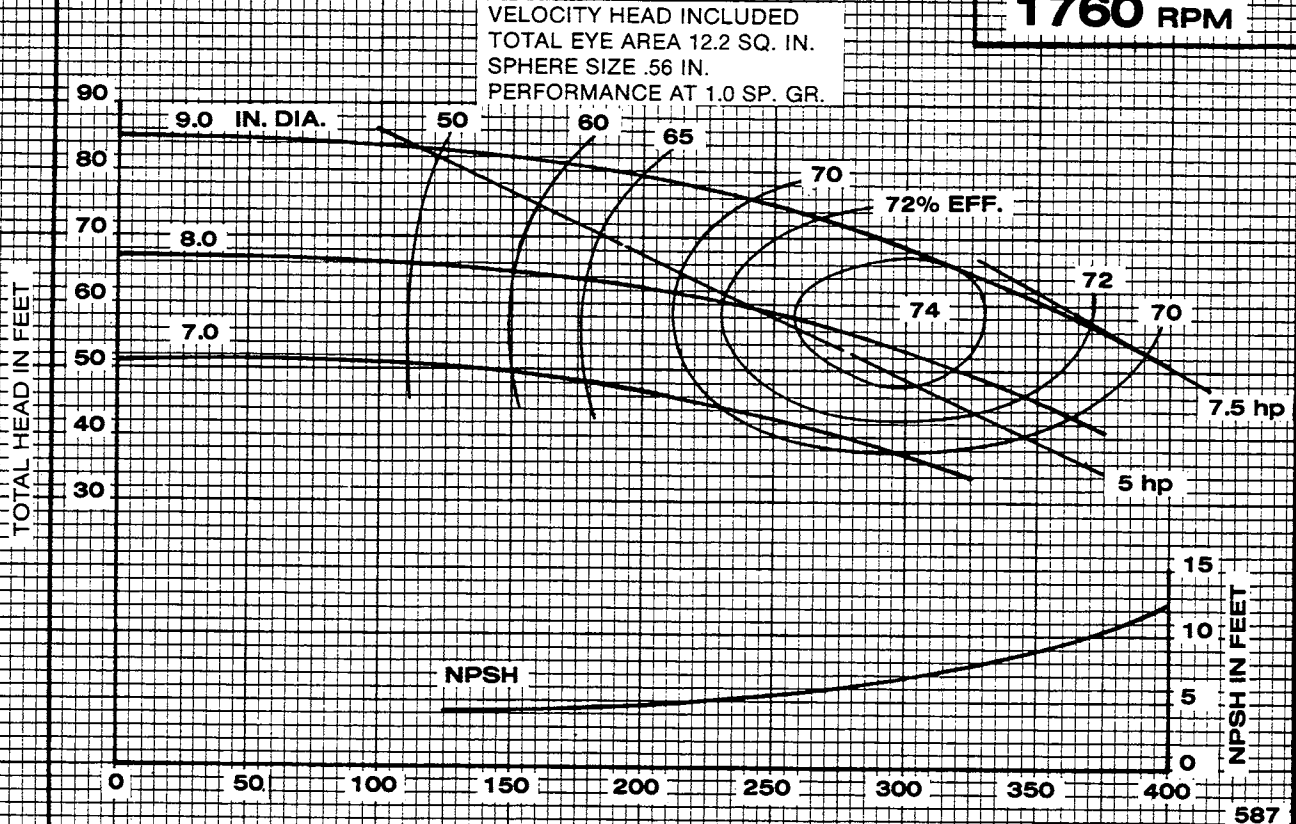

IMPELLER 2693450

U.S. GALLONS PER MINUTE

CURVE 3132065

3525 RPM

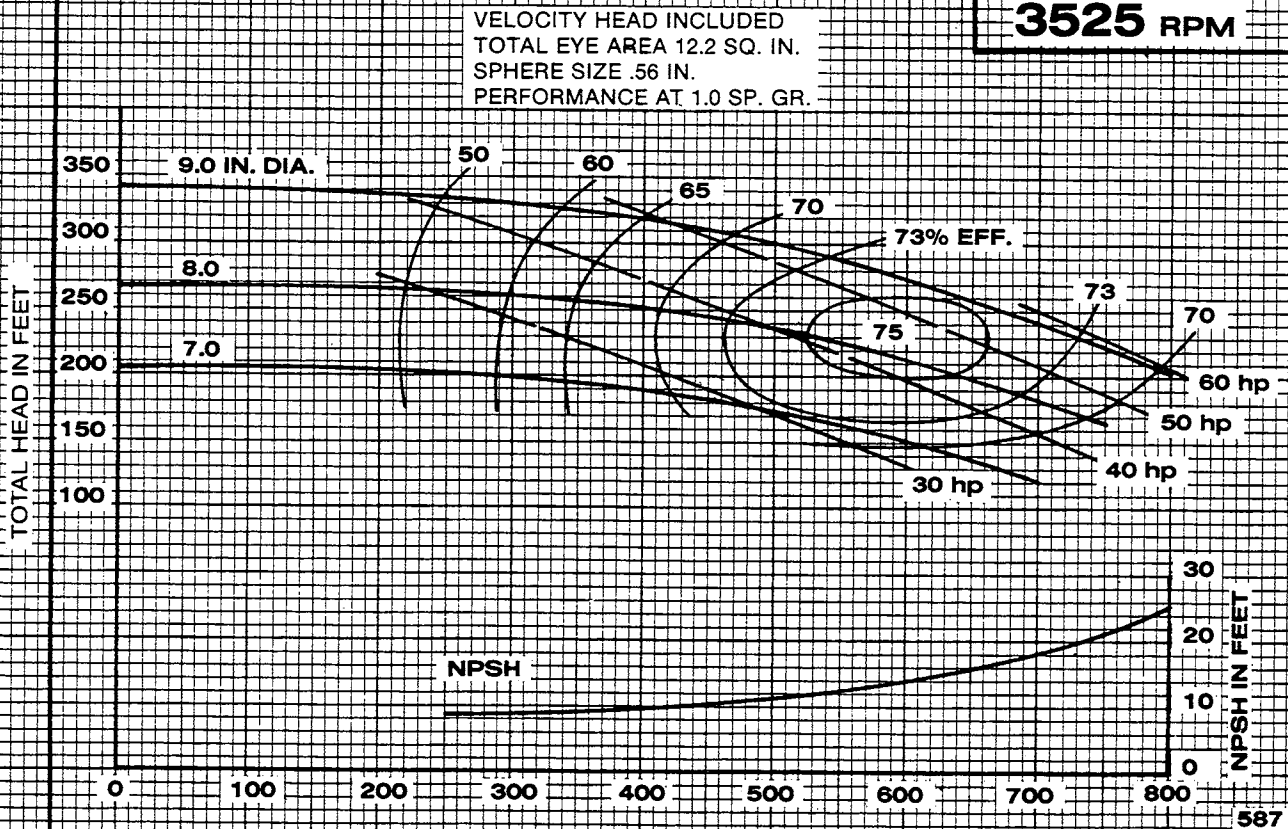

IMPELLER 2693450

U.S. GALLONS PER MINUTE

CURVE 3132063



Peerless Pump Company
Indianapolis, IN 46207-7026

HORIZONTAL SPLIT CASE PUMPS
Type 3AE9G Size 3 x 4 x 9.00

SECTION 1240

1150 RPM

VELOCITY HEAD INCLUDED
TOTAL EYE AREA 12.2 SQ.IN.
SPHERE SIZE .56 IN.
PERFORMANCE AT 1.0 SP.GR.

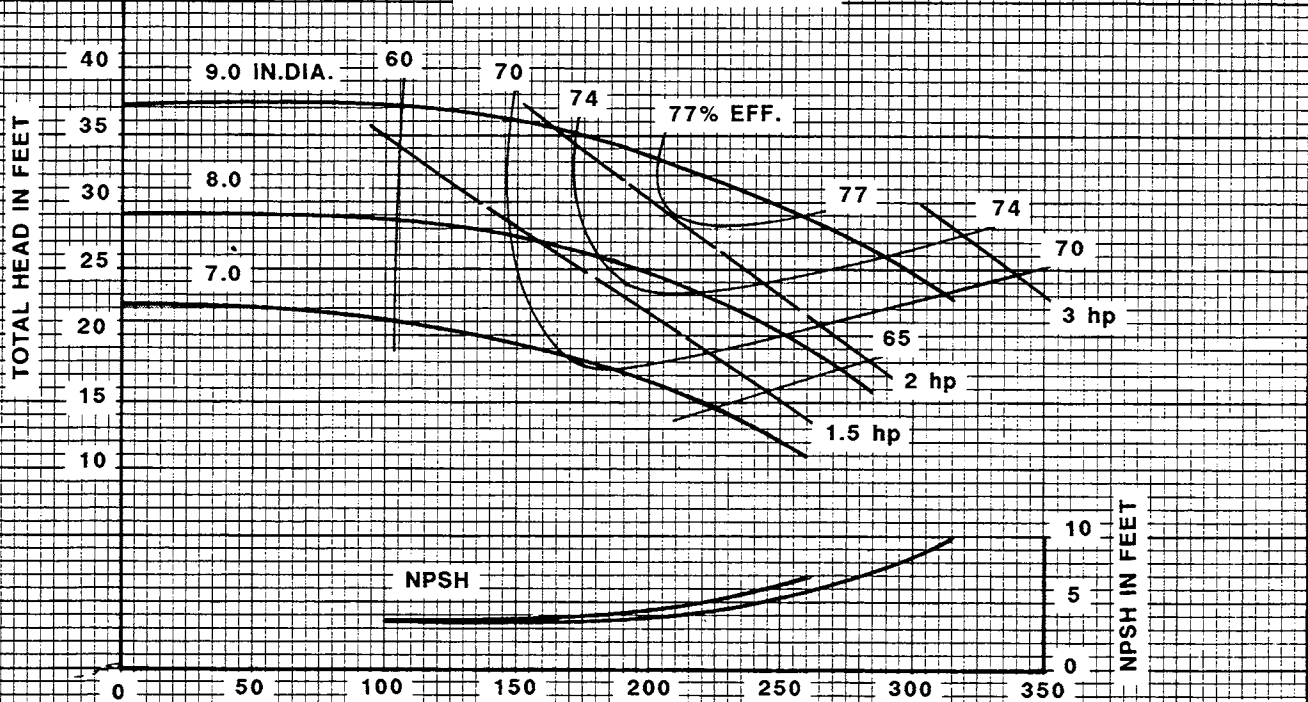

392

IMPELLER 2693451

U.S. GALLONS PER MINUTE

CURVE 3132129

1760 RPM

VELOCITY HEAD INCLUDED
TOTAL EYE AREA 12.2 SQ. IN.
SPHERE SIZE .56 IN.
PERFORMANCE AT 1.0 SP. GR.

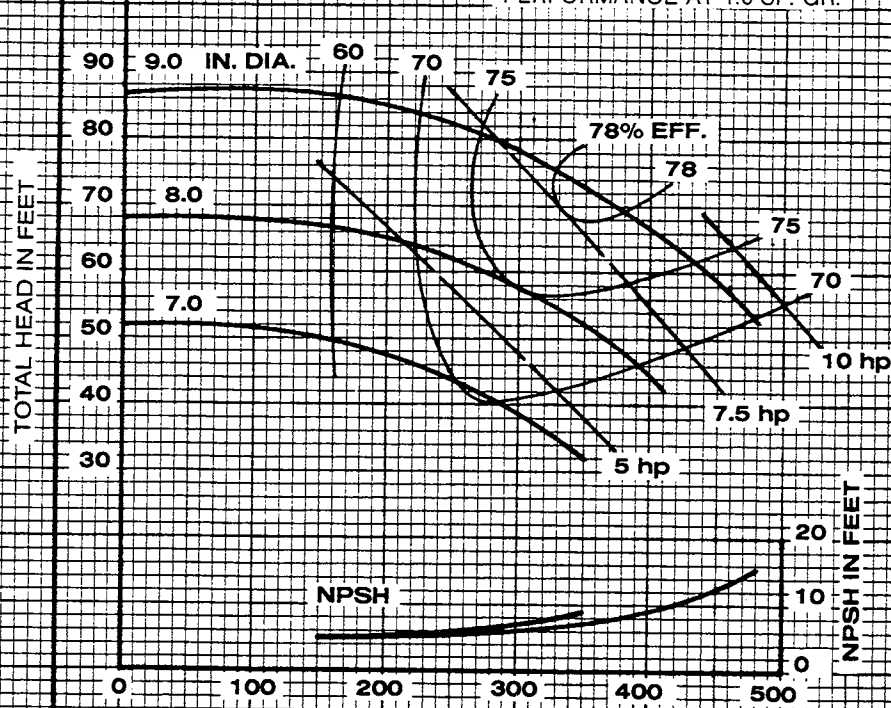

687

IMPELLER 2693451

U.S. GALLONS PER MINUTE

CURVE 3132062

3525 RPM

VELOCITY HEAD INCLUDED
TOTAL EYE AREA 12.2 SQ. IN.
SPHERE SIZE .56 IN.
PERFORMANCE AT 1.0 SP. GR.

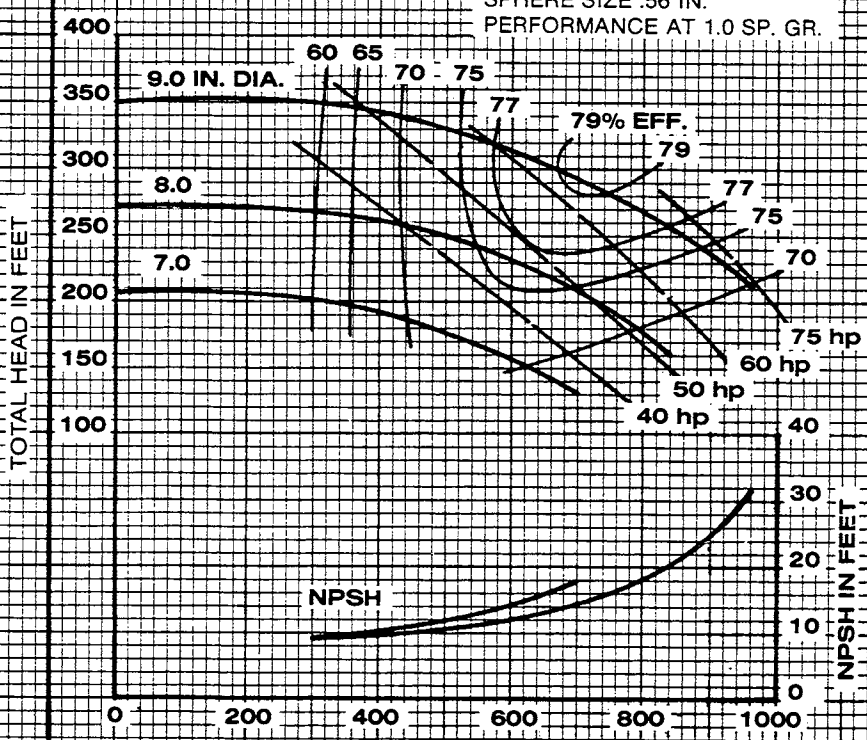

687

IMPELLER 2693451

U.S. GALLONS PER MINUTE

CURVE 3132060



Peerless Pump Company
Indianapolis, IN 46207-7026

HORIZONTAL SPLIT CASE PUMPS
Type 3AE14 Size 3x4x14.00

SECTION 1240

1150 RPM

VELOCITY HEAD INCLUDED
TOTAL EYE AREA 14.9 SQ. IN.
SPHERE SIZE .40 IN.
PERFORMANCE AT 1.0 SP. GR.

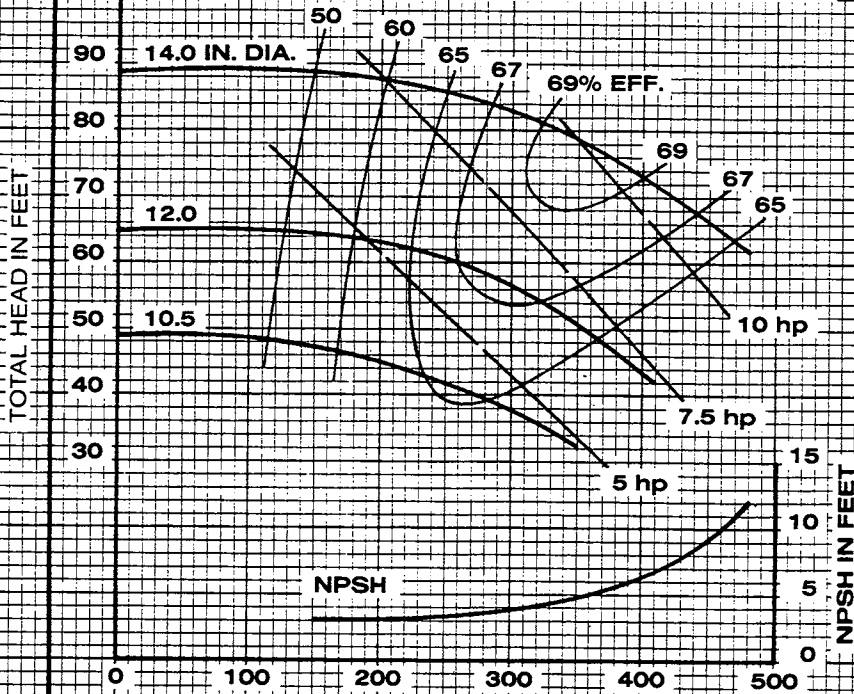

287

IMPELLER 2693509

U.S. GALLONS PER MINUTE

CURVE 3132049

1750 RPM

VELOCITY HEAD INCLUDED
TOTAL EYE AREA 14.9 SQ. IN.
SPHERE SIZE .40 IN.
PERFORMANCE AT 1.0 SP. GR.

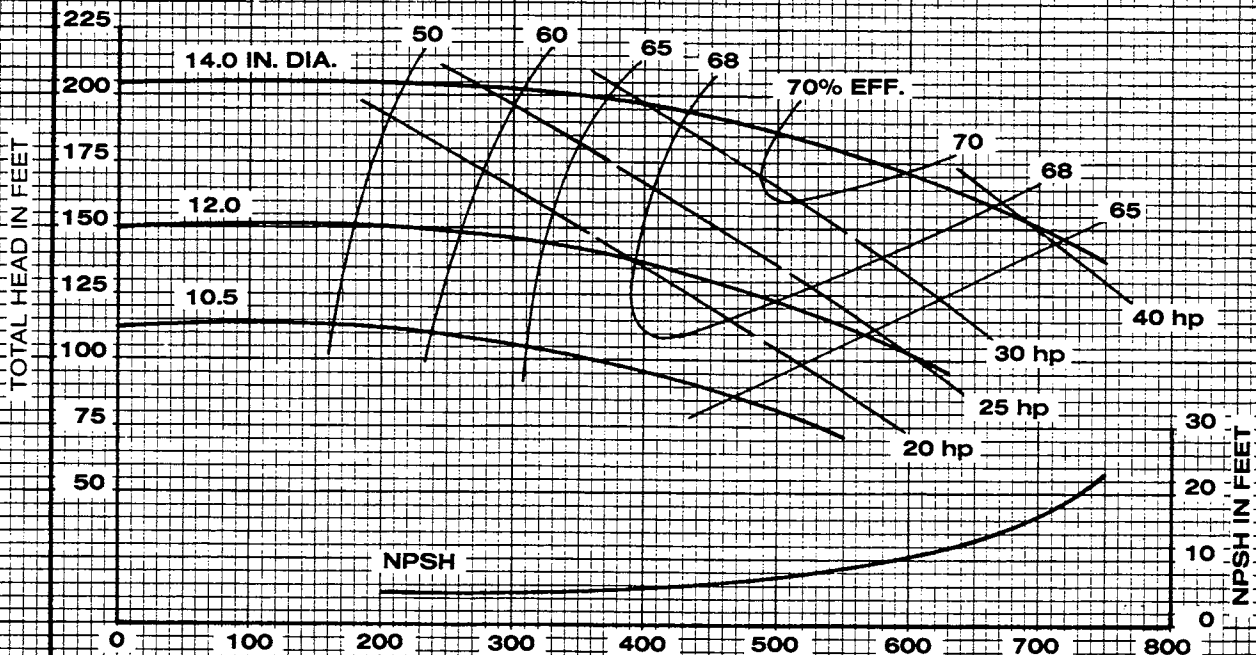

287

IMPELLER 2693509

U.S. GALLONS PER MINUTE

CURVE 3132047



Peerless Pump Company
Indianapolis, IN 46207-7026

HORIZONTAL SPLIT CASE PUMPS
Type 3AE14G Size 3 x 4 x 13

SECTION 1240

1150 RPM

VELOCITY HEAD INCLUDED
TOTAL EYE AREA 8.9 SQ.IN.
SPHERE SIZE .32 IN.
PERFORMANCE AT 1.0 SP.GR.

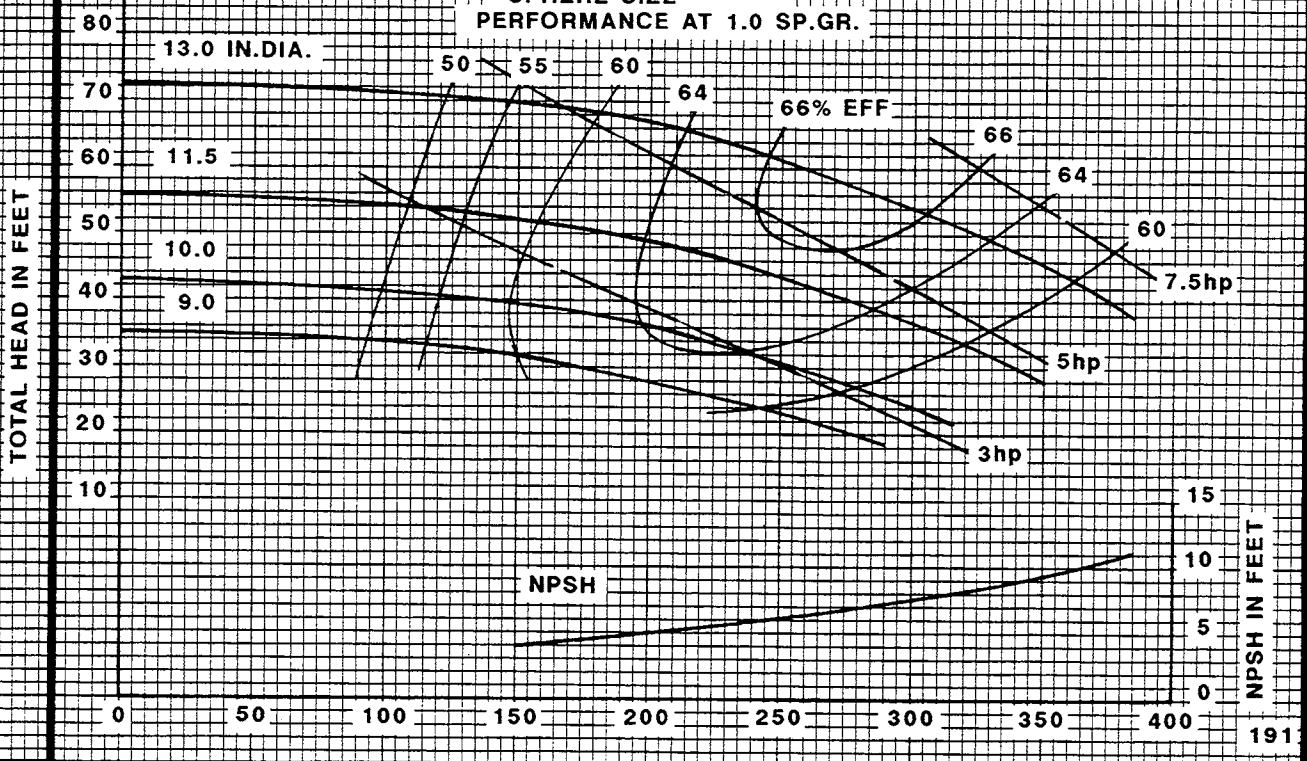

IMPELLER 2694939

U.S. GALLONS PER MINUTE

CURVE 3132123

1750 RPM

VELOCITY HEAD INCLUDED
TOTAL EYE AREA 8.9 SQ.IN.
SPHERE SIZE .32 IN.
PERFORMANCE AT 1.0 SP.GR.

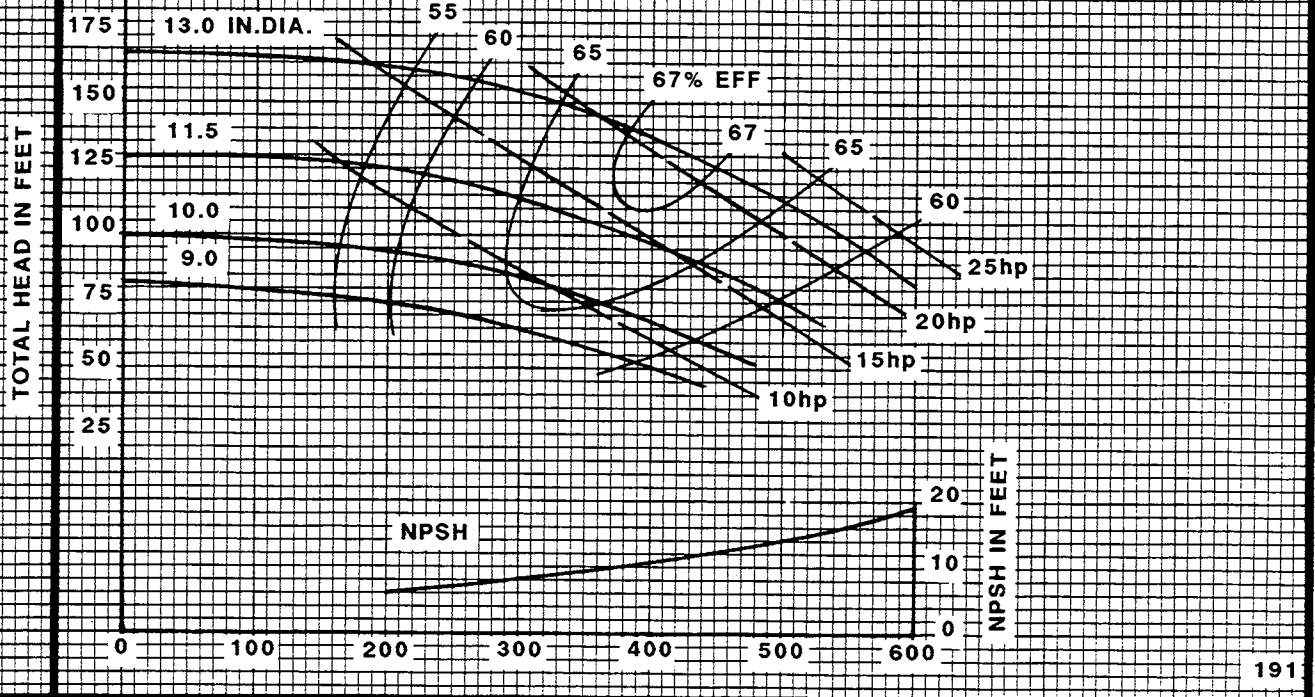

IMPELLER 2694939

U.S. GALLONS PER MINUTE

CURVE 3132121



Peerless Pump Company
Indianapolis, IN 46207-7026

HORIZONTAL SPLIT CASE PUMPS

Type 4AE10

Size 4 x 5 x 10.00

SECTION 1240

1150 RPM

VELOCITY HEAD INCLUDED
TOTAL EYE AREA 18.1 SQ.IN.
SPHERE SIZE .56 IN.
PERFORMANCE AT 1.0 SP.GR.

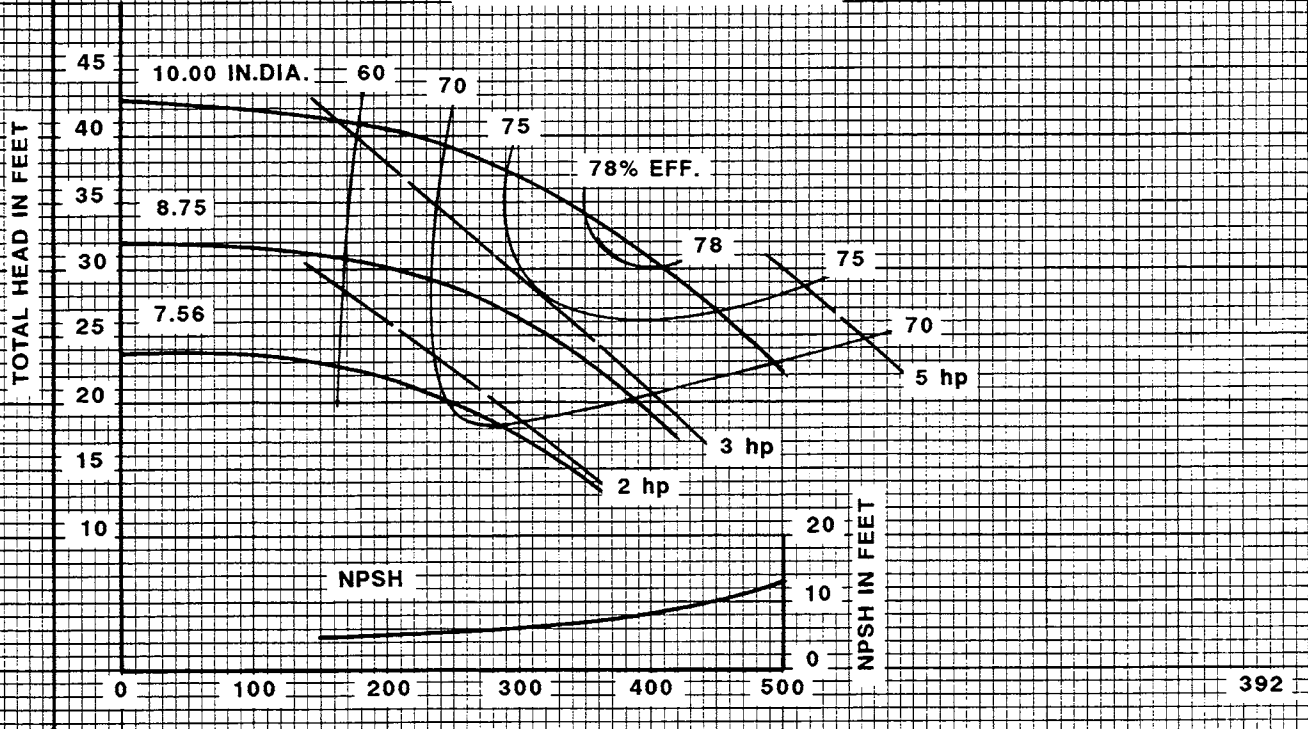

IMPELLER 2693319

U.S. GALLONS PER MINUTE

CURVE 3132130



Peerless Pump Company
Indianapolis, IN 46207-7026

HORIZONTAL SPLIT CASE PUMPS
Type 4AE10 Size 4x5x10.00

SECTION 1240

1750 RPM

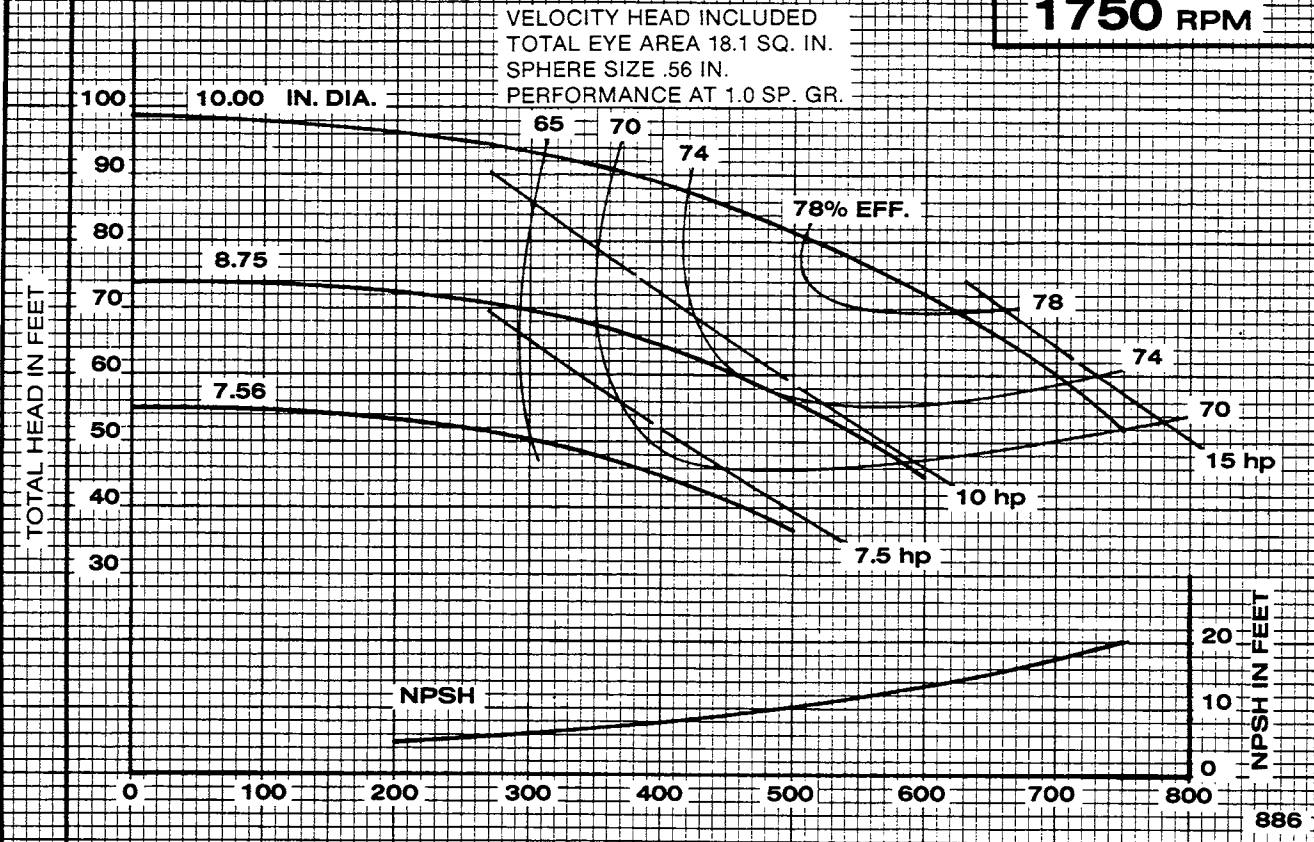

IMPELLER 2693319

U.S. GALLONS PER MINUTE

CURVE 3132012

3550 RPM

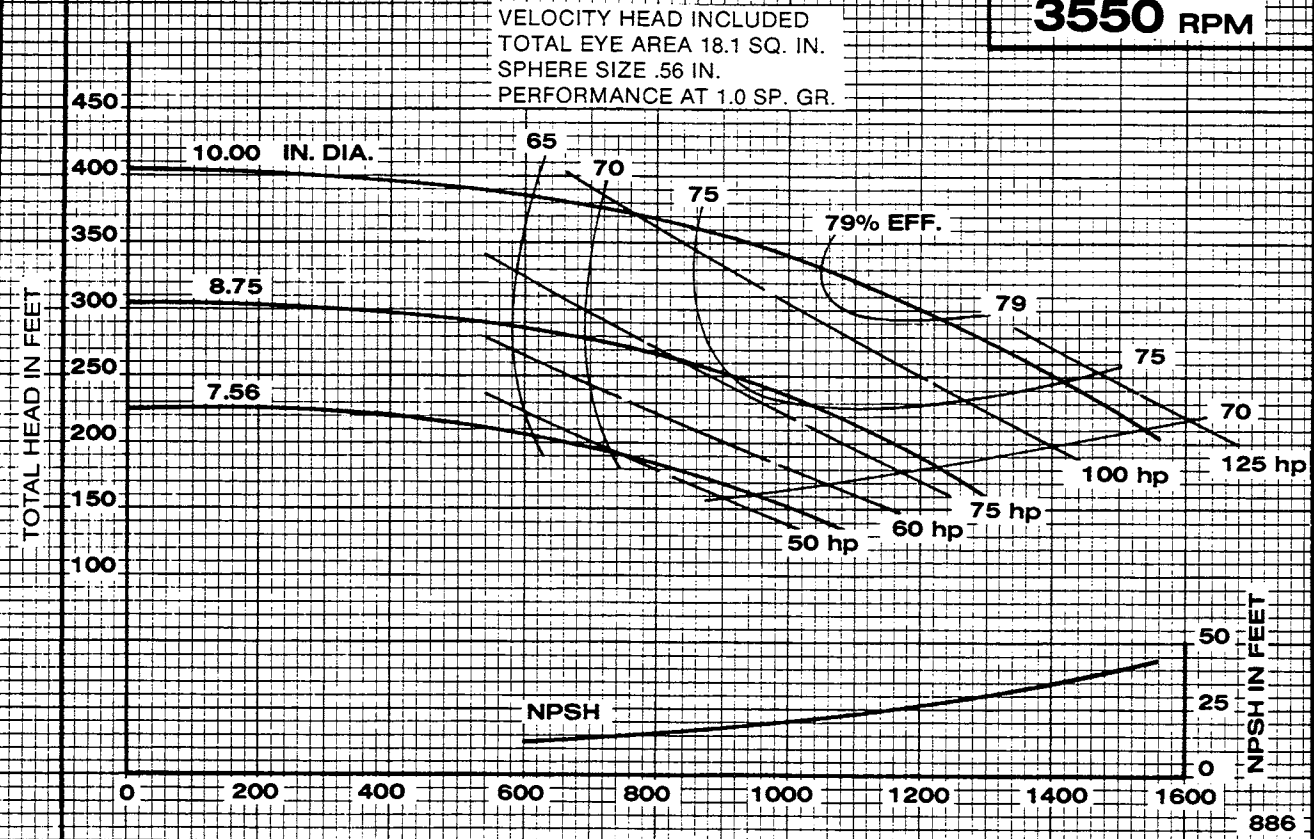

IMPELLER 2693319

U.S. GALLONS PER MINUTE

CURVE 3132010



Peerless Pump Company
Indianapolis, IN 46207-7026

HORIZONTAL SPLIT CASE PUMPS
Type 4AE10G Size 4 x 5 x 9.00

SECTION 1240

1760 RPM

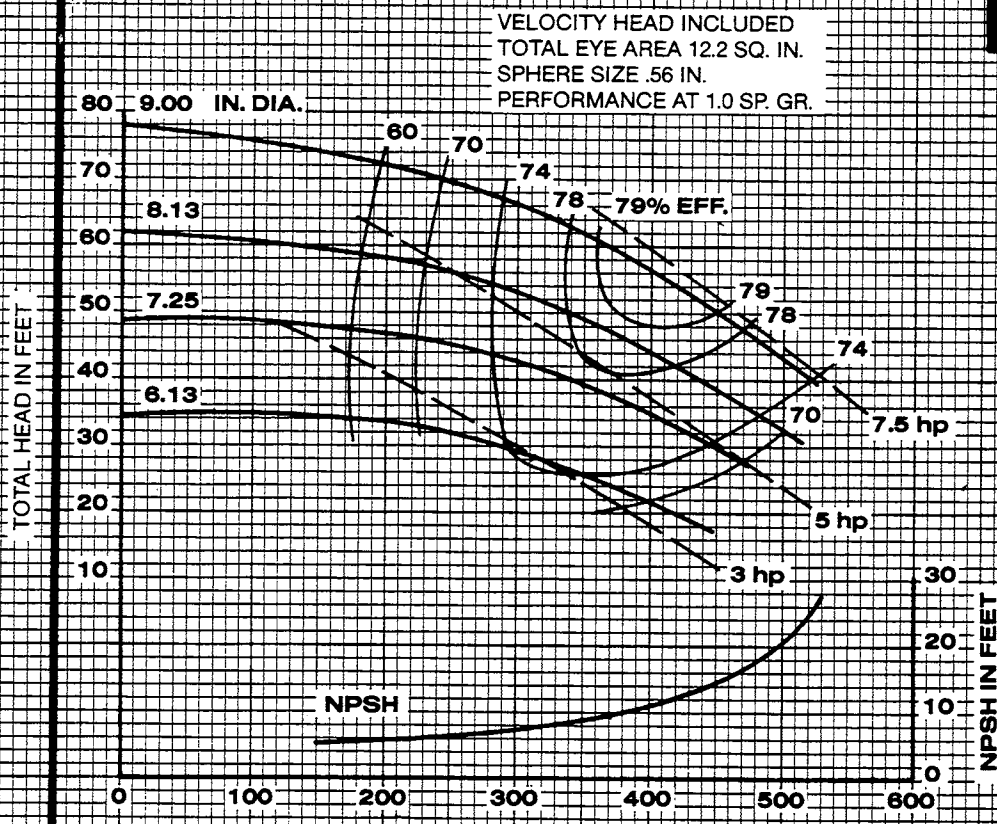

688

IMPELLER 2693450

U.S. GALLONS PER MINUTE

CURVE 3132092

3525 RPM

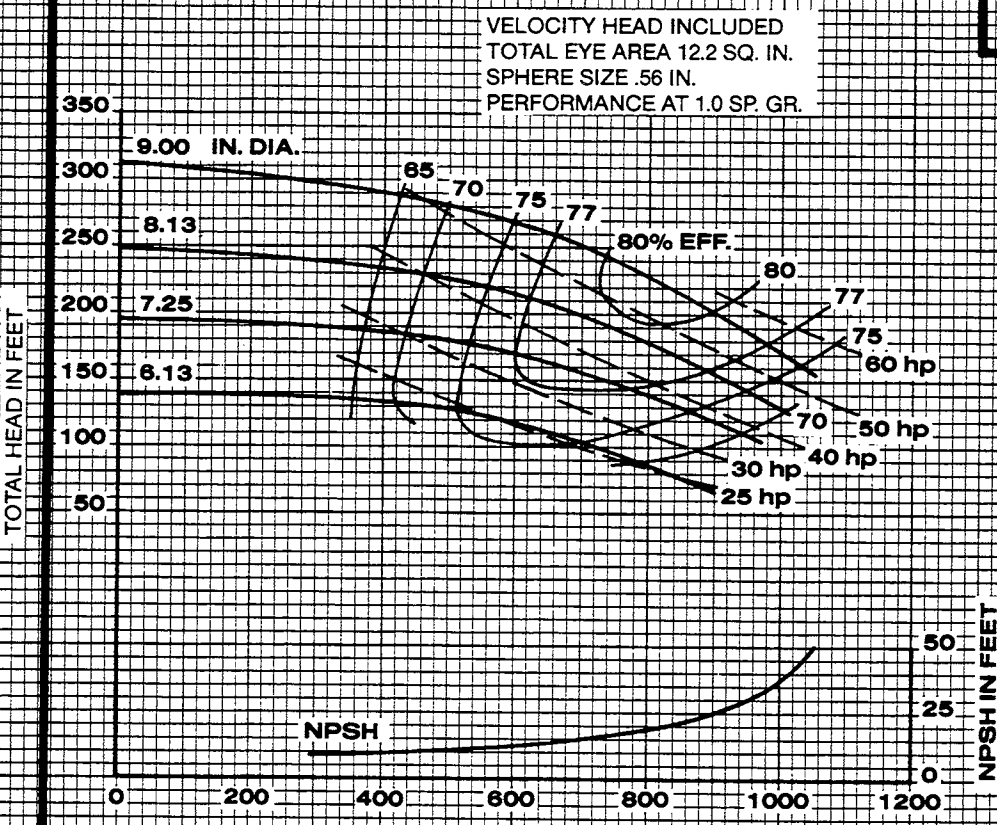

688

IMPELLER 2693450

U.S. GALLONS PER MINUTE

CURVE 3132090



Peerless Pump Company
Indianapolis, IN 46207-7026

HORIZONTAL SPLIT CASE PUMPS
Type 4AE11 Size 4x5x11.25

SECTION 1240

1150 RPM

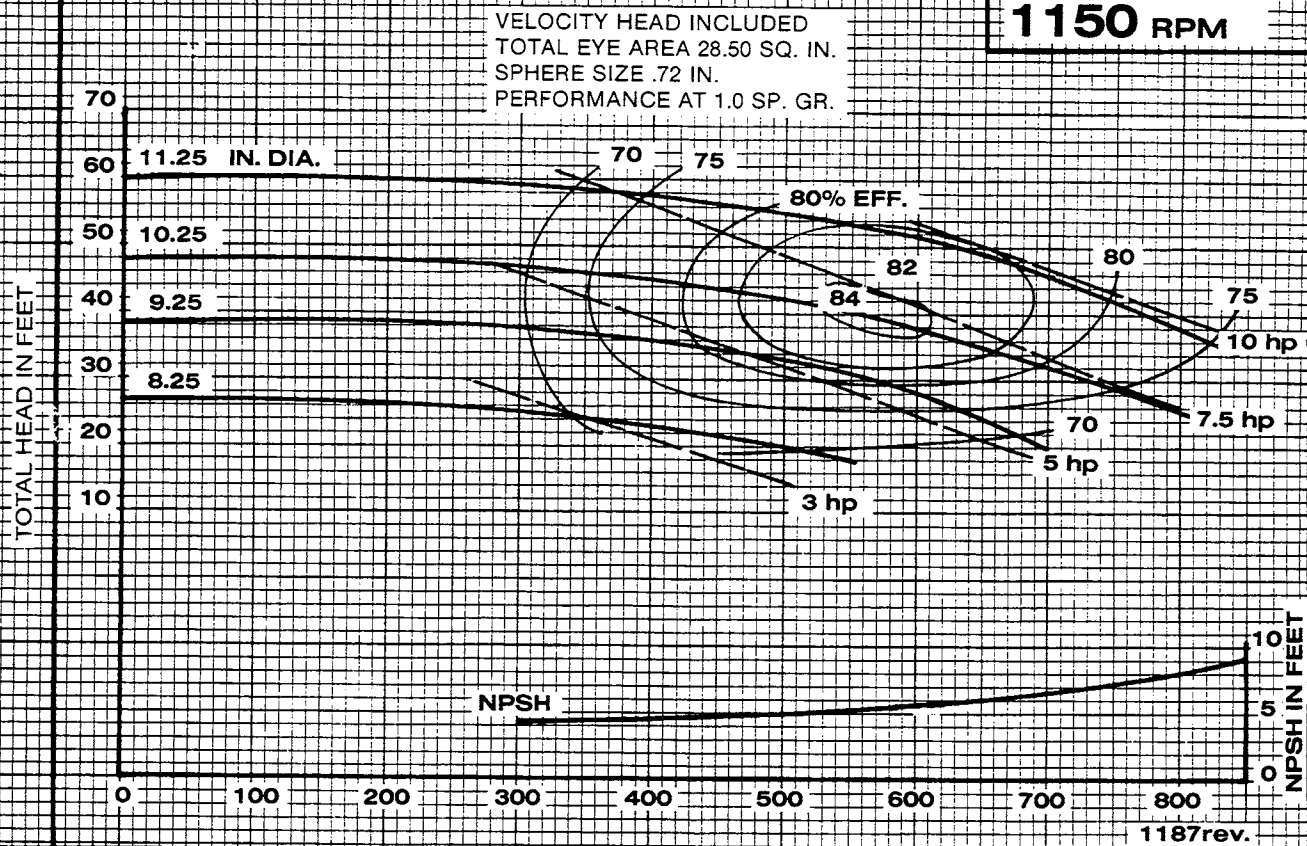

IMPELLER 2692930

U.S. GALLONS PER MINUTE

CURVE 3132005

1750 RPM

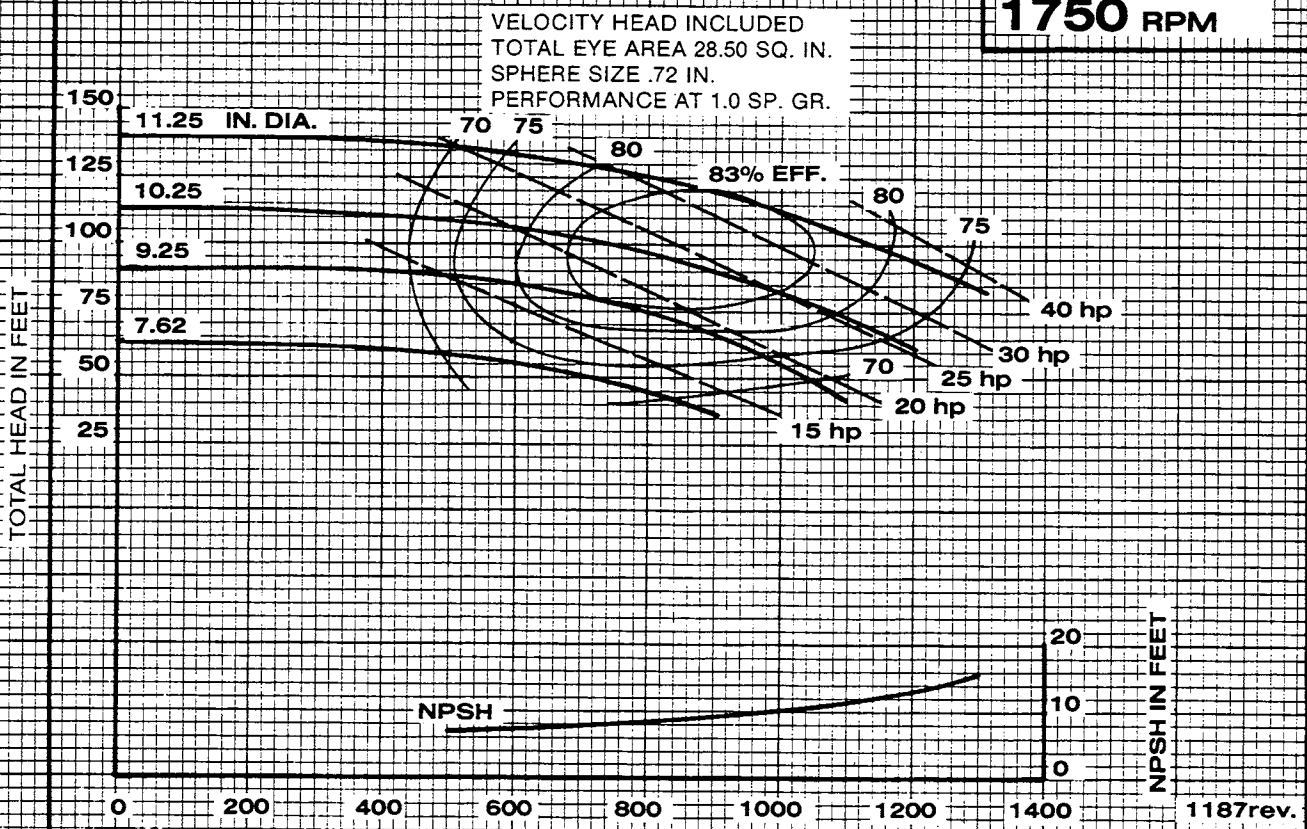

IMPELLER 2692930

U.S. GALLONS PER MINUTE

CURVE 3132003



Peerless Pump Company
Indianapolis, IN 46207-7025

HORIZONTAL SPLIT CASE PUMPS
Type 4AE11G Size 4x5x11.25

SECTION 1240

1150 RPM

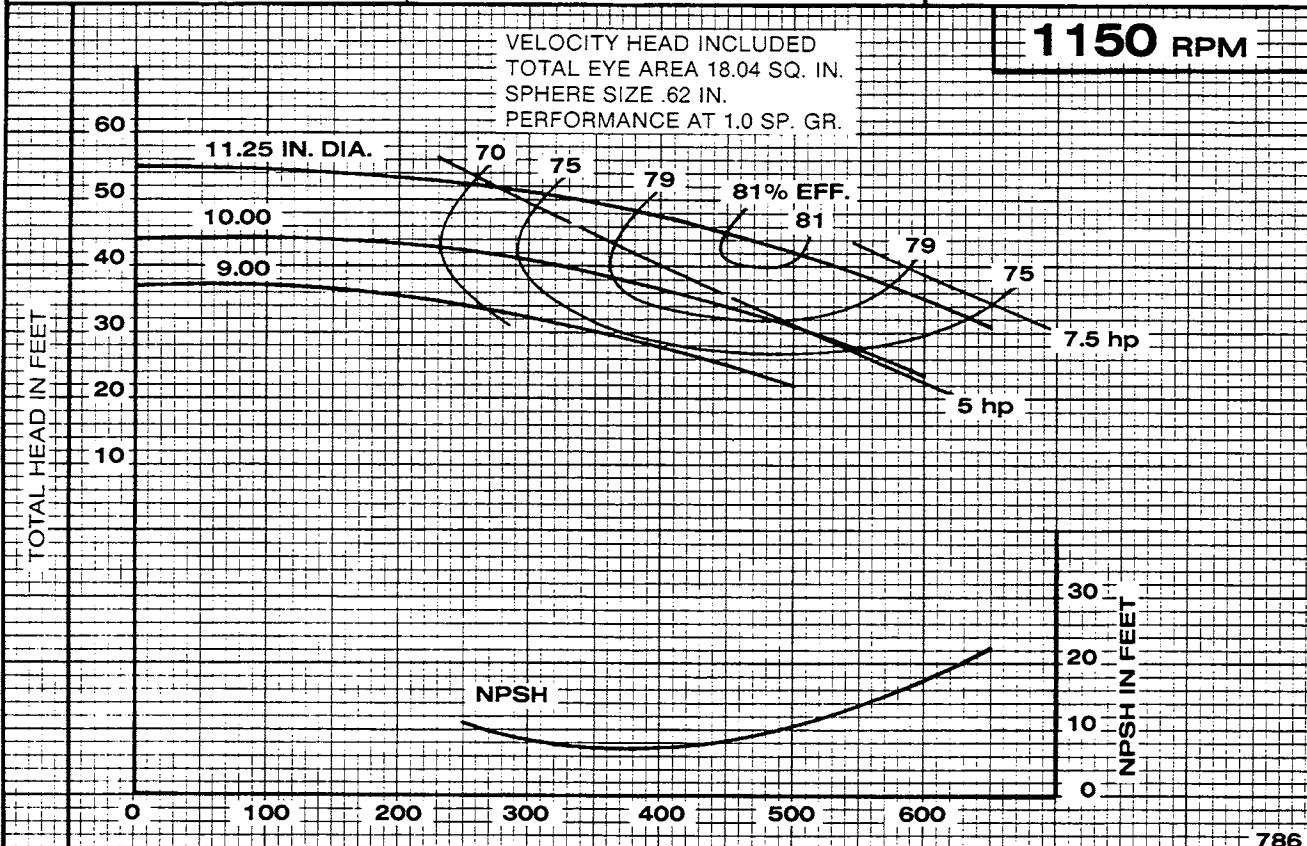

IMPELLER 2693667

U.S. GALLONS PER MINUTE

CURVE 3132015

1750 RPM

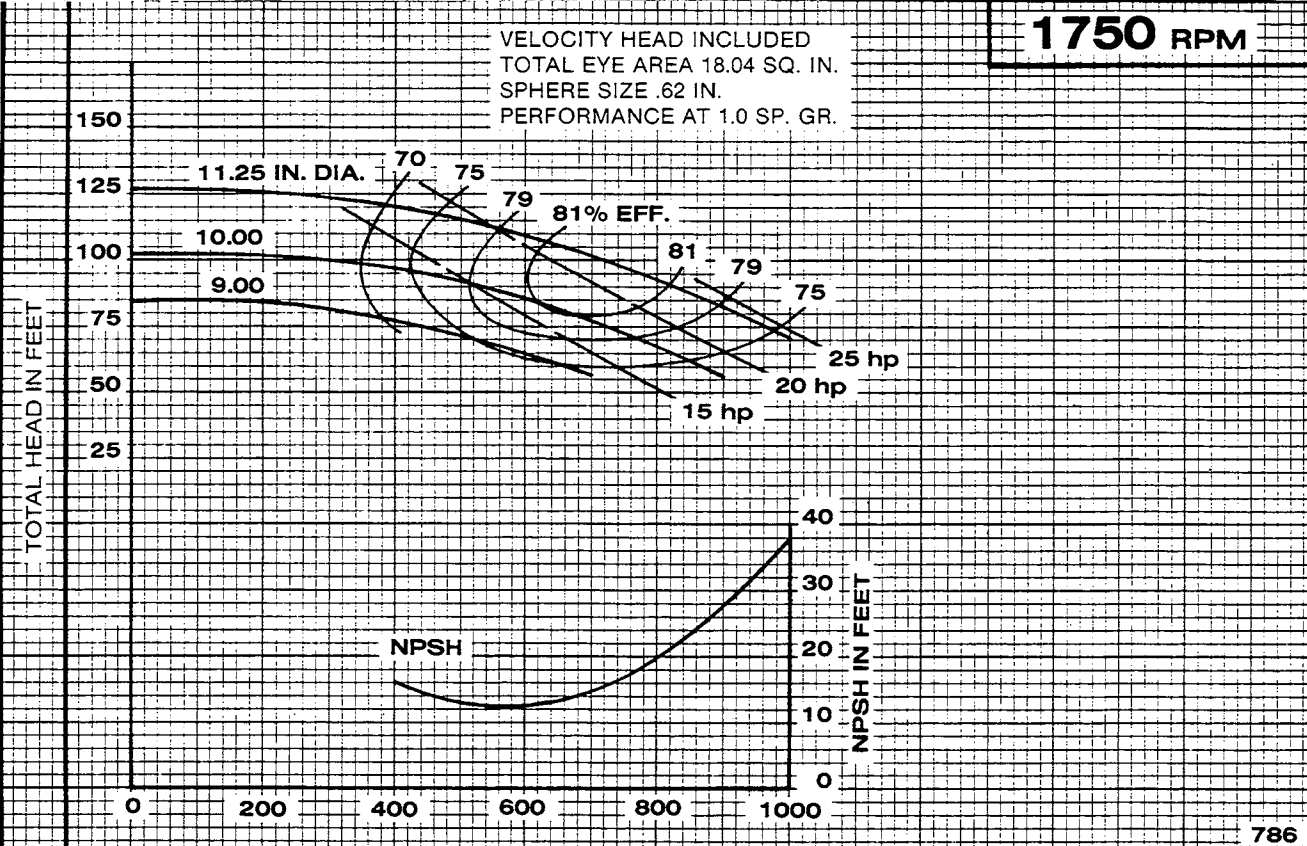

IMPELLER 2693667

U.S. GALLONS PER MINUTE

CURVE 3132013



Peerless Pump Company
Indianapolis, IN 46207-7026

HORIZONTAL SPLIT CASE PUMPS
Type 4AE12 Size 4x5x12.12

SECTION 1240

1750 RPM

VELOCITY HEAD INCLUDED
TOTAL EYE AREA 21.1 SQ. IN.
SPHERE SIZE .63 IN.
PERFORMANCE AT 1.0 SP. GR.

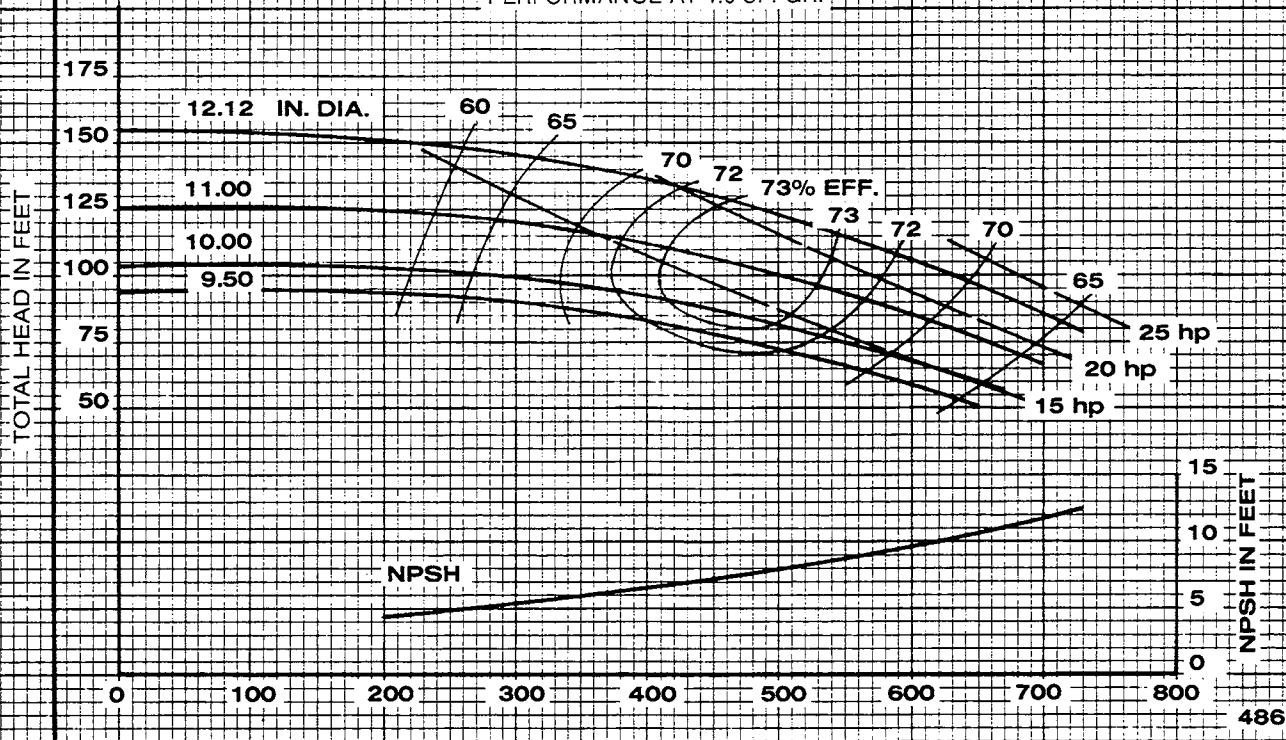

IMPELLER 2692300

U.S. GALLONS PER MINUTE

CURVE 3112002

3550 RPM

VELOCITY HEAD INCLUDED
TOTAL EYE AREA 21.1 SQ. IN.
SPHERE SIZE .63 IN.
PERFORMANCE AT 1.0 SP. GR.

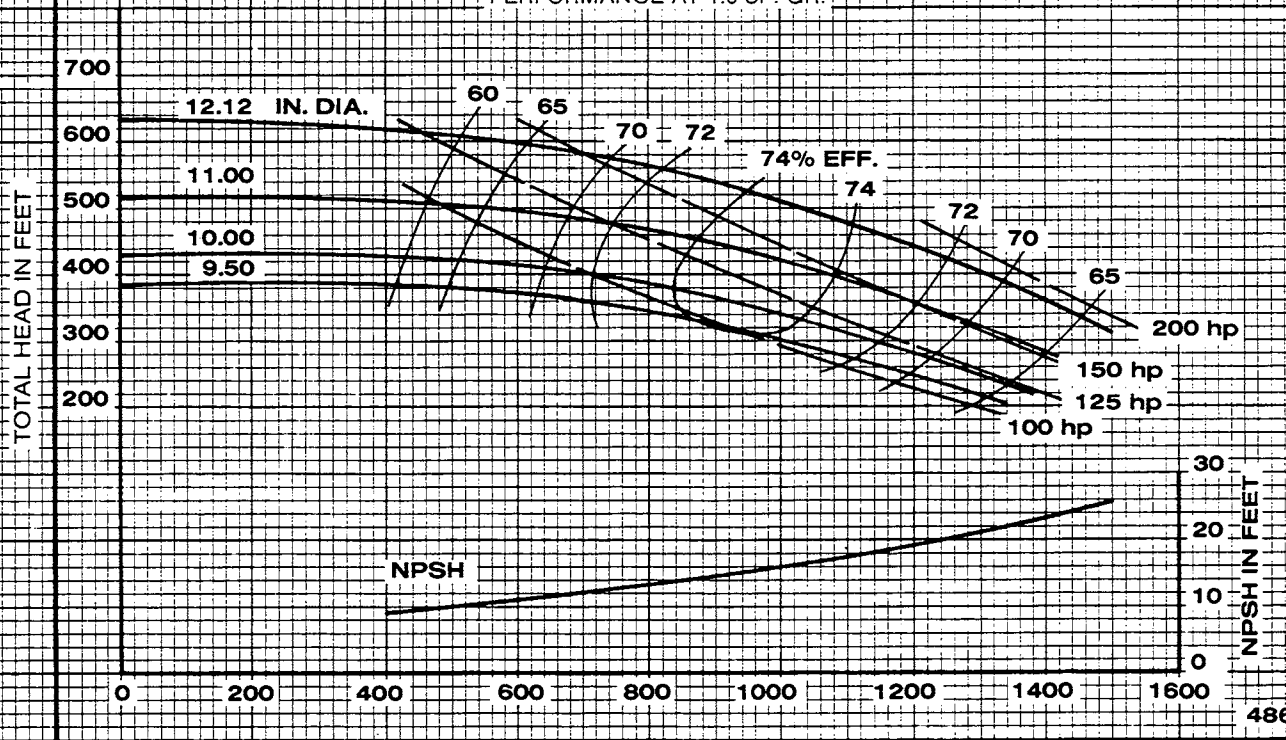

IMPELLER 2692300

U.S. GALLONS PER MINUTE

CURVE 3132000



Peerless Pump Company
Indianapolis, IN 46207-7026

HORIZONTAL SPLIT CASE PUMPS
Type 5AE8 Size 5x6x8.12

SECTION 1240

1750 RPM

VELOCITY HEAD INCLUDED
TOTAL EYE AREA 26.3 SQ. IN.
SPHERE SIZE .62 IN.
PERFORMANCE AT 1.0 SP. GR.

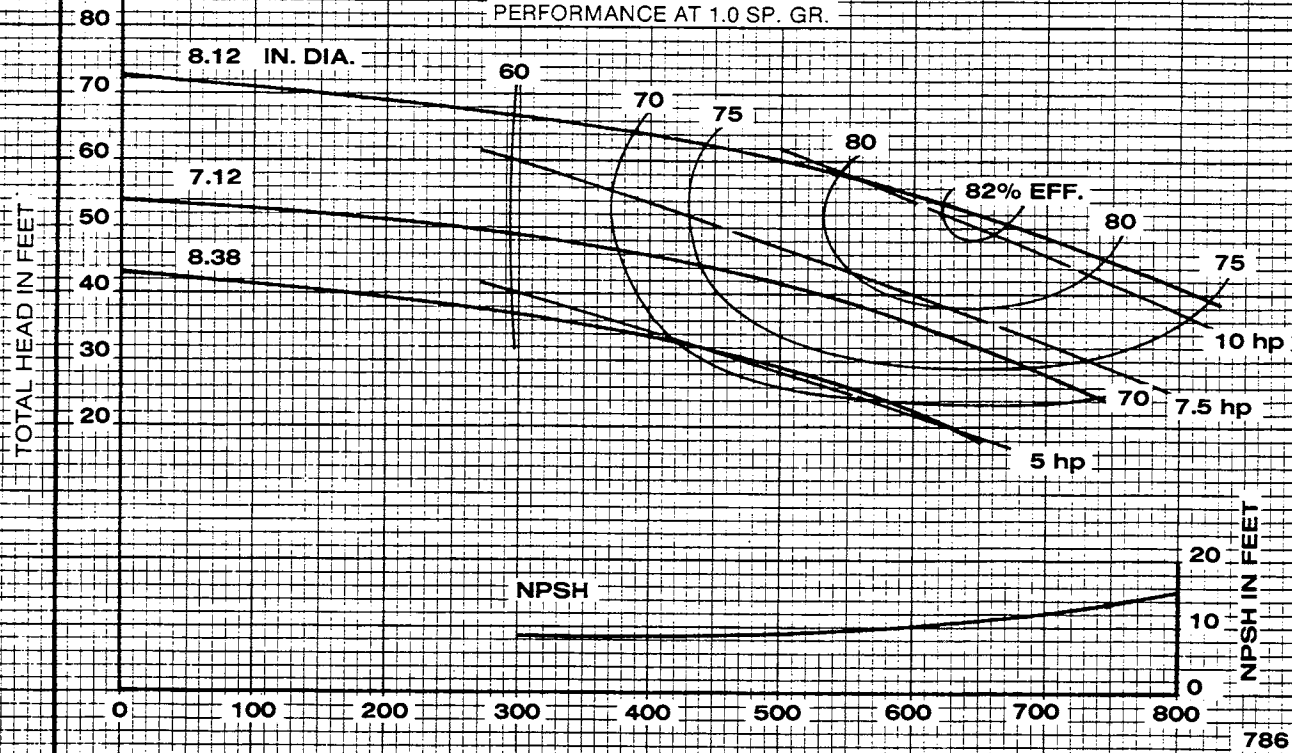

IMPELLER 2693814

U.S. GALLONS PER MINUTE

CURVE 3132016

3550 RPM

VELOCITY HEAD INCLUDED
TOTAL EYE AREA 26.3 SQ. IN.
SPHERE SIZE .62 IN.
PERFORMANCE AT 1.0 SP. GR.

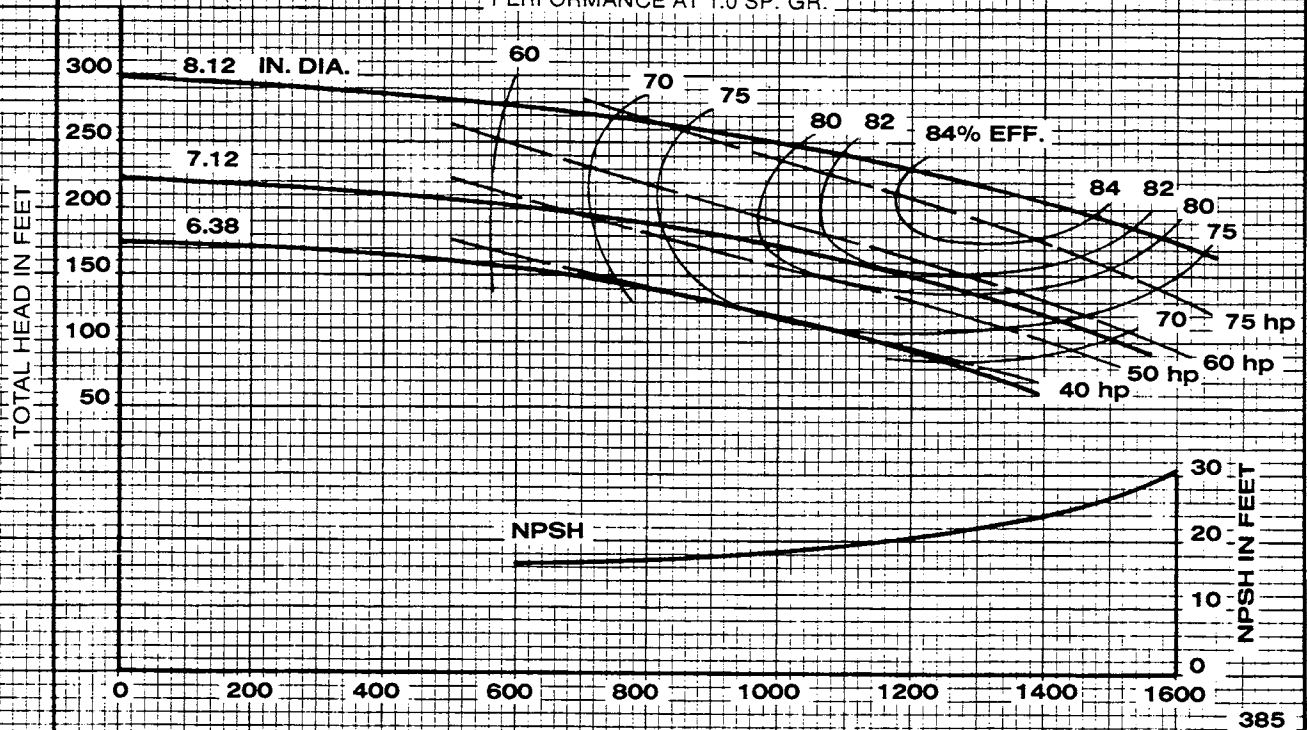

IMPELLER 2693814

U.S. GALLONS PER MINUTE

CURVE 3112022



Peerless Pump Company
Indianapolis, IN 46207-7025

HORIZONTAL SPLIT CASE PUMPS
Type 5AE8N Size 5 x 6 x 8.25

SECTION 1240

1750 RPM

VELOCITY HEAD INCLUDED
TOTAL EYE AREA 24.7 SQ. IN.
SPHERE SIZE .63 IN.
PERFORMANCE AT 1.0 SP. GR.

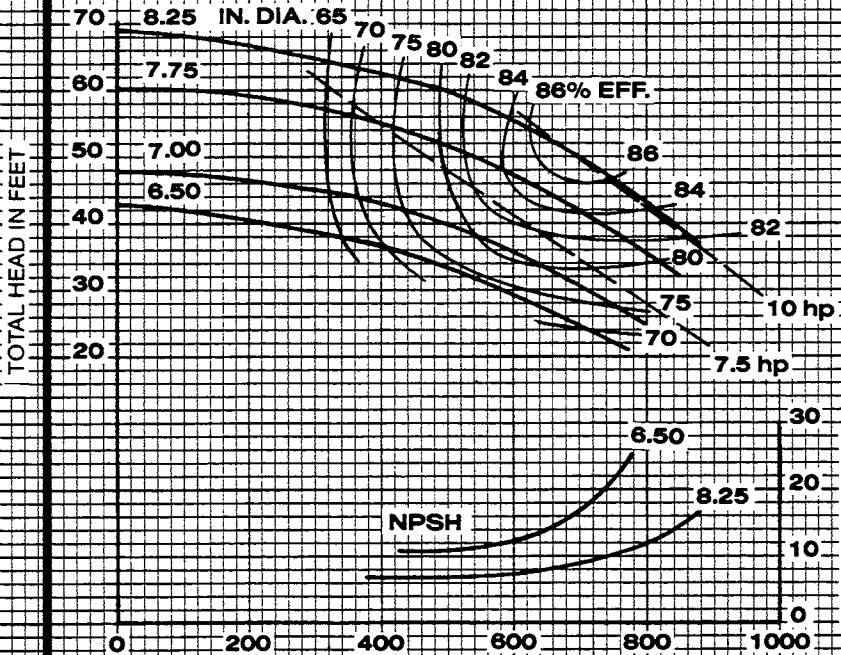

IMPELLER 2693816

U.S. GALLONS PER MINUTE

CURVE 3132107

3550 RPM

VELOCITY HEAD INCLUDED
TOTAL EYE AREA 24.7 SQ. IN.
SPHERE SIZE .63 IN.
PERFORMANCE AT 1.0 SP. GR.

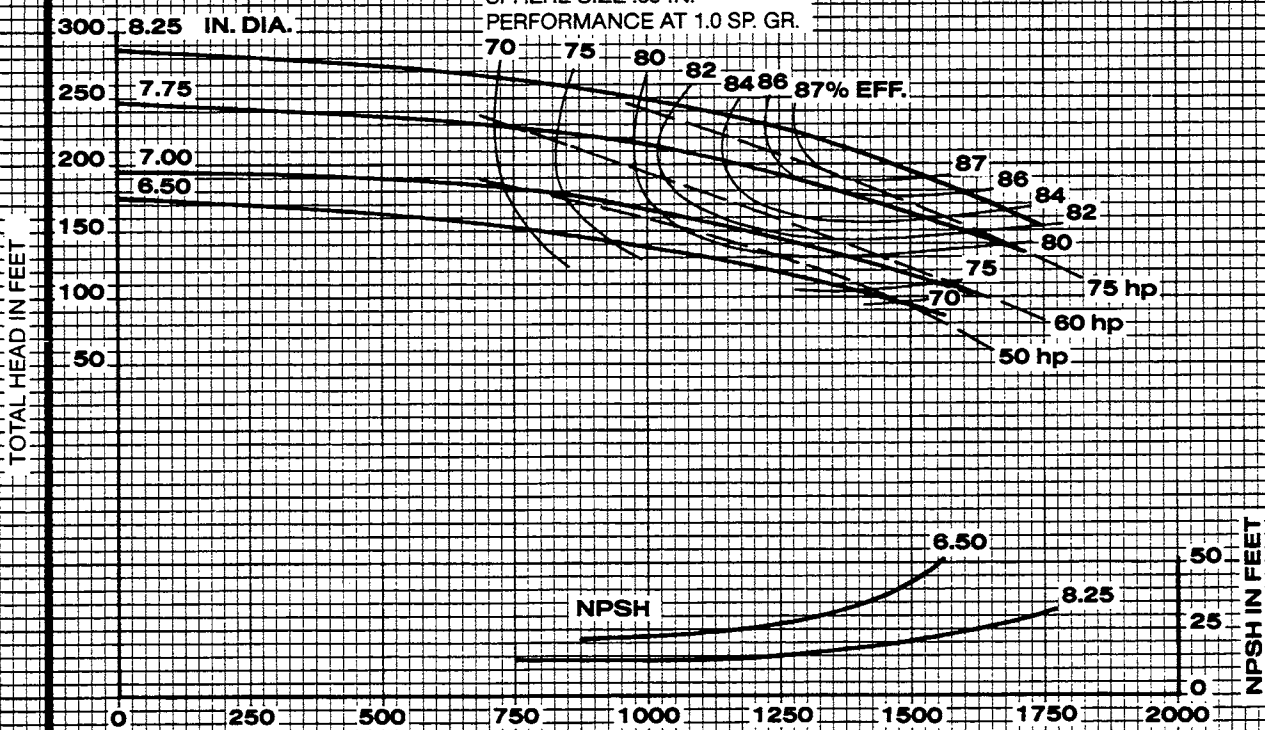

IMPELLER 2693816

U.S. GALLONS PER MINUTE

CURVE 3132105

1750 RPM

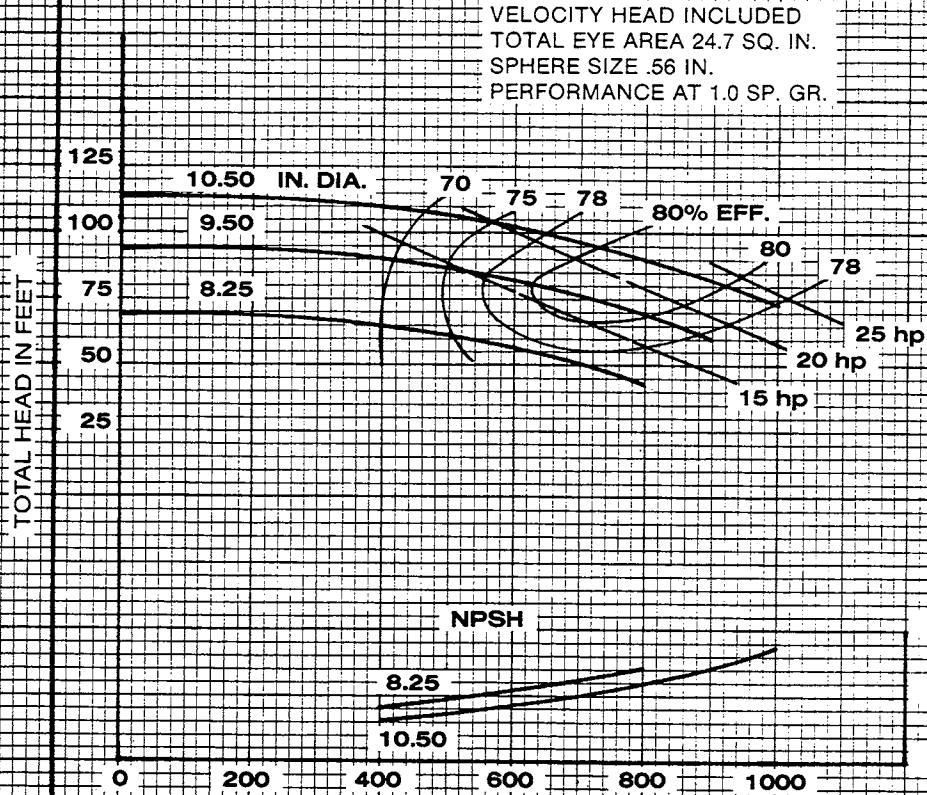

487

IMPELLER **2693430**

U.S. GALLONS PER MINUTE

CURVE **3132052**

3550 RPM

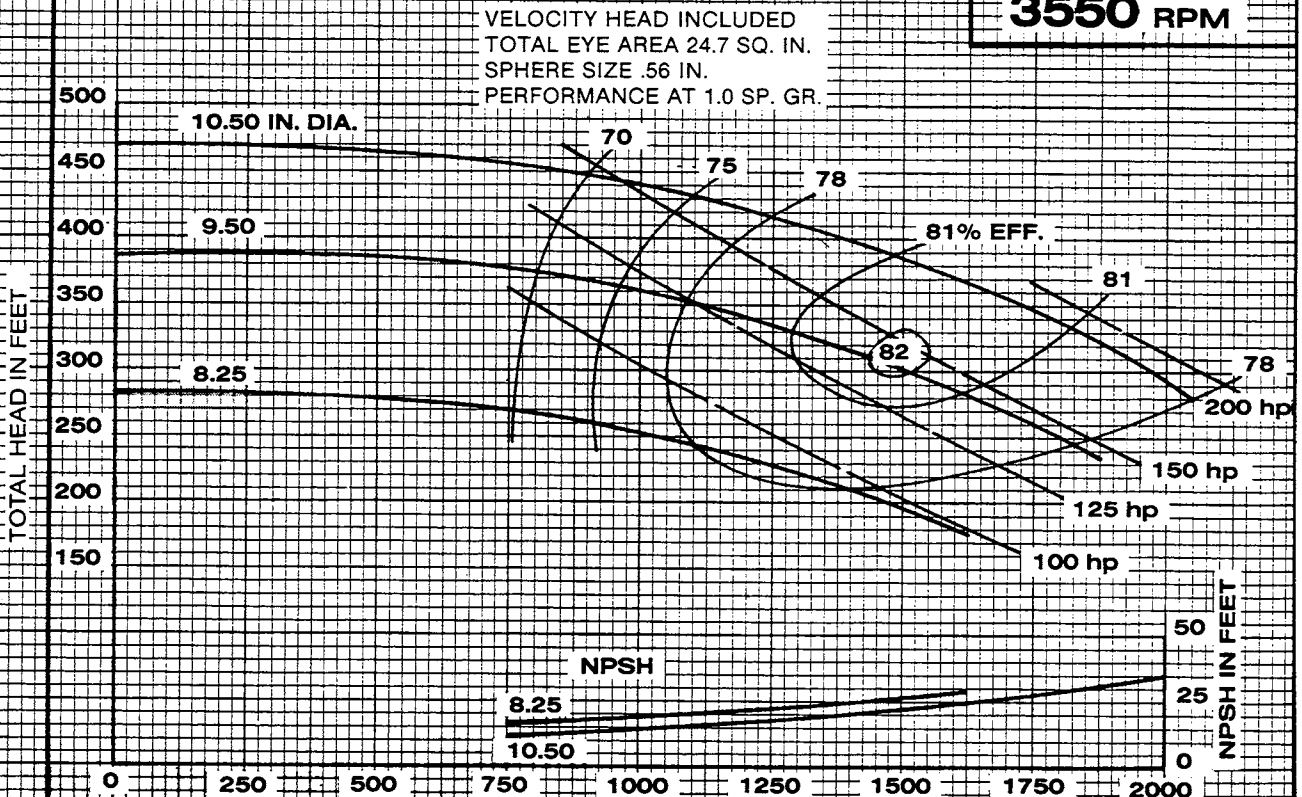

487

IMPELLER **2693430**

U.S. GALLONS PER MINUTE

CURVE **3132050**



Peerless Pump Company
Indianapolis, IN 46207-7026

HORIZONTAL SPLIT CASE PUMPS
Type 5AE11G Size 5x6x10.50

SECTION 1240

1760 RPM

VELOCITY HEAD INCLUDED
TOTAL EYE AREA 23.5 SQ. IN.
SPHERE SIZE .69 IN.
PERFORMANCE AT 1.0 SP. GR.

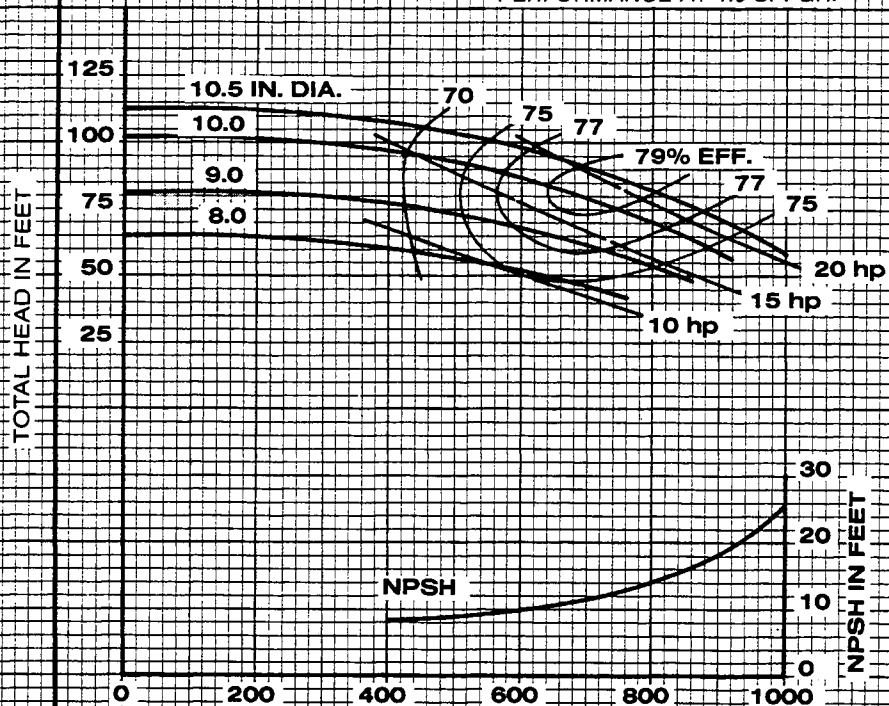

1087

IMPELLER 2693431

U.S. GALLONS PER MINUTE

CURVE 3132086

3550 RPM

VELOCITY HEAD INCLUDED
TOTAL EYE AREA 23.5 SQ. IN.
SPHERE SIZE .69 IN.
PERFORMANCE AT 1.0 SP. GR.

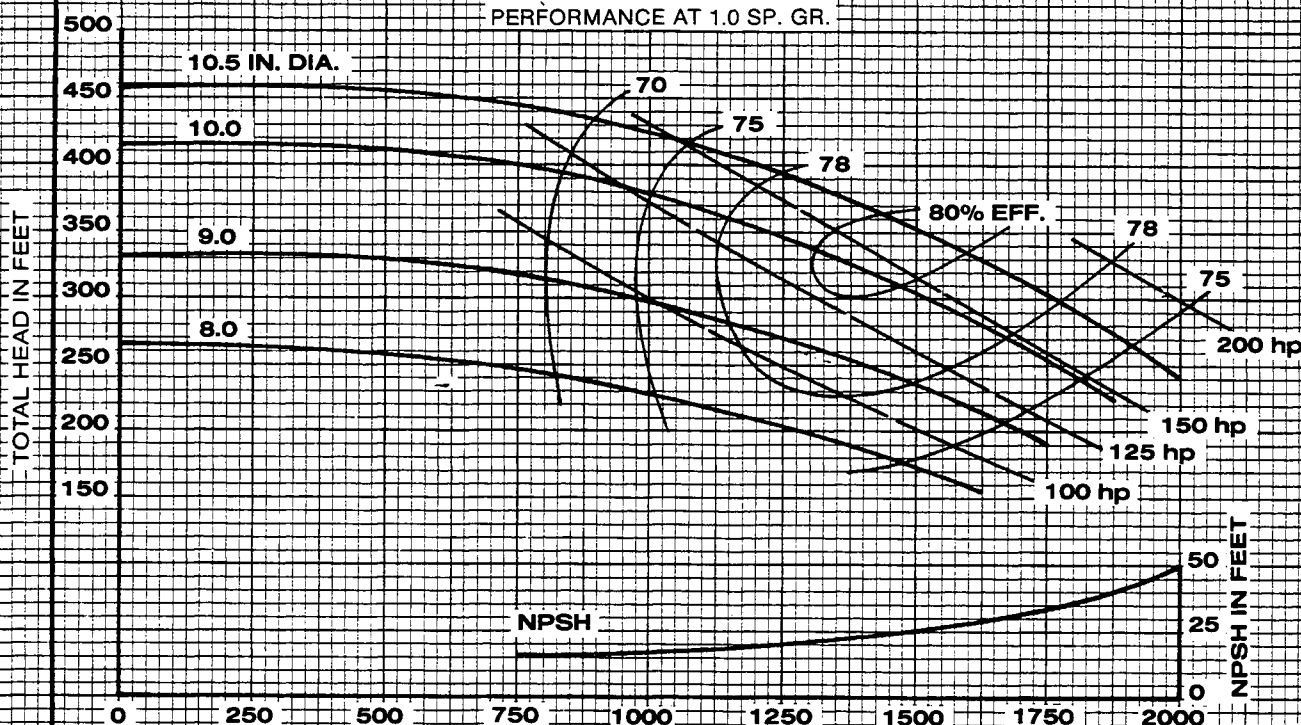

1087

IMPELLER 2693431

U.S. GALLONS PER MINUTE

CURVE 3132084



Peerless Pump Company
Indianapolis, IN 46207-7026

HORIZONTAL SPLIT CASE PUMPS
Type 5AE12 Size 5x6x12.00

SECTION 1240

1765 RPM

VELOCITY HEAD INCLUDED
TOTAL EYE AREA 30.3 SQ. IN.
SPHERE SIZE .63 IN.
PERFORMANCE AT 1.0 SP. GR.

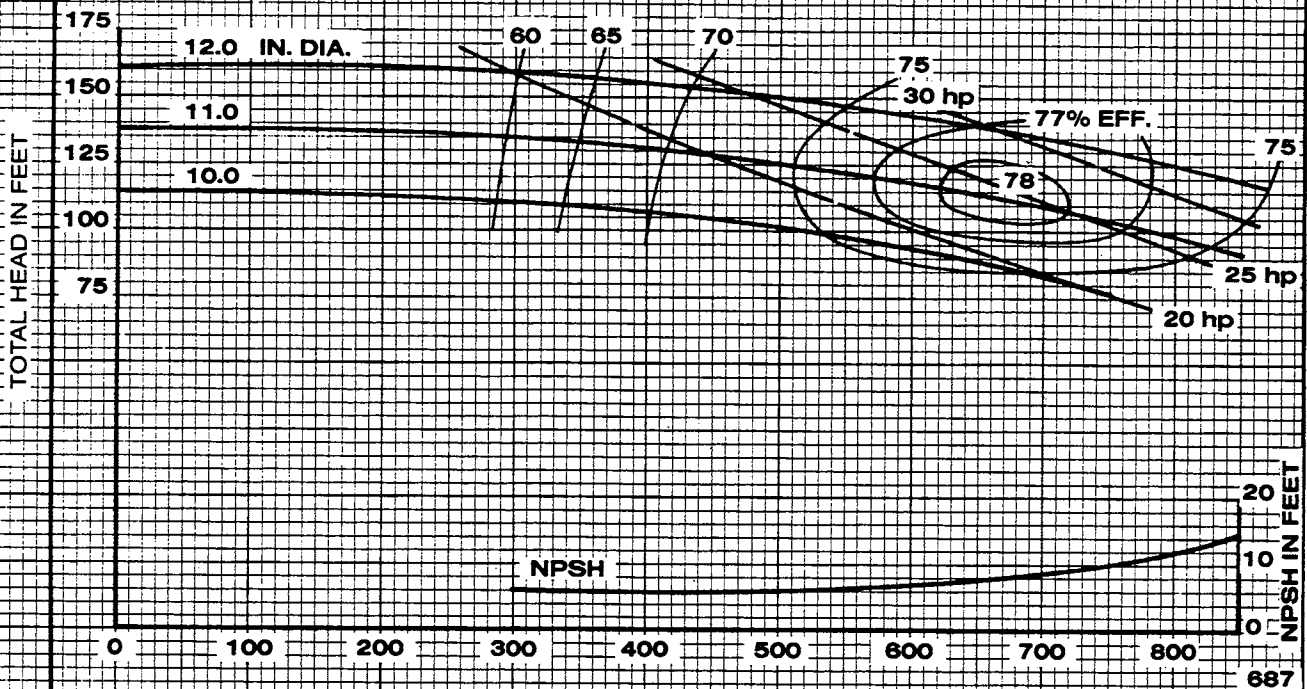

IMPELLER 2693460

U.S. GALLONS PER MINUTE

CURVE 3132068

3550 RPM

VELOCITY HEAD INCLUDED
TOTAL EYE AREA 30.3 SQ. IN.
SPHERE SIZE .63 IN.
PERFORMANCE AT 1.0 SP. GR.

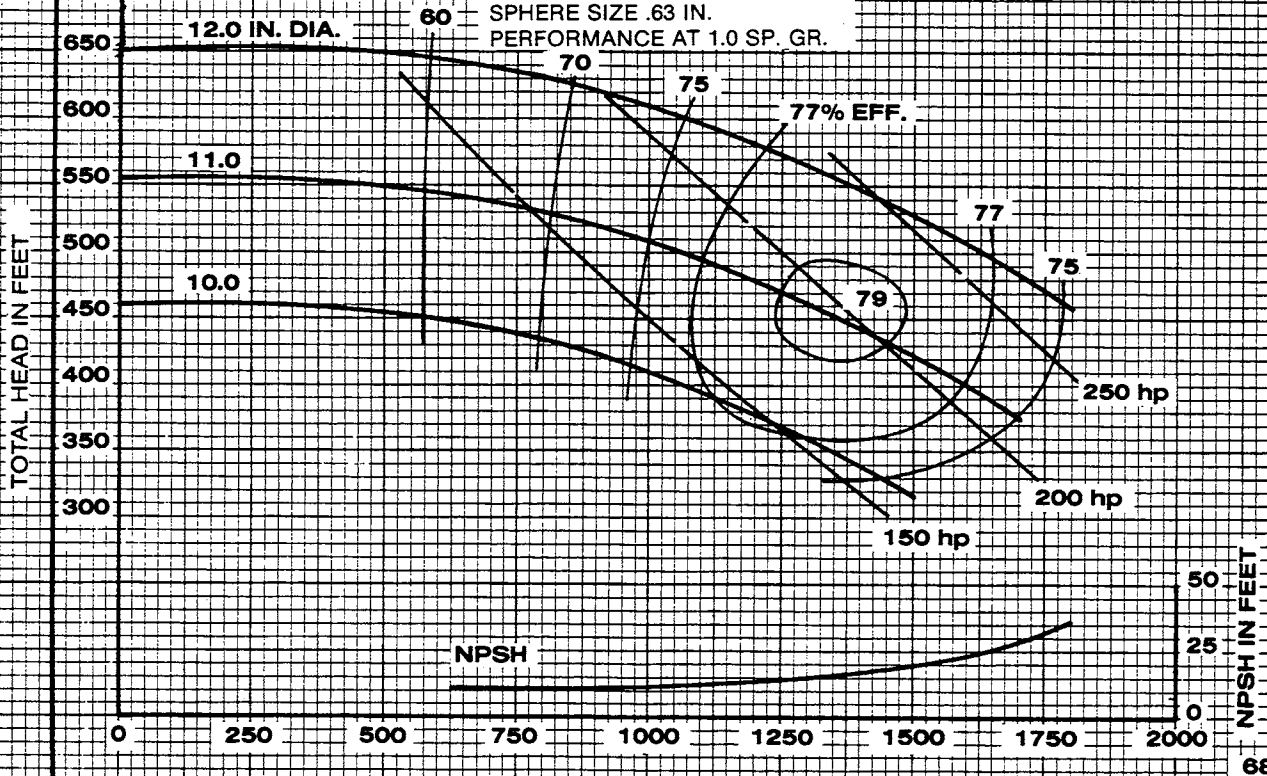

IMPELLER 2693460

U.S. GALLONS PER MINUTE

CURVE 3132068



Peerless Pump Company
Indianapolis, IN 46207-7026

HORIZONTAL SPLIT CASE PUMPS
Type 5AE14 Size 5x6x14.00

SECTION 1240

1150 RPM

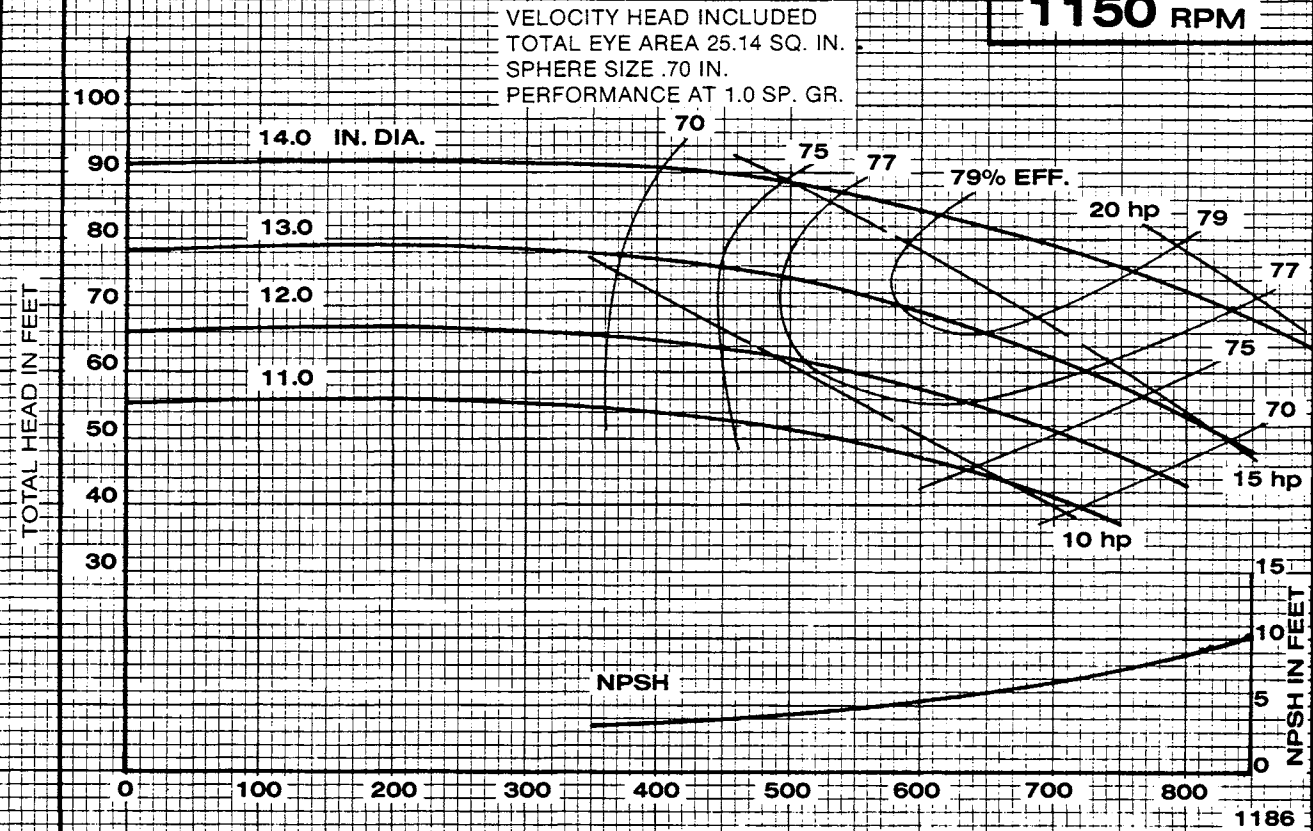

IMPELLER 2693456

U.S. GALLONS PER MINUTE

CURVE 3132032

1760 RPM

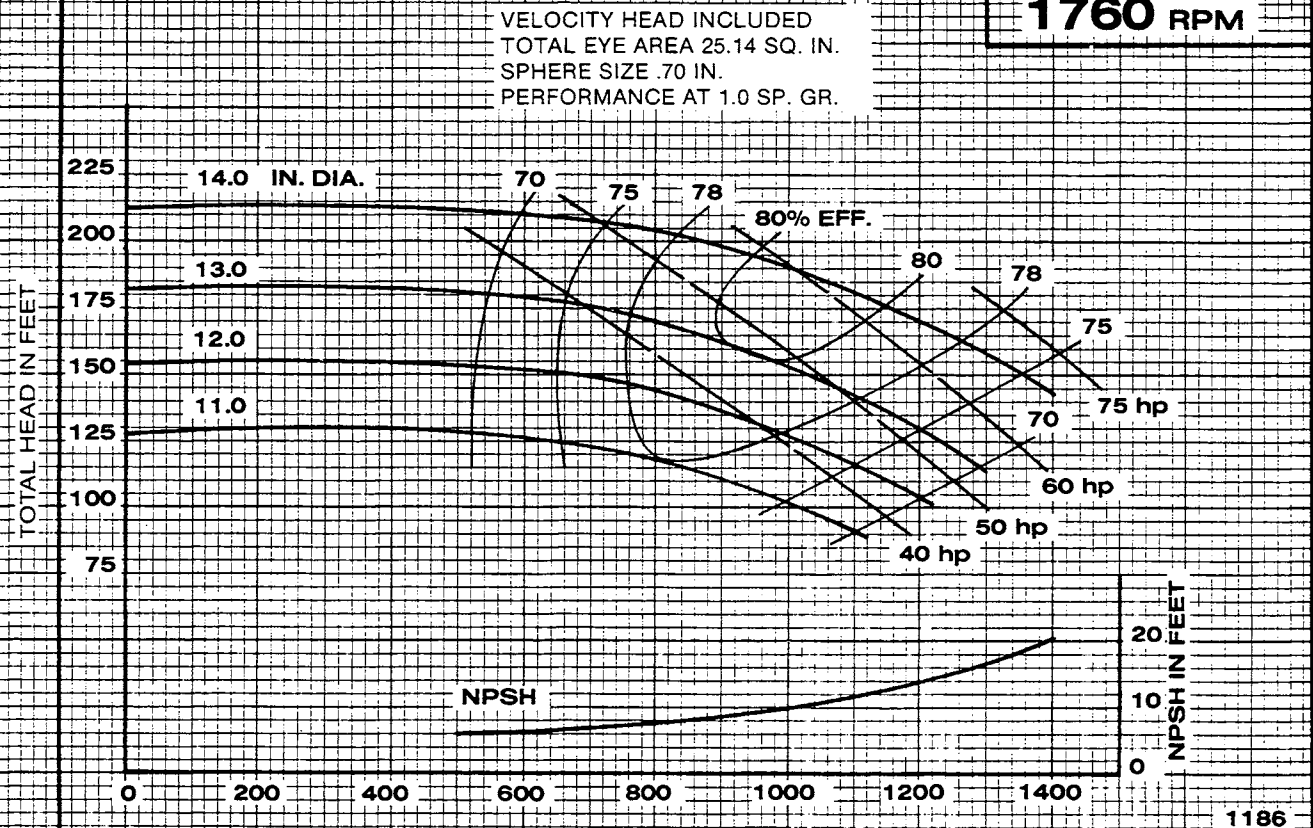

IMPELLER 2693456

U.S. GALLONS PER MINUTE

CURVE 3132030



Peerless Pump Company
Indianapolis, IN 46207-7026

HORIZONTAL SPLIT CASE PUMPS
Type 5AE14G Size 5 x 6 x 14.00

SECTION 1240

1150 RPM

VELOCITY HEAD INCLUDED
TOTAL EYE AREA 17.5 SQ. IN.
SPHERE SIZE .53 IN.
PERFORMANCE AT 1.0 SP. GR.

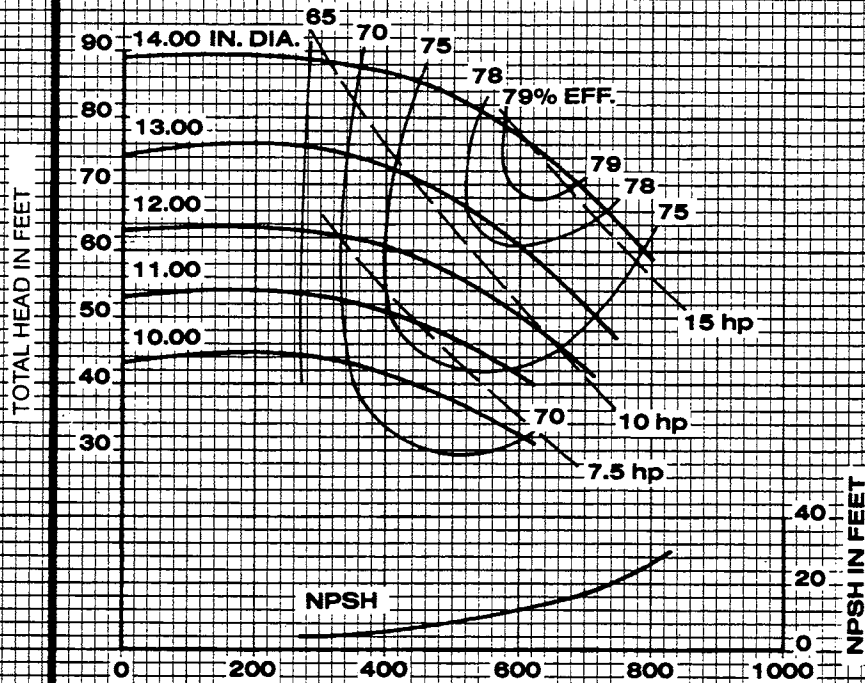

688

IMPELLER 2694349

U.S. GALLONS PER MINUTE

CURVE 3132102

1750 RPM

VELOCITY HEAD INCLUDED
TOTAL EYE AREA 17.5 SQ. IN.
SPHERE SIZE .53 IN.
PERFORMANCE AT 1.0 SP. GR.

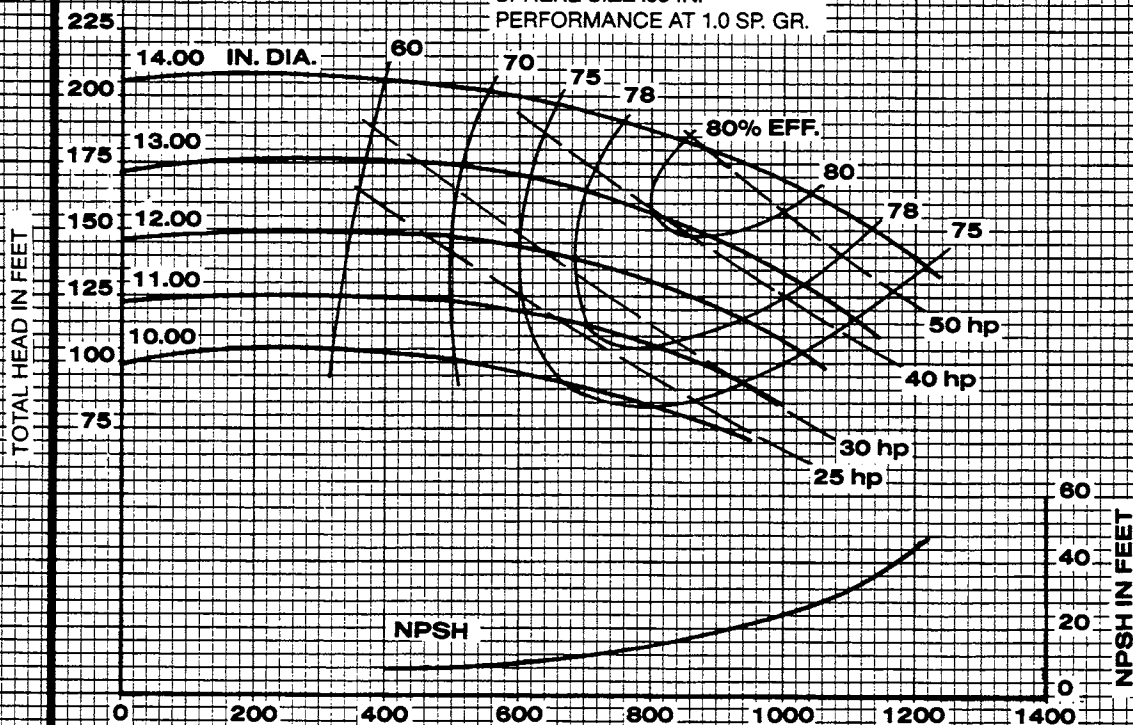

688

IMPELLER 2694349

U.S. GALLONS PER MINUTE

CURVE 3132100

1150 RPM

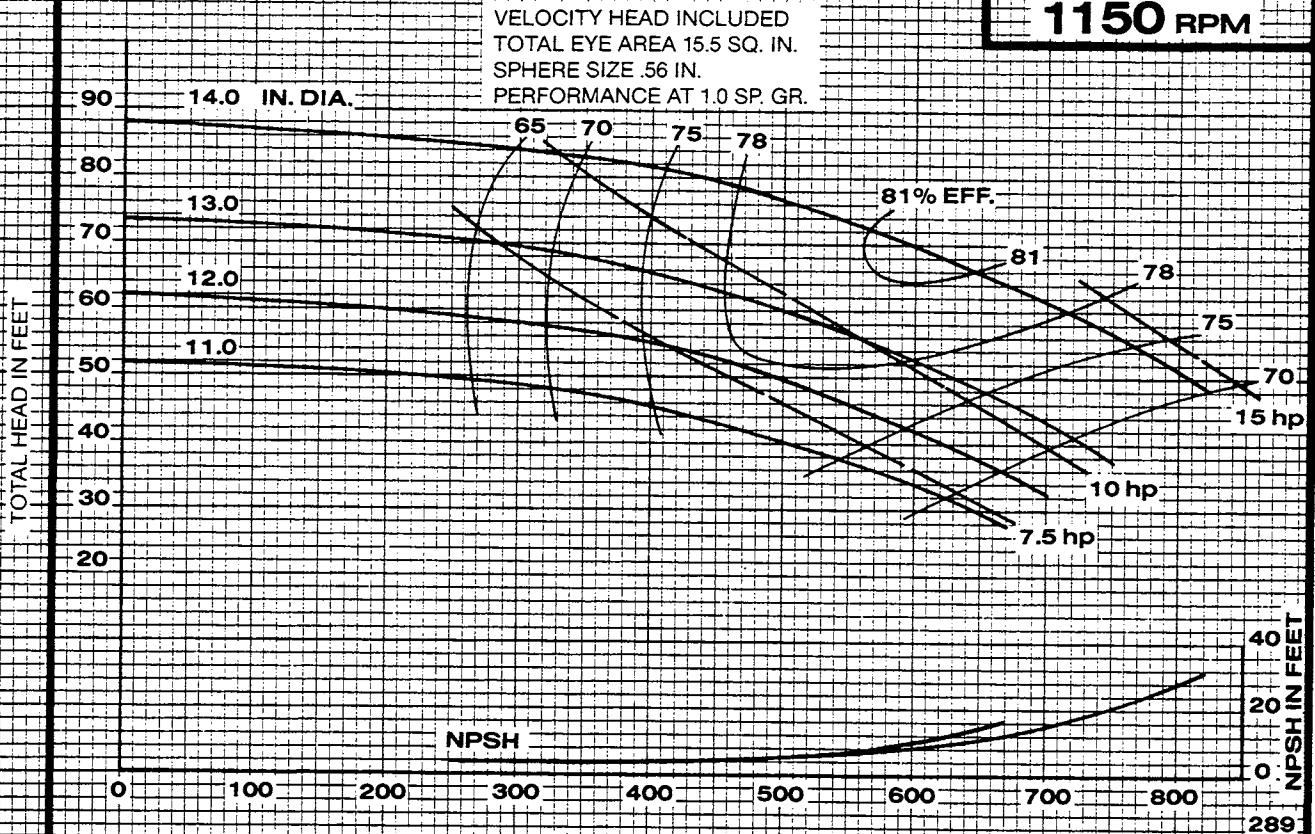

IMPELLER 2694394

U.S. GALLONS PER MINUTE

CURVE 3132116

1750 RPM

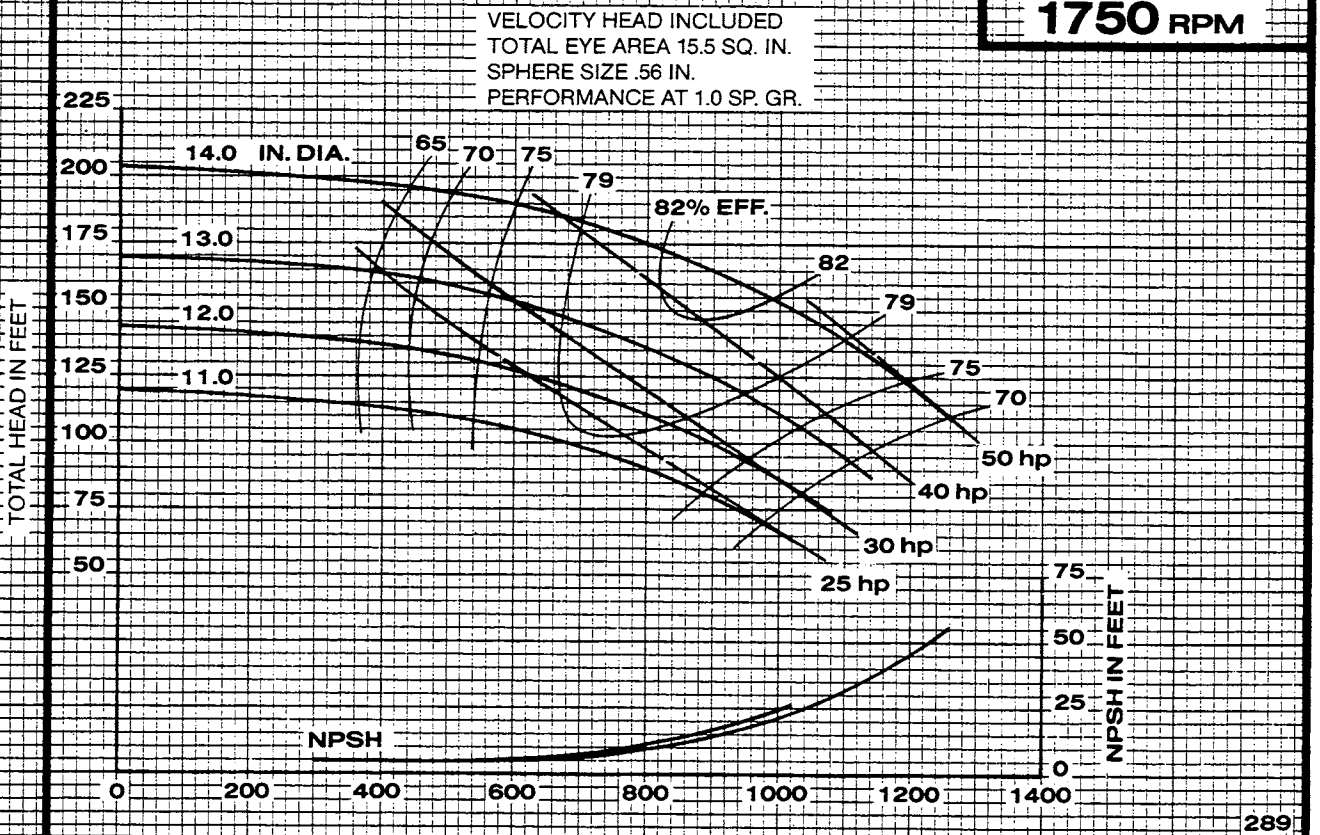

IMPELLER 2694394

U.S. GALLONS PER MINUTE

CURVE 3132114

1150 RPM

VELOCITY HEAD INCLUDED
TOTAL EYE AREA 33.0 SQ. IN.
SPHERE SIZE .95 IN.
PERFORMANCE AT 1.0 SP. GR.

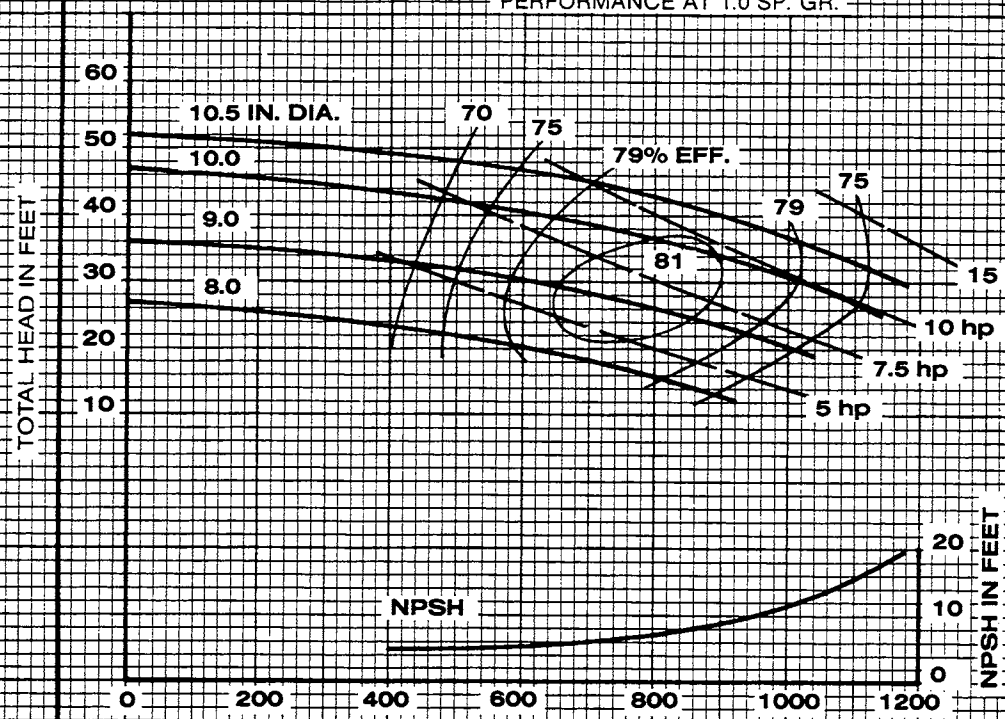

186

IMPELLER 2692848

U.S. GALLONS PER MINUTE

CURVE 3112034

1750 RPM

VELOCITY HEAD INCLUDED
TOTAL EYE AREA 33.0 SQ. IN.
SPHERE SIZE .95 IN.
PERFORMANCE AT 1.0 SP. GR.

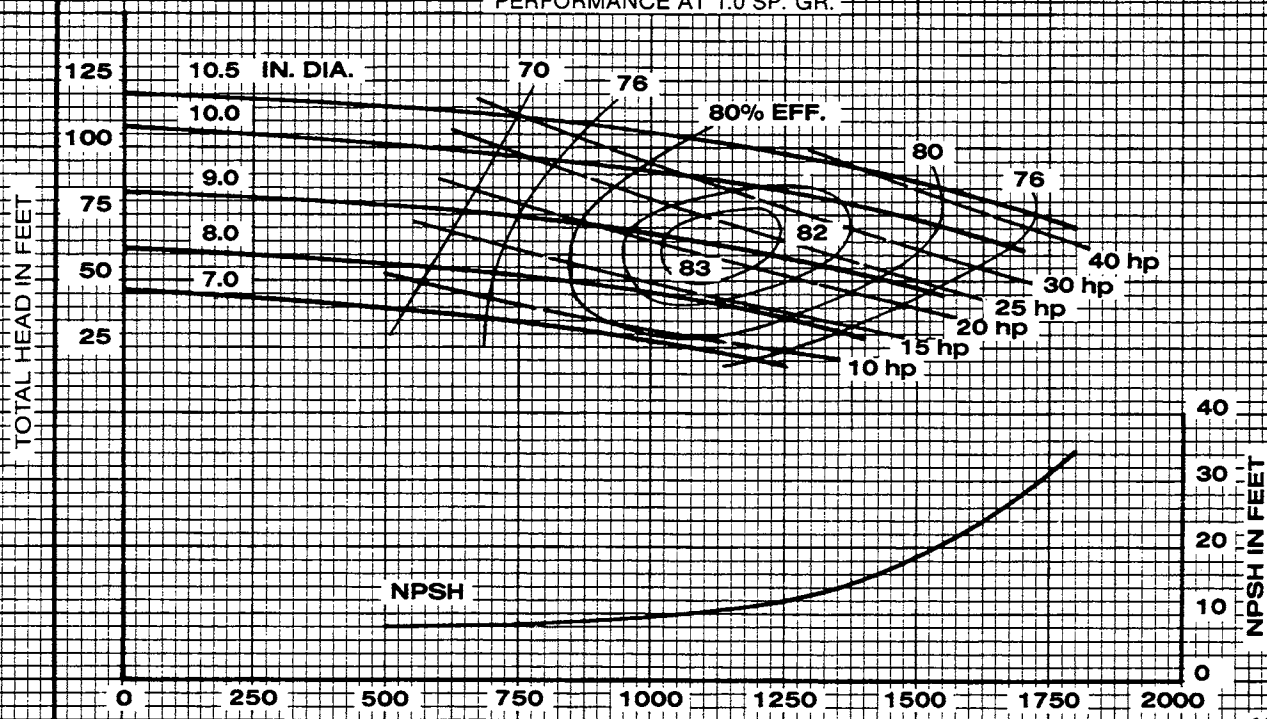

186

IMPELLER 2692848

U.S. GALLONS PER MINUTE

CURVE 3112032



Peerless Pump Company
Indianapolis, IN 46207-7026

HORIZONTAL SPLIT CASE PUMPS
Type 6AE12 Size 6x8x12.25

SECTION 1240

1750 RPM

VELOCITY HEAD INCLUDED
TOTAL EYE AREA 45.0 SQ. IN.
SPHERE SIZE .64 IN.
PERFORMANCE AT 1.0 SP. GR.

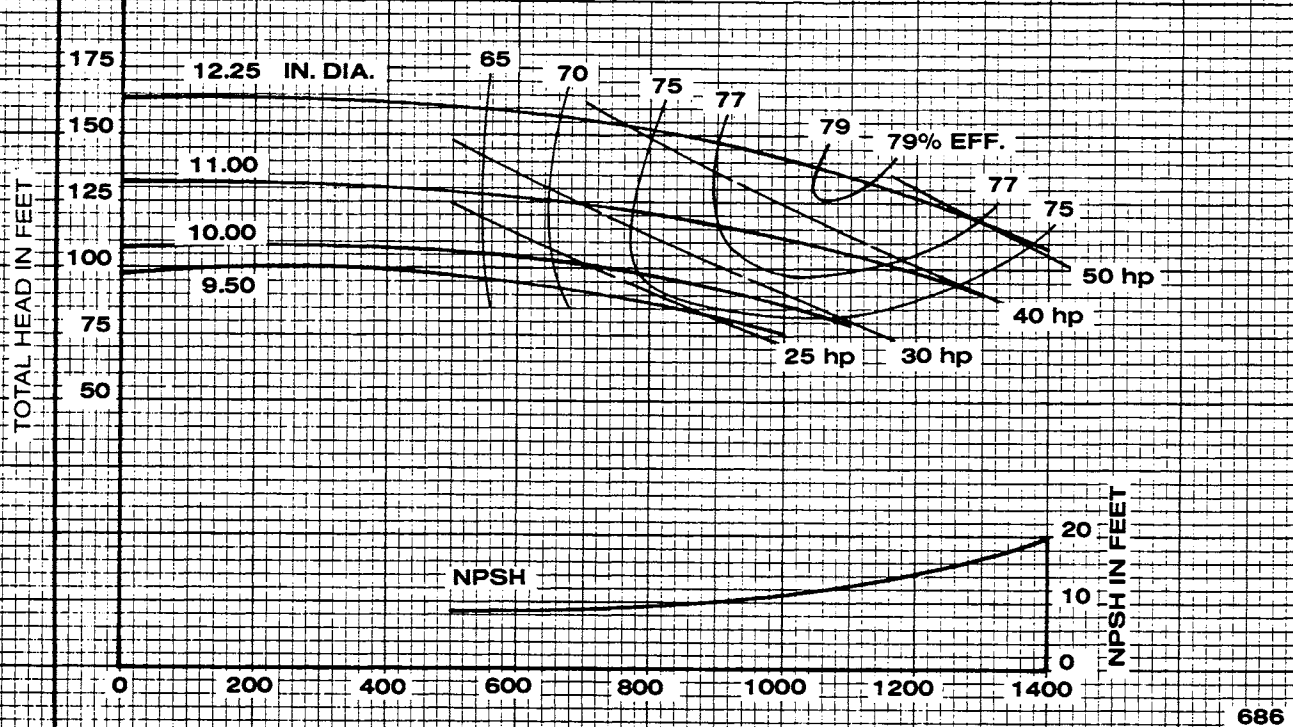

IMPELLER 2692443

U.S. GALLONS PER MINUTE

CURVE 3132008

3550 RPM

VELOCITY HEAD INCLUDED
TOTAL EYE AREA 45.0 SQ. IN.
SPHERE SIZE .64 IN.
PERFORMANCE AT 1.0 SP. GR.

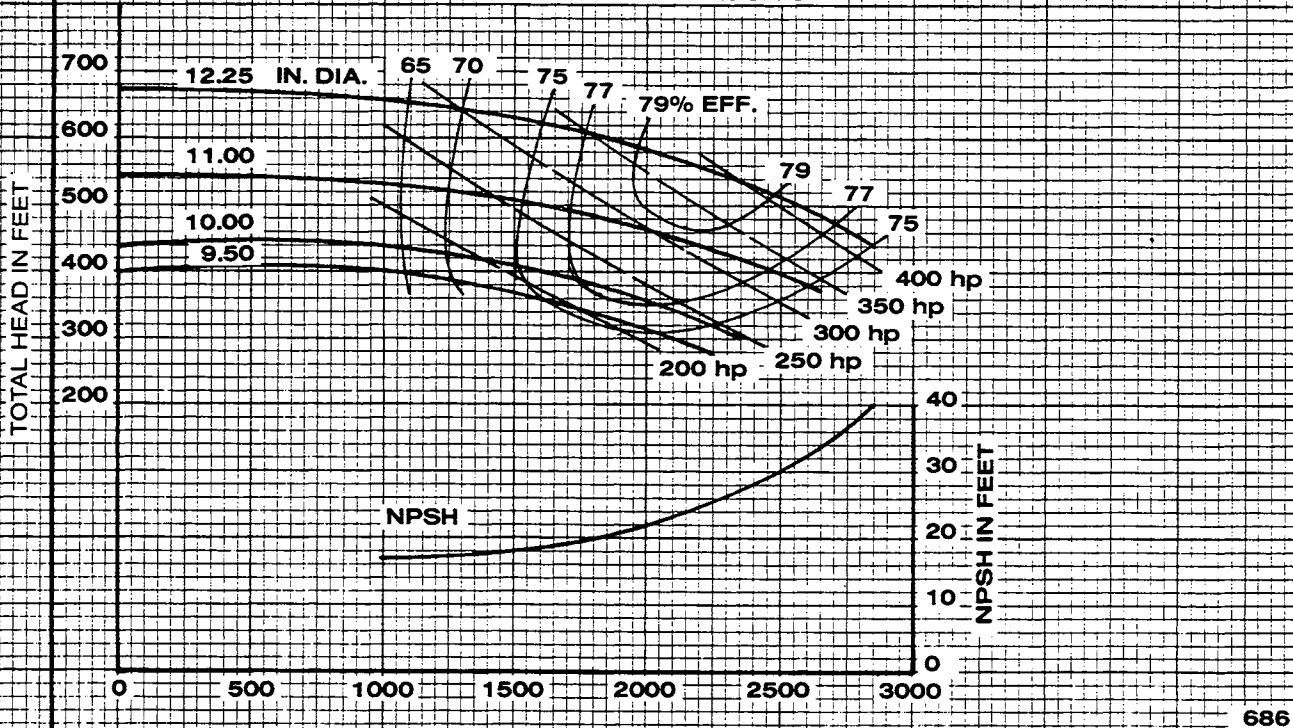

IMPELLER 2692443

U.S. GALLONS PER MINUTE

CURVE 3132006



Peerless Pump Company
Indianapolis, IN 46207-7026

HORIZONTAL SPLIT CASE PUMPS
Type 6AE14 Size 6x8x14.00

SECTION 1240

1150 RPM

VELOCITY HEAD INCLUDED
TOTAL EYE AREA 30.63 SQ. IN.
SPHERE SIZE .75 IN.
PERFORMANCE AT 1.0 SP. GR.

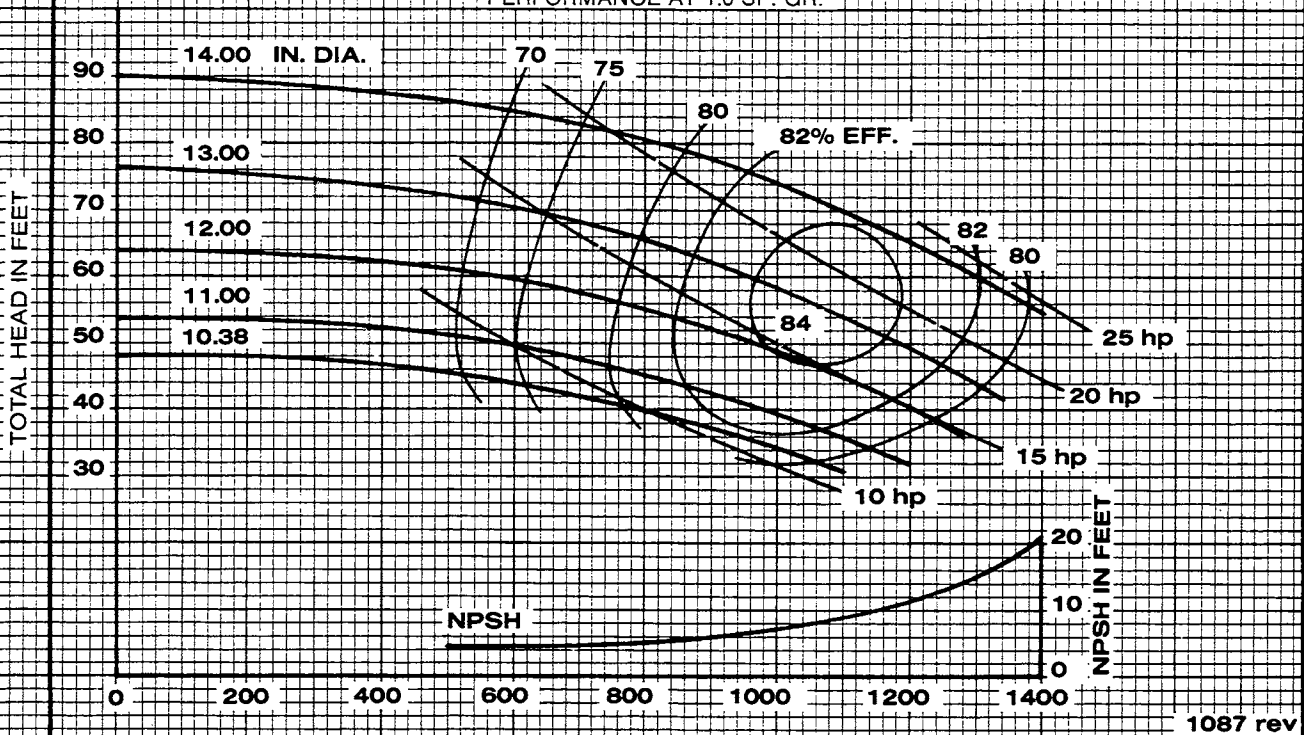

IMPELLER 2693077

U.S. GALLONS PER MINUTE

CURVE 3132029

1750 RPM

VELOCITY HEAD INCLUDED
TOTAL EYE AREA 30.63 SQ. IN.
SPHERE SIZE .75 IN.
PERFORMANCE AT 1.0 SP. GR.

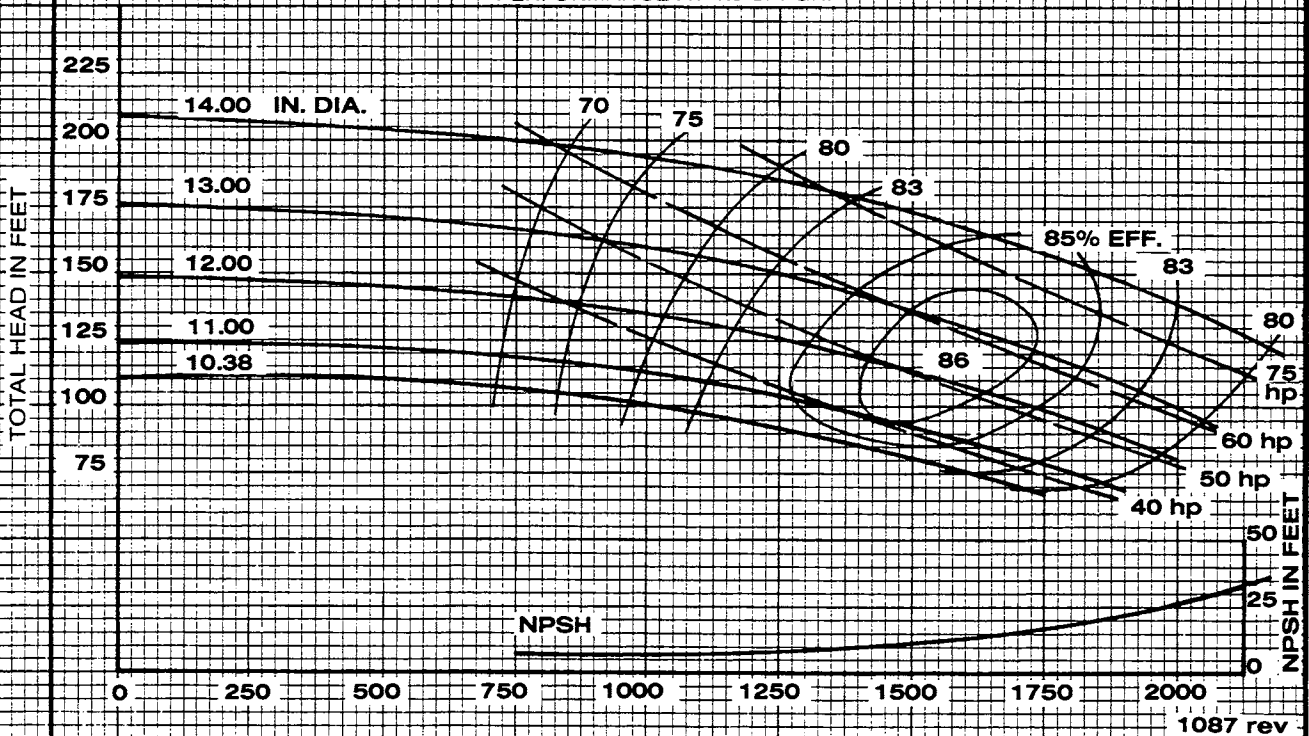

IMPELLER 2693077

U.S. GALLONS PER MINUTE

CURVE 3132027



Peerless Pump Company
Indianapolis, IN 46207-7026

HORIZONTAL SPLIT CASE PUMPS
Type 6AE14G Size 6x8x14.00

SECTION 1240

1150 RPM

VELOCITY HEAD INCLUDED
TOTAL EYE AREA 31.09 SQ. IN.
SPHERE SIZE .98 IN.
PERFORMANCE AT 1.0 SP. GR.

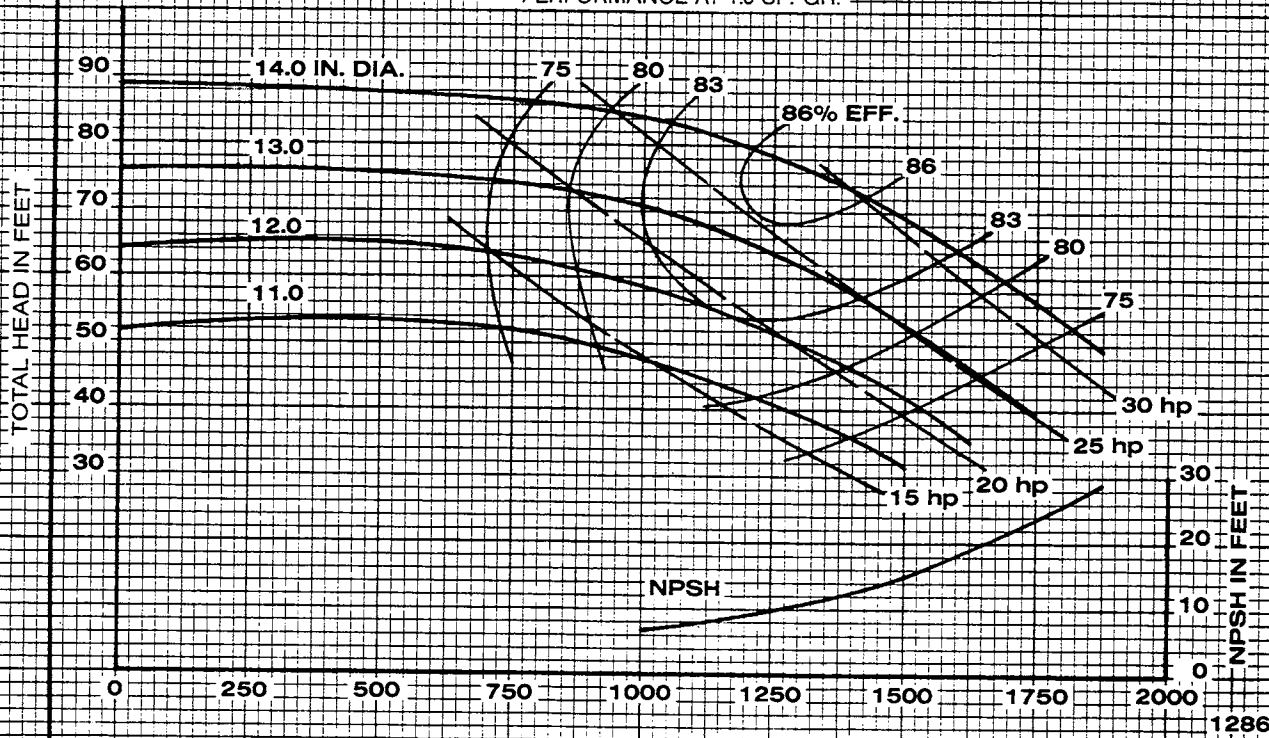

IMPELLER 2693078

U.S. GALLONS PER MINUTE

CURVE 3132035

1760 RPM

VELOCITY HEAD INCLUDED
TOTAL EYE AREA 31.09 SQ. IN.
SPHERE SIZE .98 IN.
PERFORMANCE AT 1.0 SP. GR.

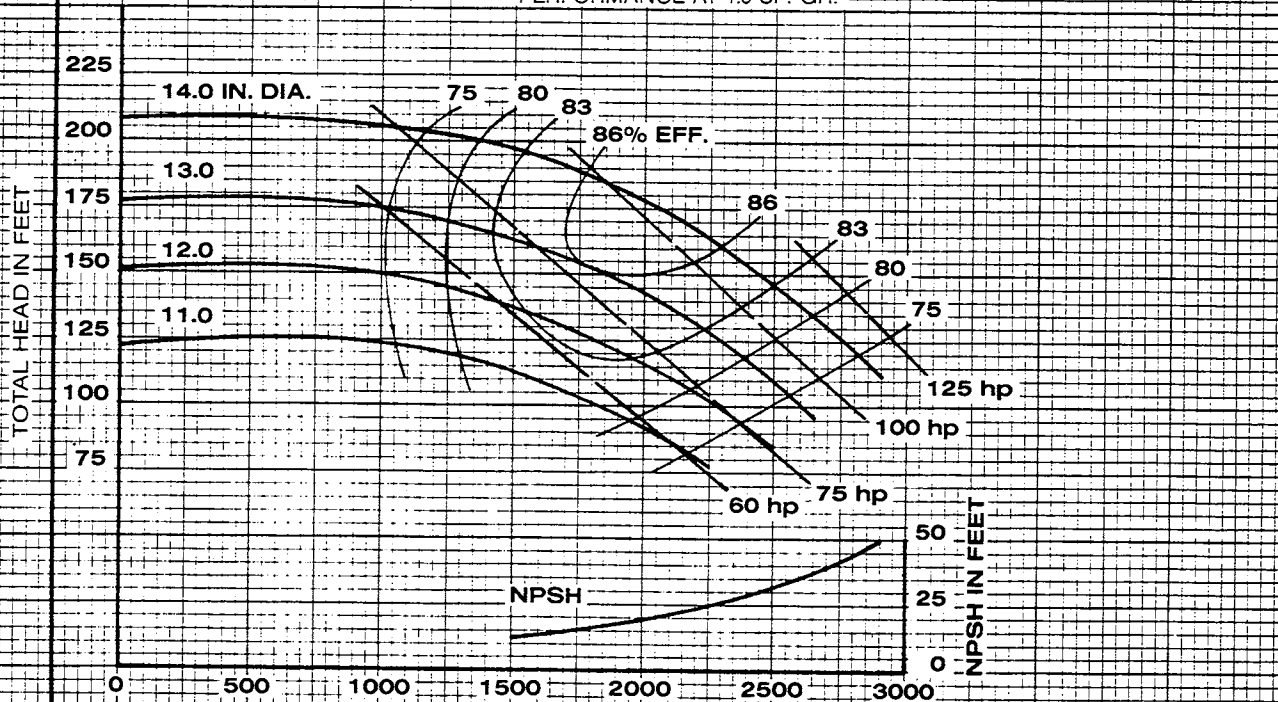

IMPELLER 2693078

U.S. GALLONS PER MINUTE

CURVE 3132033



Peerless Pump Company
Indianapolis, IN 46207-7026

HORIZONTAL SPLIT CASE PUMPS
SINGLE STAGE DOUBLE SUCTION
Type 6AE14N Size 6 x 8 x 15.25

SECTION 1240

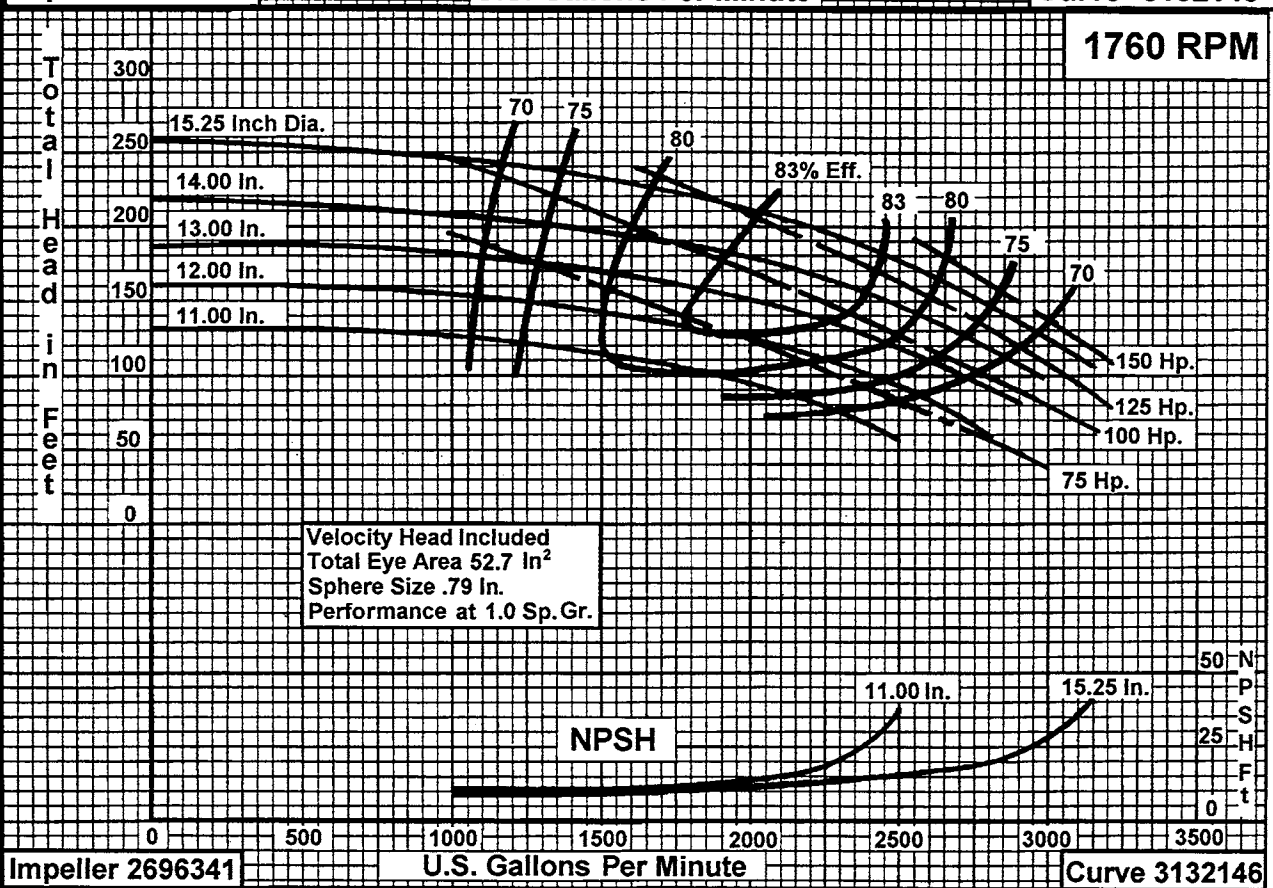
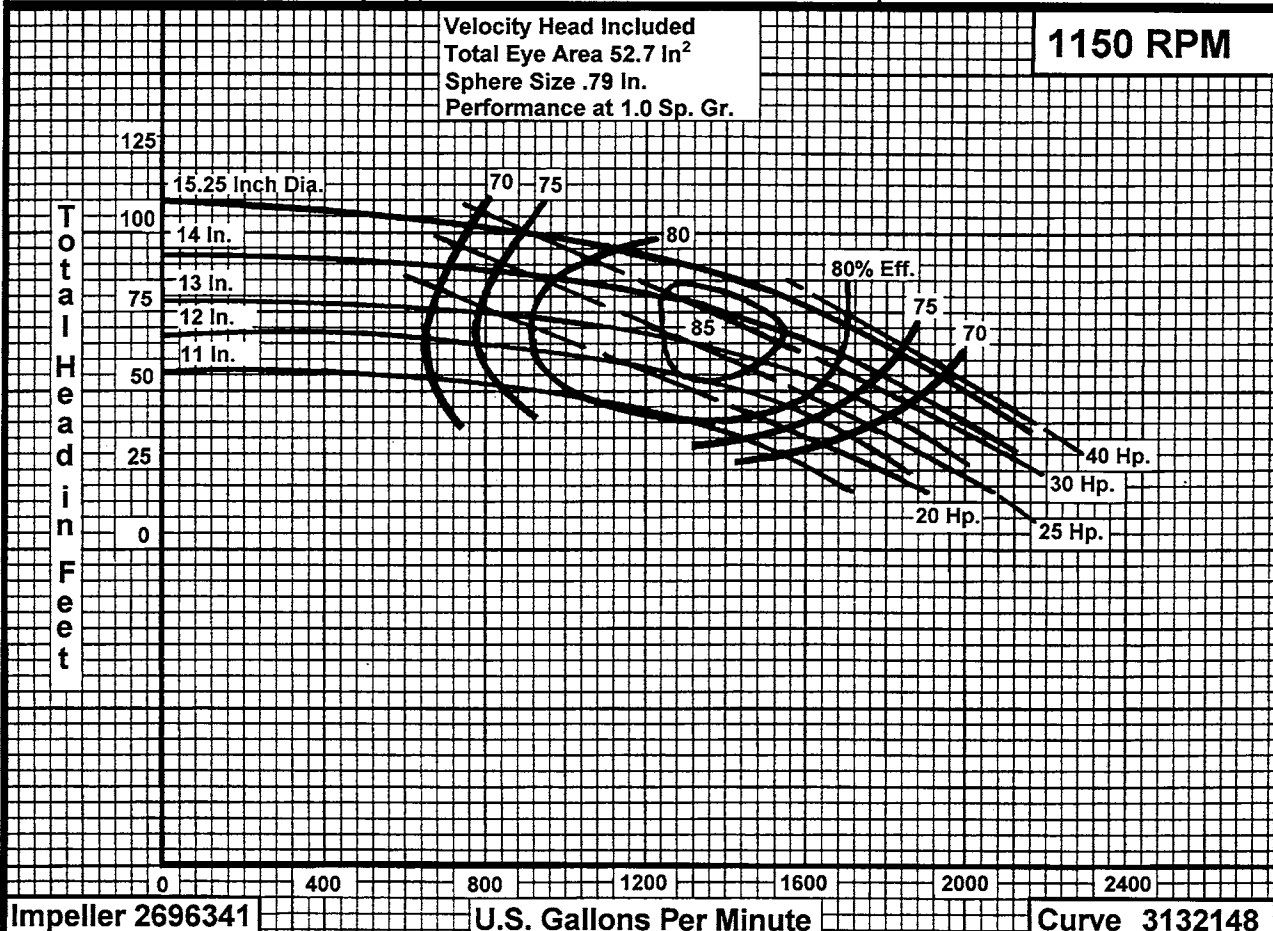



Peerless Pump Company
Indianapolis, IN 46207-7026

HORIZONTAL SPLIT CASE PUMPS
Type 6AE16 Size 6x8x16.75

SECTION 1240

1150 RPM

VELOCITY HEAD INCLUDED
TOTAL EYE AREA 37.69 SQ. IN.
SPHERE SIZE .70 IN.
PERFORMANCE AT 1.0 SP. GR.

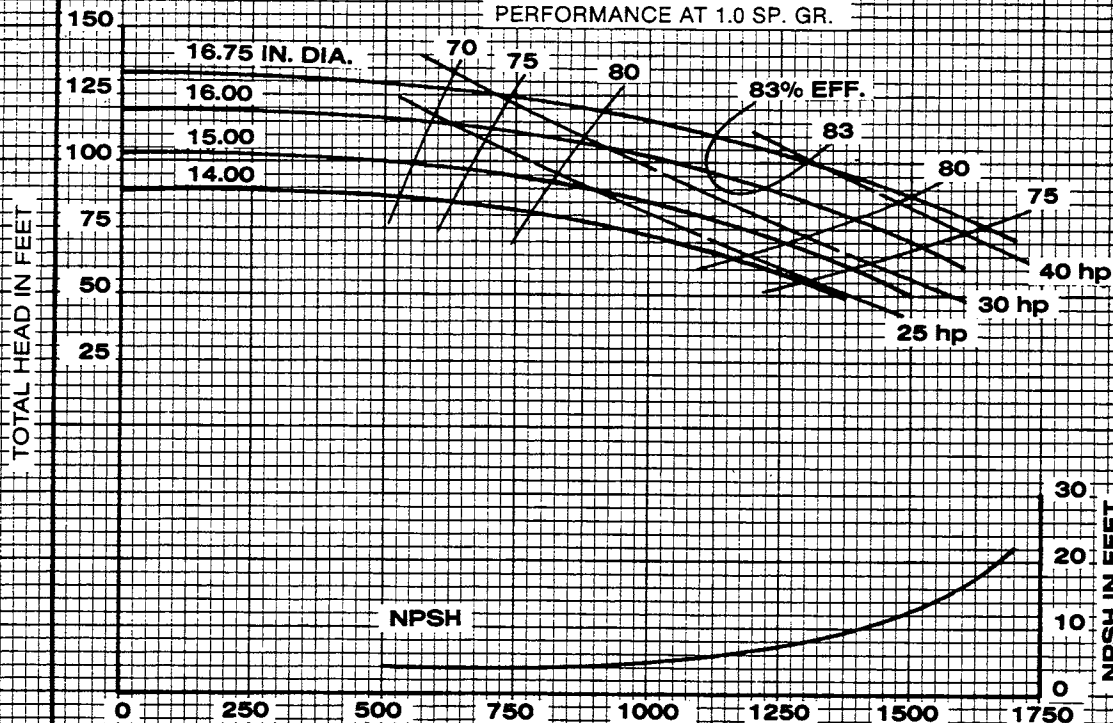

IMPELLER 2692932

U.S. GALLONS PER MINUTE

CURVE 3132055

1760 RPM

VELOCITY HEAD INCLUDED
TOTAL EYE AREA 37.69 SQ. IN.
SPHERE SIZE .70 IN.
PERFORMANCE AT 1.0 SP. GR.

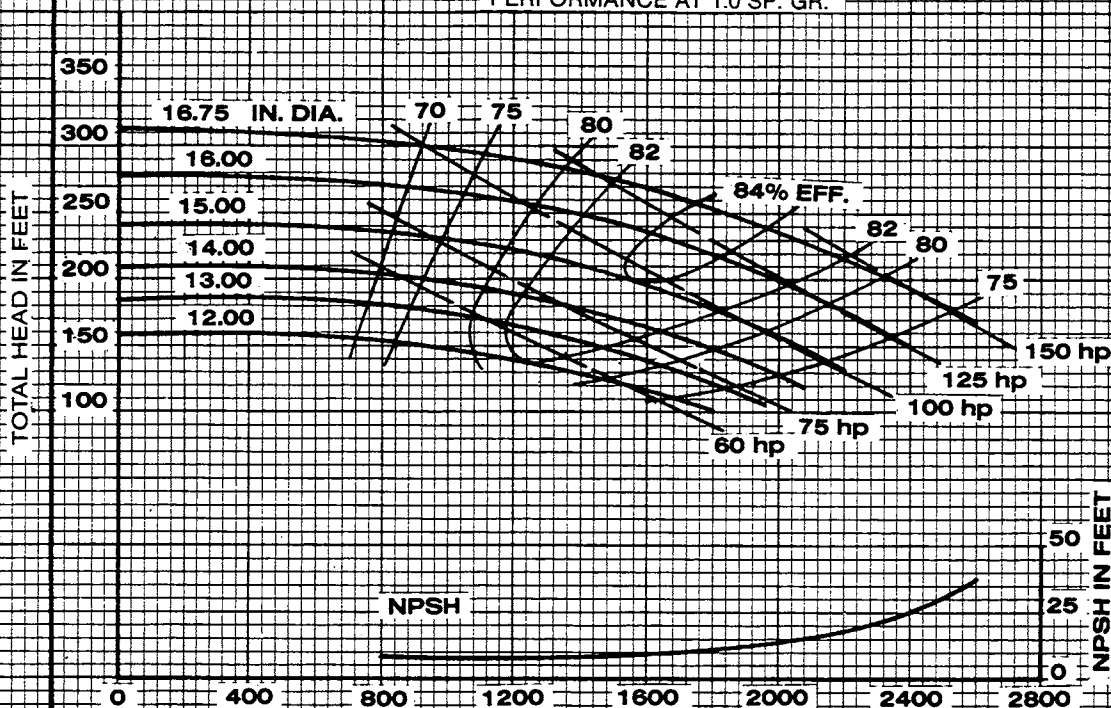

IMPELLER 2692932

U.S. GALLONS PER MINUTE

CURVE 3132053



Peerless Pump Company
Indianapolis, IN 46207-7026

HORIZONTAL SPLIT CASE PUMPS
Type 6AE16G Size 6 x 8 x 16.75

SECTION 1240

1150 RPM

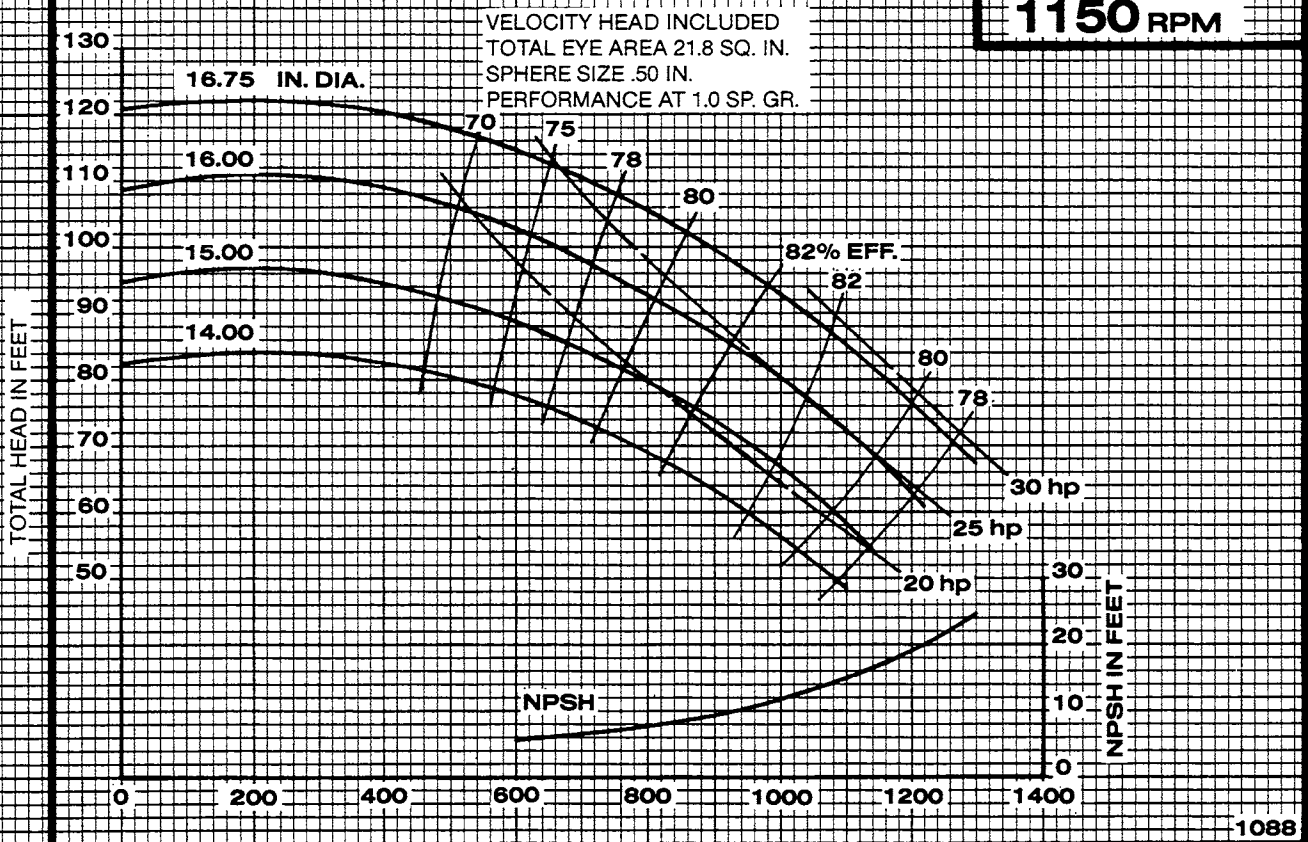

IMPELLER 2692933

U.S. GALLONS PER MINUTE

CURVE 3132110

1760 RPM

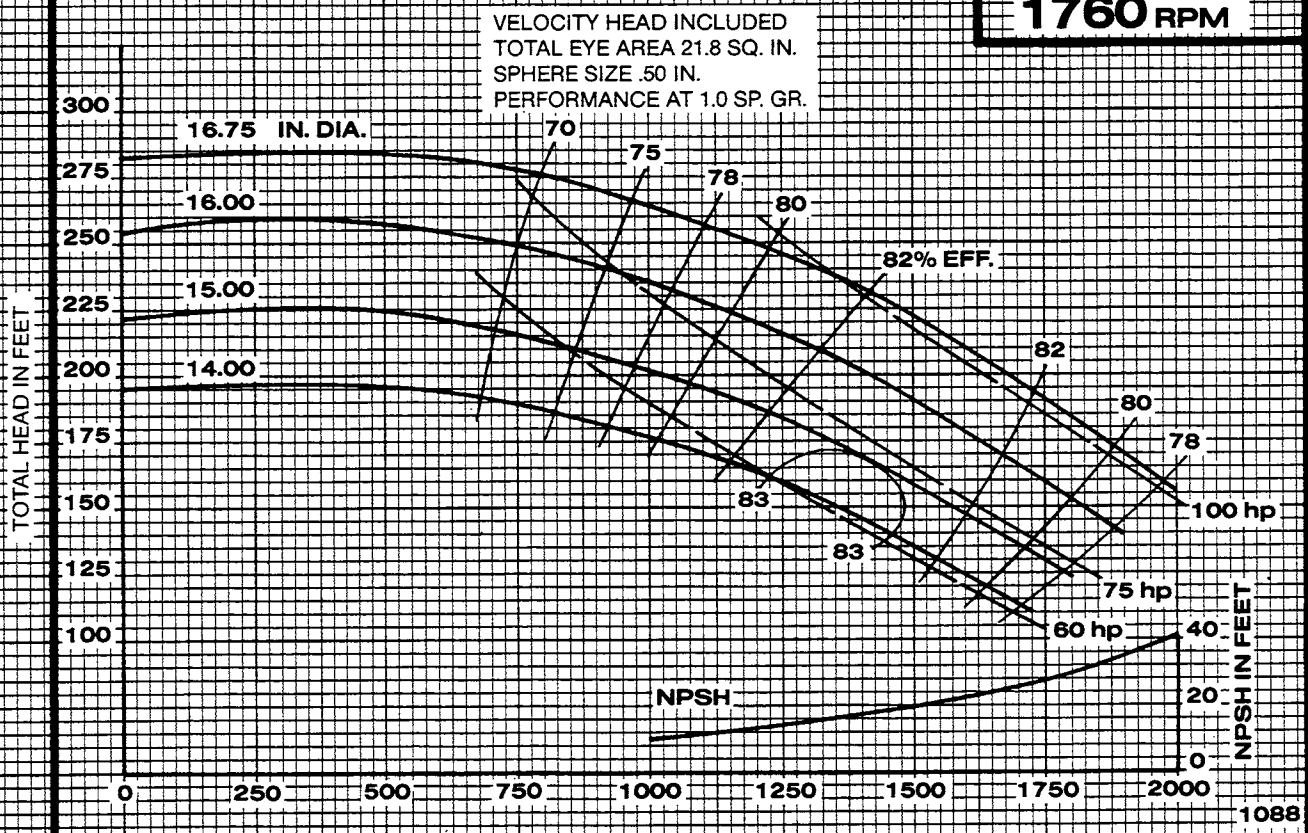

IMPELLER 2692933

U.S. GALLONS PER MINUTE

CURVE 3132108



Peerless Pump Company
Indianapolis, IN 46207-7026

HORIZONTAL SPLIT CASE PUMPS
Type 6AE16V Size 6 x 8 x 17.00

SECTION 1240

1150 RPM

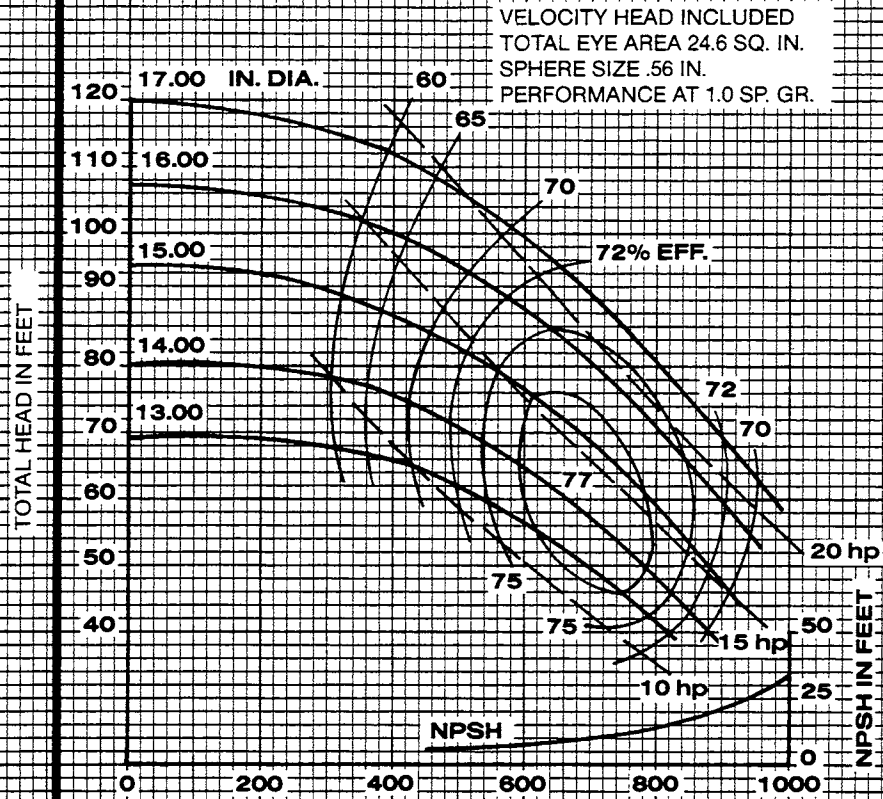

788

IMPELLER **2694461**

U.S. GALLONS PER MINUTE

CURVE **3132099**

1760 RPM

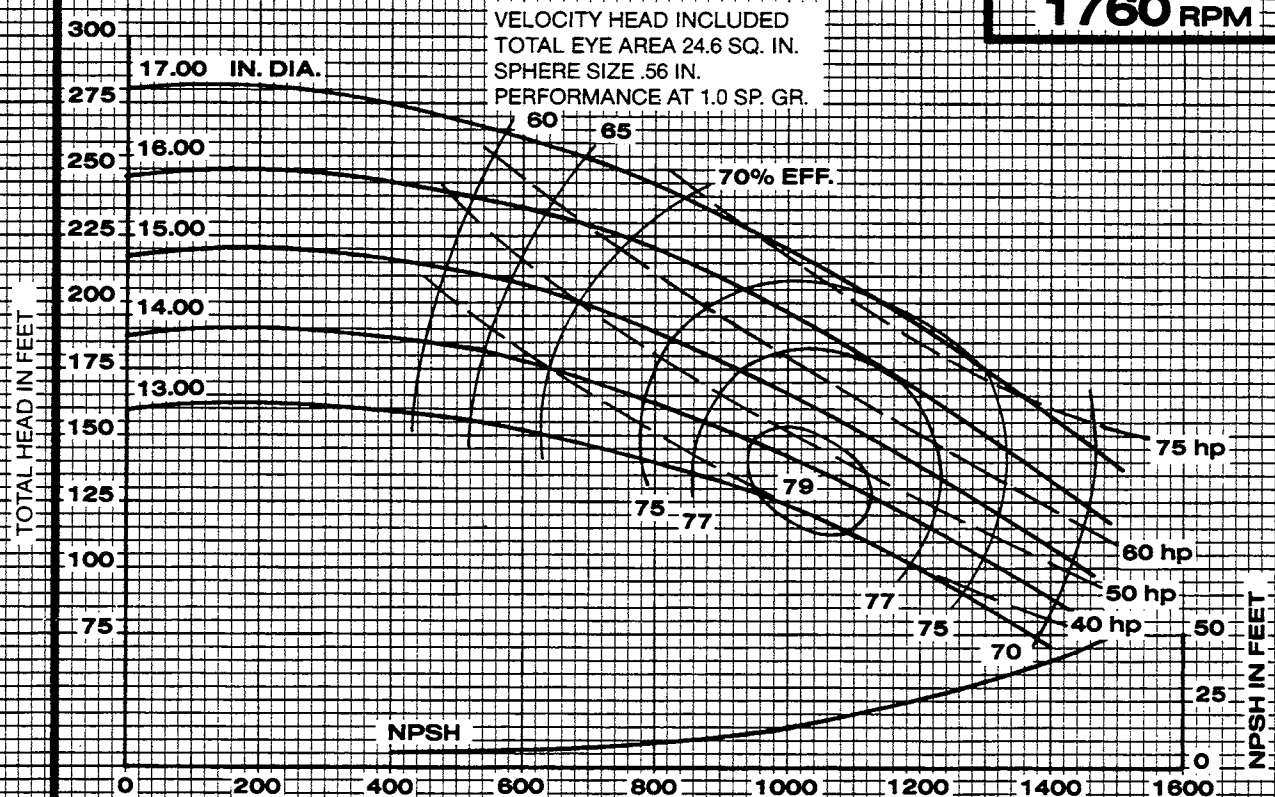

788

IMPELLER **2694461**

U.S. GALLONS PER MINUTE

CURVE **3132097**



Peerless Pump Company
Indianapolis, IN 46207-7026

HORIZONTAL SPLIT CASE PUMPS
Type 6AE16N Size 6x8x16.75

SECTION 1240

1150 RPM

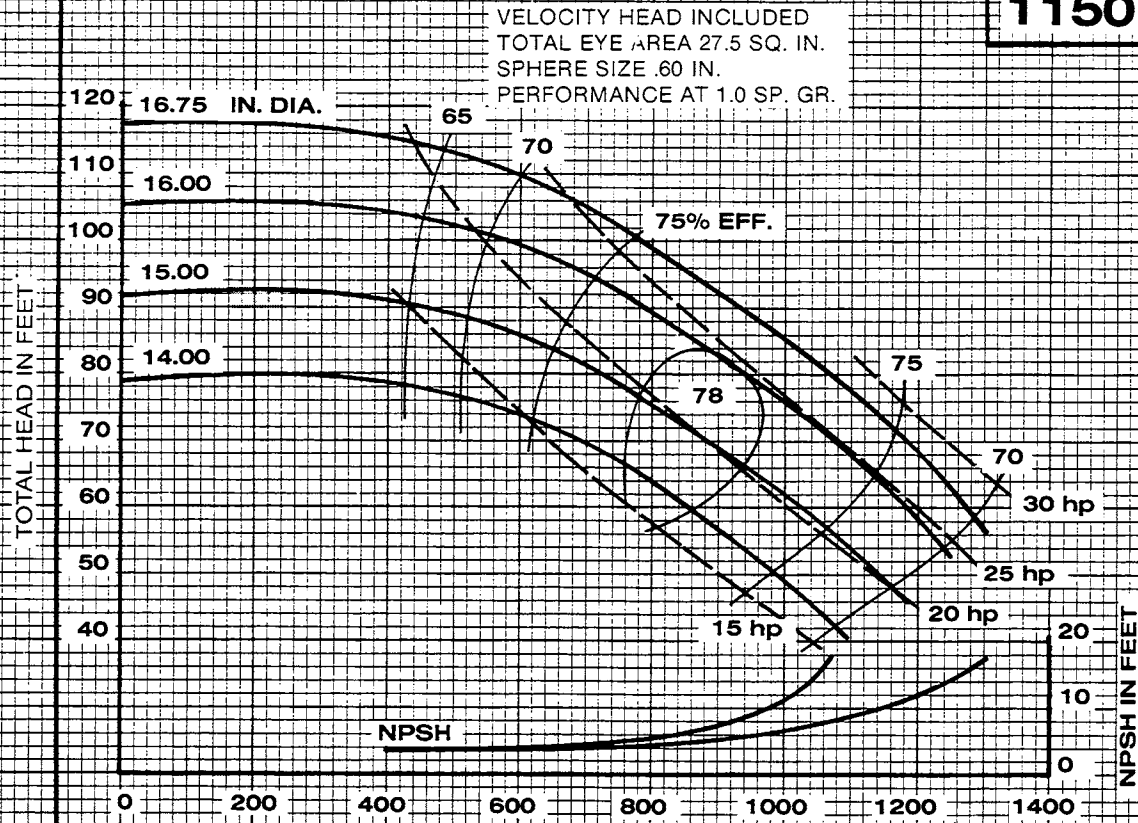

IMPELLER 2692931

U.S. GALLONS PER MINUTE

CURVE 3132089

1760 RPM

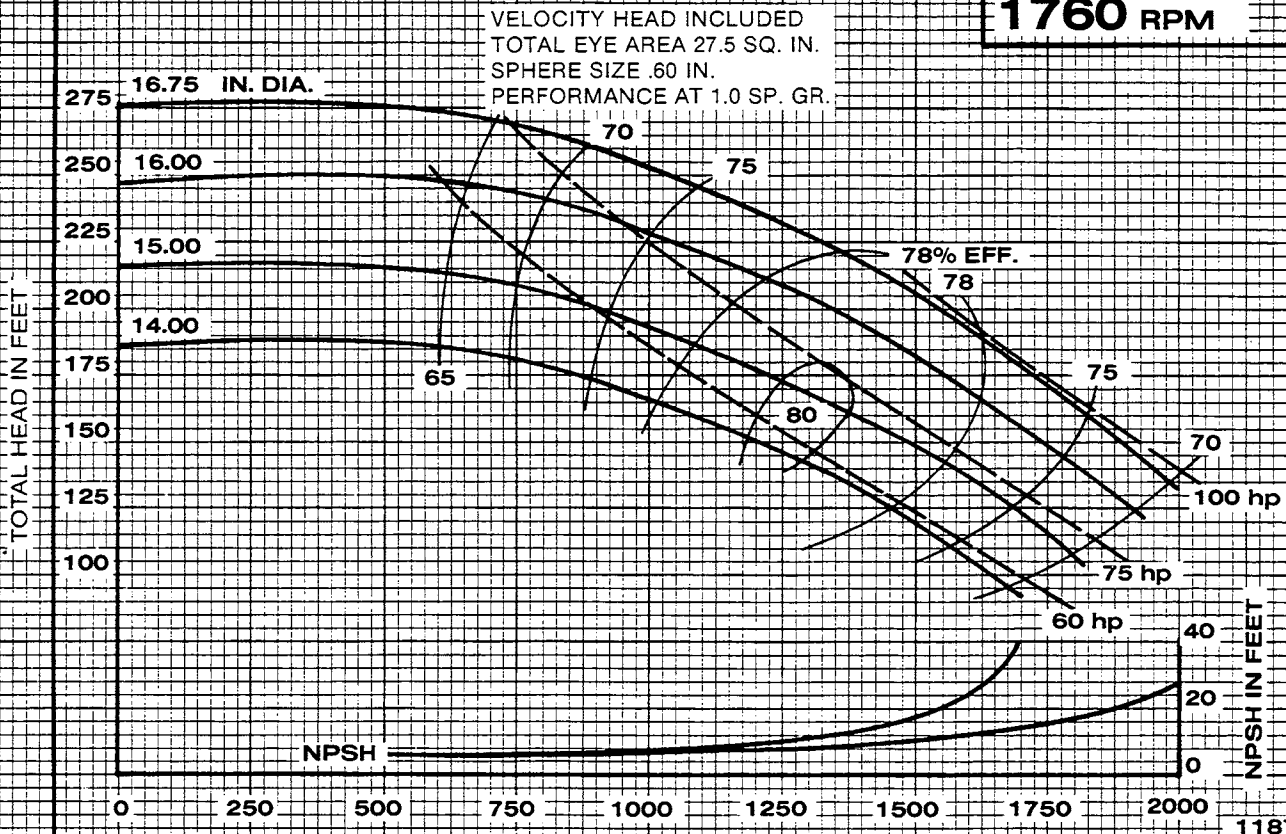

IMPELLER 2692931

U.S. GALLONS PER MINUTE

CURVE 3132087



Peerless Pump Company
Indianapolis, IN 46207-7026

HORIZONTAL SPLIT CASE PUMPS
Type 6AE18 Size 6 x 8 x 17.50

SECTION 1240

1160 RPM

VELOCITY HEAD INCLUDED
TOTAL EYE AREA 39.0 SQ. IN.
SPHERE SIZE .80 IN.
PERFORMANCE AT 1.0 SP. GR.

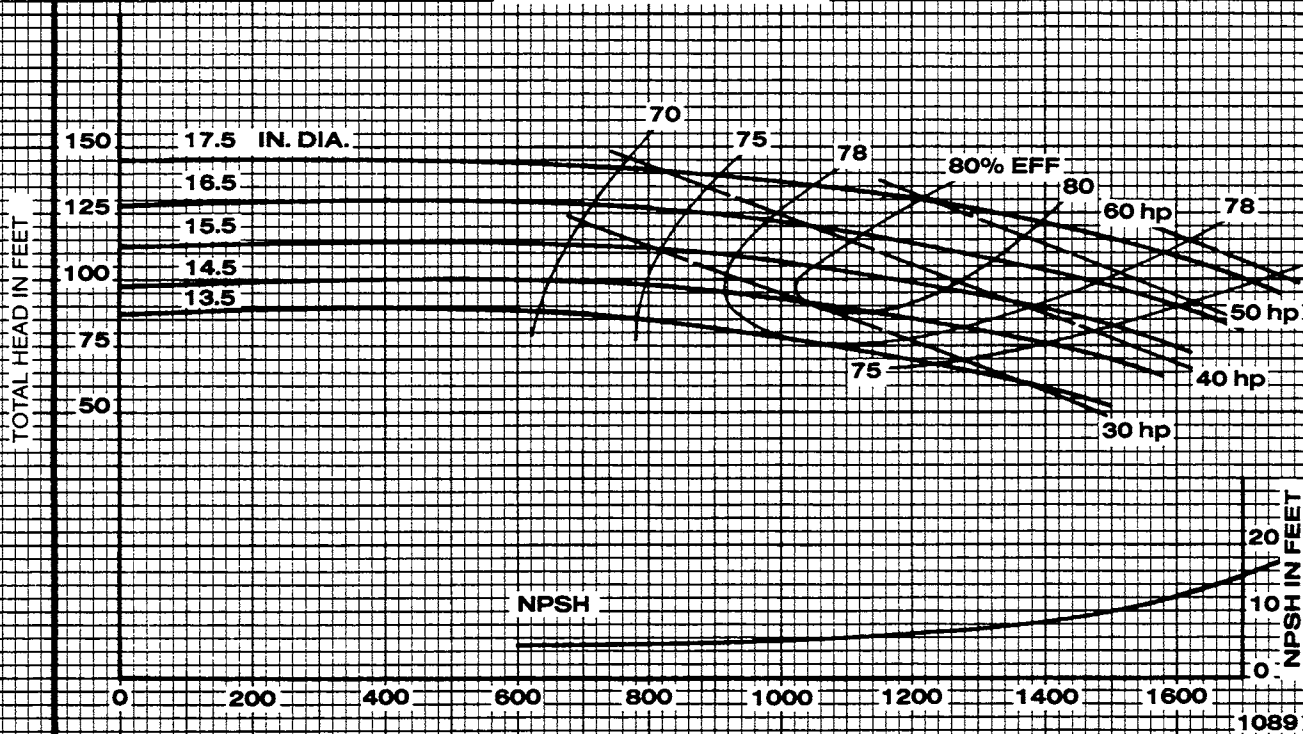

IMPELLER 2693457

U.S. GALLONS PER MINUTE

CURVE 3132119

1765 RPM

VELOCITY HEAD INCLUDED
TOTAL EYE AREA 39.0 SQ. IN.
SPHERE SIZE .80 IN.
PERFORMANCE AT 1.0 SP. GR.

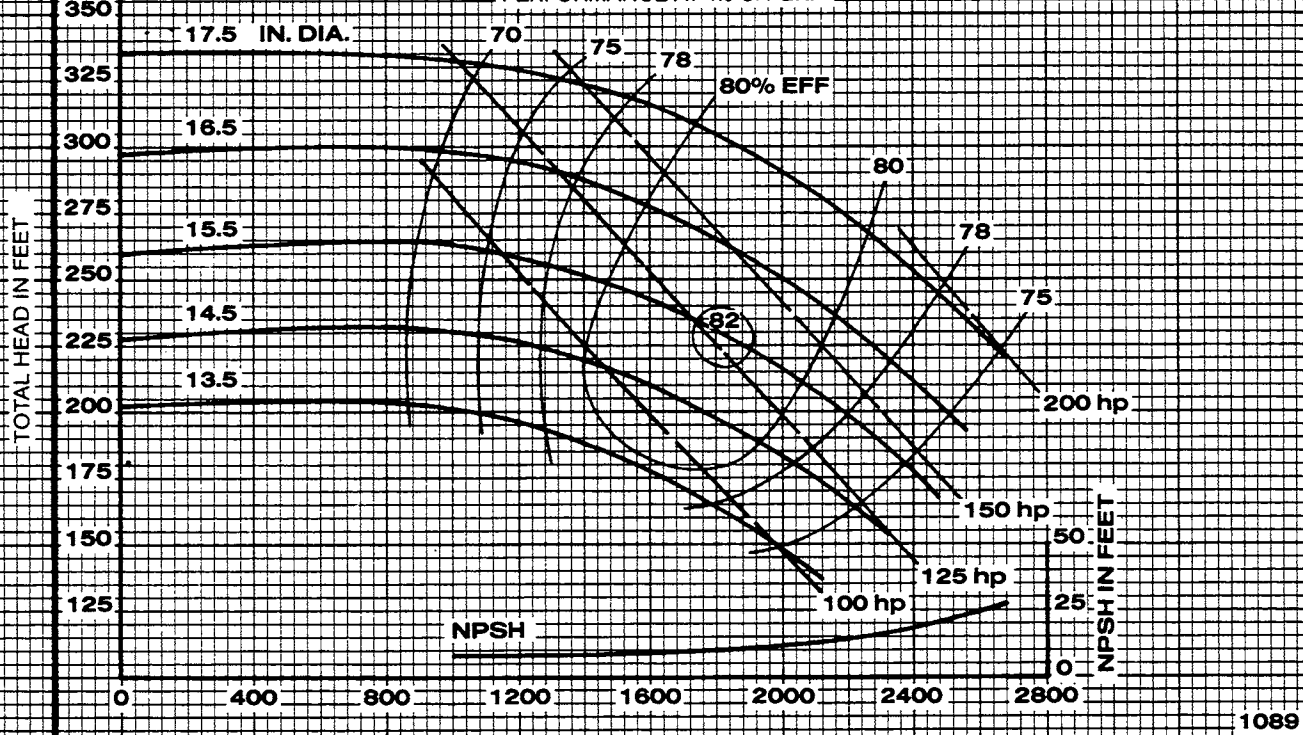

IMPELLER 2693457

U.S. GALLONS PER MINUTE

CURVE 3132117



Peerless Pump Company
Indianapolis, IN 46207-7026

HORIZONTAL SPLIT CASE PUMPS
Type 8AE12 Size 8x8x12.00

SECTION 1240

1150 RPM

VELOCITY HEAD INCLUDED
TOTAL EYE AREA 44.8 SQ. IN.
SPHERE SIZE 1.15 IN.
PERFORMANCE AT 1.0 SP. GR.

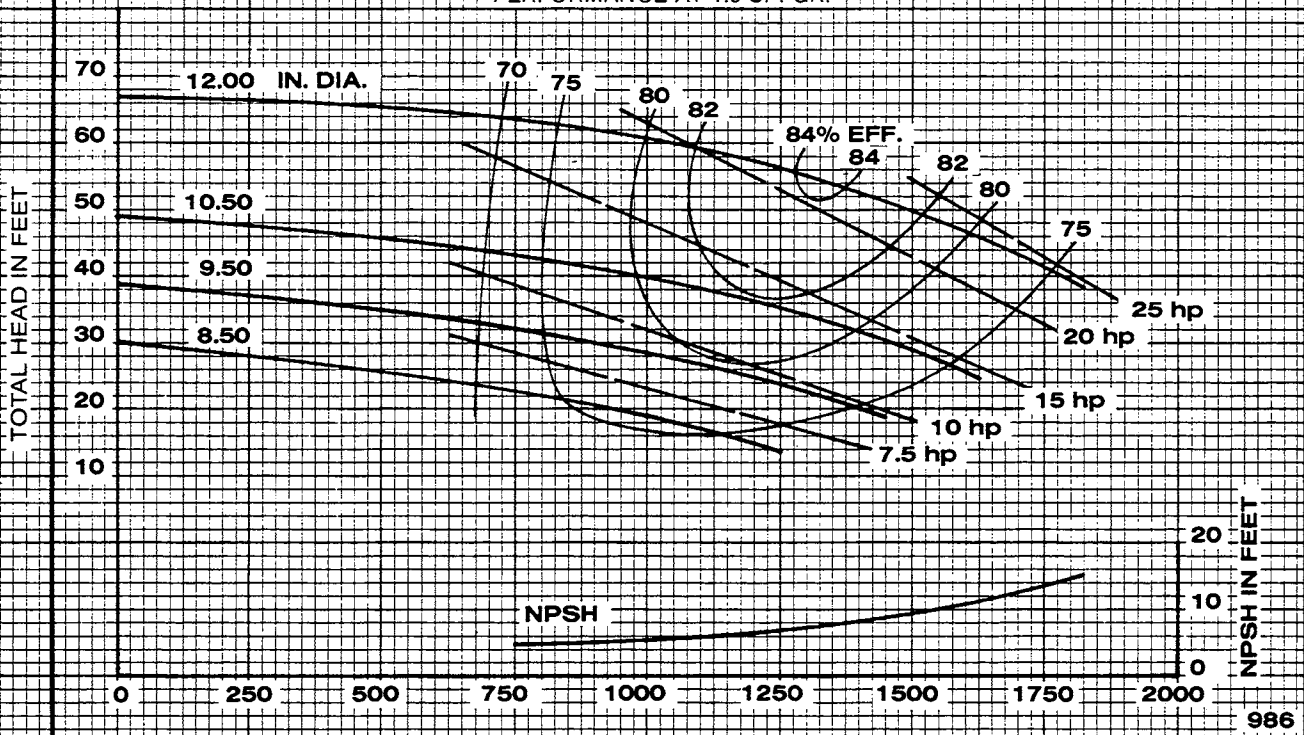

IMPELLER 2692806

U.S. GALLONS PER MINUTE

CURVE 3132019

1750 RPM

VELOCITY HEAD INCLUDED
TOTAL EYE AREA 44.8 SQ. IN.
SPHERE SIZE 1.15 IN.
PERFORMANCE AT 1.0 SP. GR.

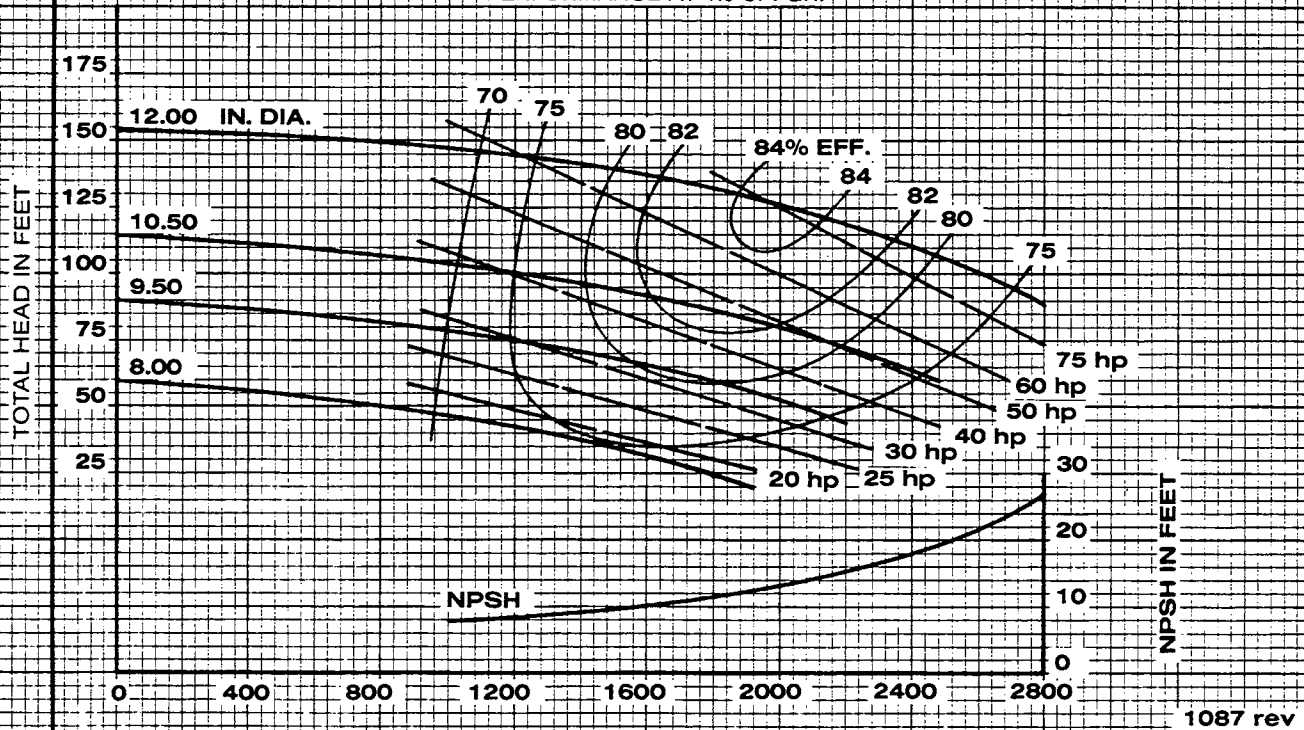

IMPELLER 2692806

U.S. GALLONS PER MINUTE

CURVE 3132017



Peerless Pump Company
Indianapolis, IN 46207-7026

HORIZONTAL SPLIT CASE PUMPS
Type 8AE13 Size 8x10x13.00

SECTION 1240

1150 RPM

VELOCITY HEAD INCLUDED
TOTAL EYE AREA 63.5 SQ. IN.
SPHERE SIZE .85 IN.
PERFORMANCE AT 1.0 SP. GR.

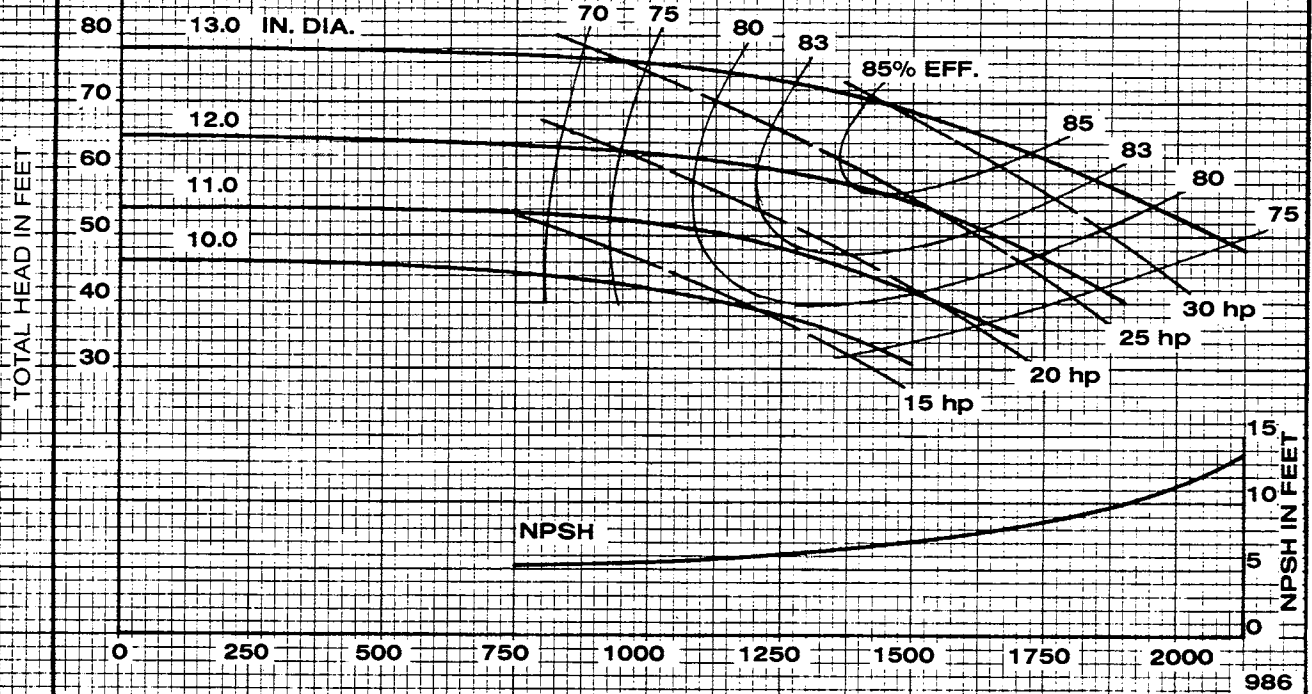

IMPELLER 2693445

U.S. GALLONS PER MINUTE

CURVE 3132025

1750 RPM

VELOCITY HEAD INCLUDED
TOTAL EYE AREA 63.5 SQ. IN.
SPHERE SIZE .85 IN.
PERFORMANCE AT 1.0 SP. GR.

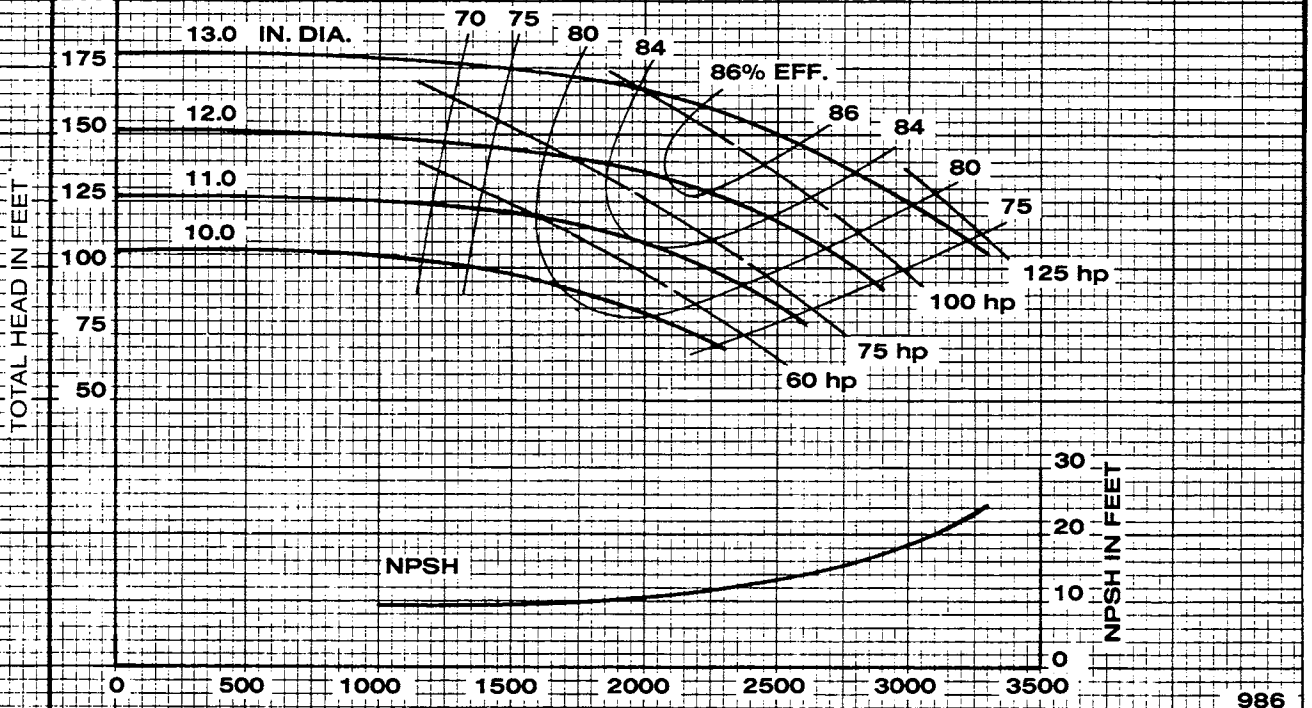

IMPELLER 2693445

U.S. GALLONS PER MINUTE

CURVE 3132023



Peerless Pump Company
Indianapolis, IN 46207-7026

HORIZONTAL SPLIT CASE PUMPS
Type 8AE15 Size 8 x 10 x 15.50

SECTION 1240

1160 RPM

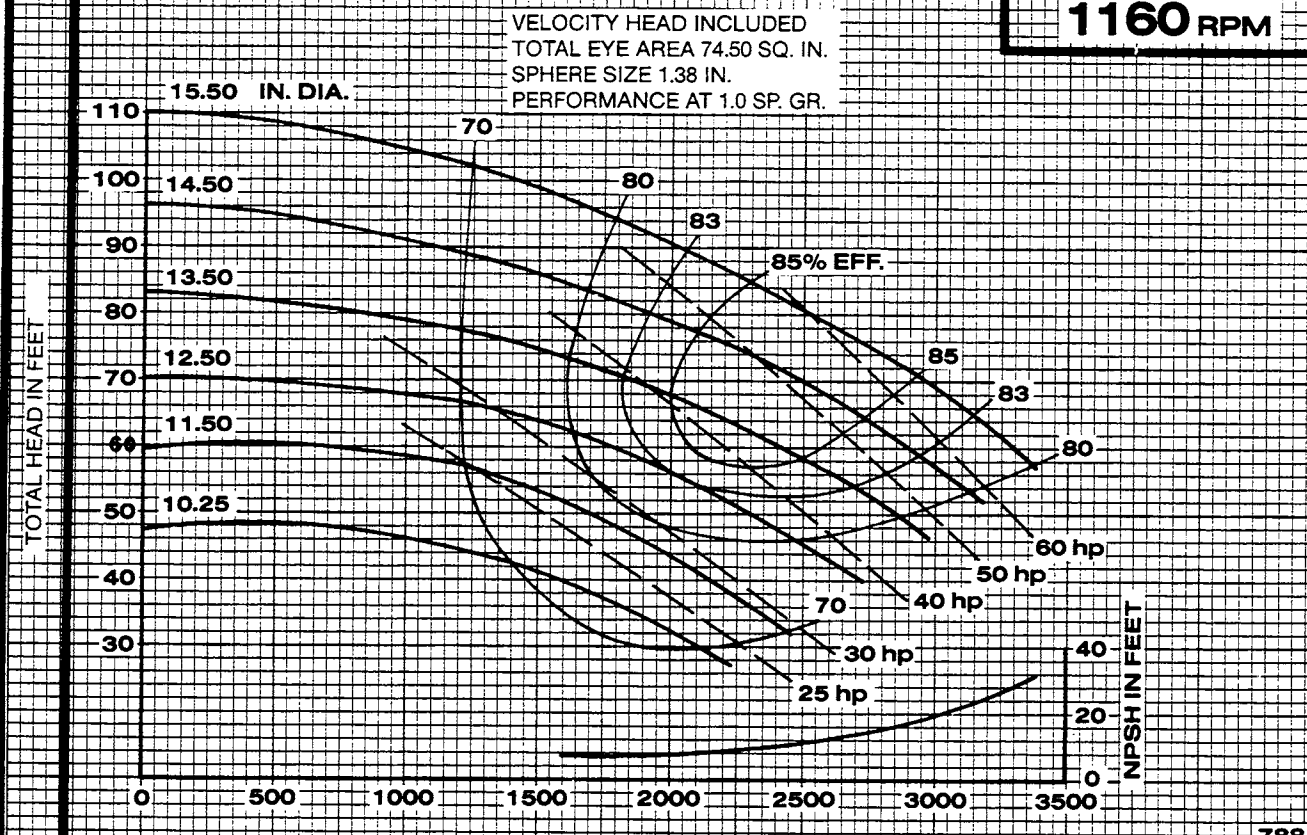

788

IMPELLER 2692769

U.S. GALLONS PER MINUTE

CURVE 3112028R

1765 RPM

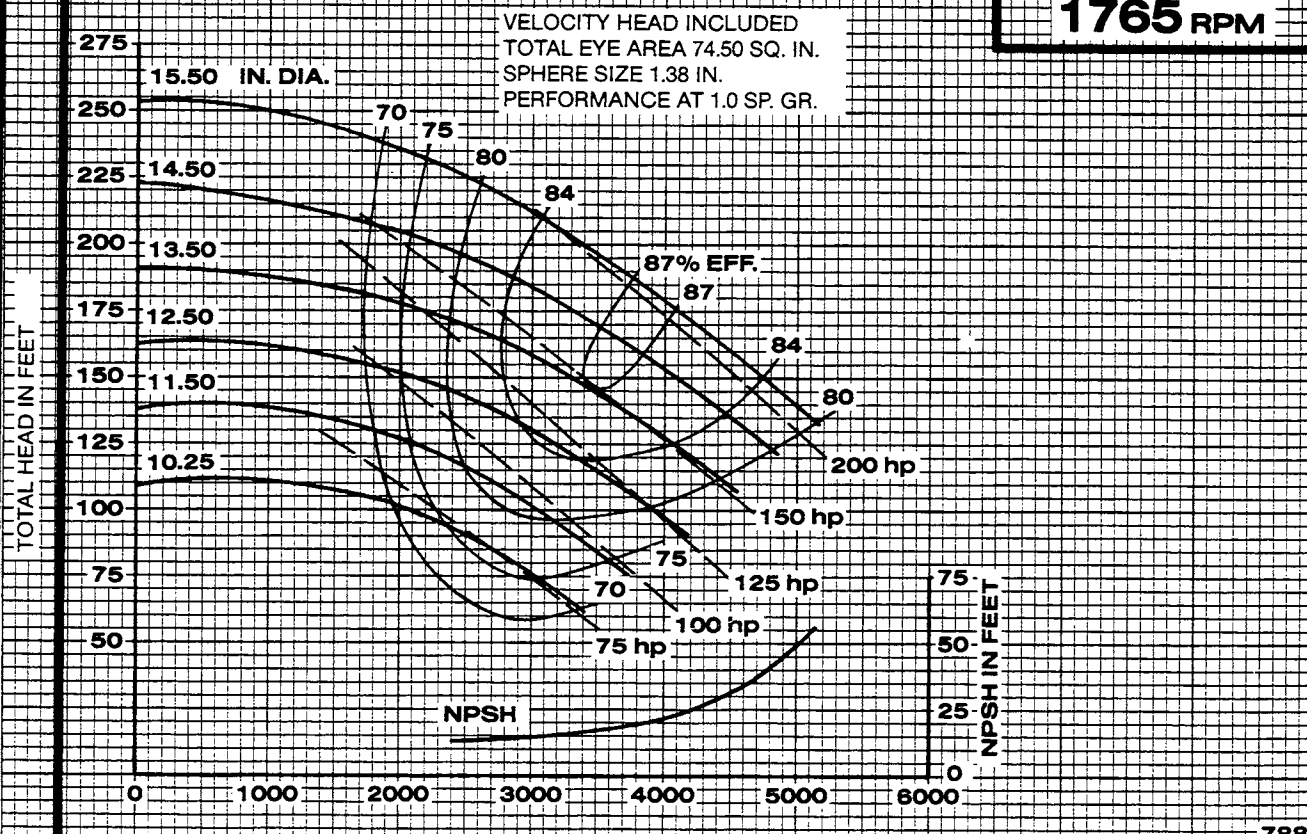

788

IMPELLER 2692769

U.S. GALLONS PER MINUTE

CURVE 3112026R



Peerless Pump Company
Indianapolis, IN 46207-7026

HORIZONTAL SPLIT CASE PUMPS
Type 8AE15G Size 8 x 10 x 15.25

SECTION 1240

1160 RPM

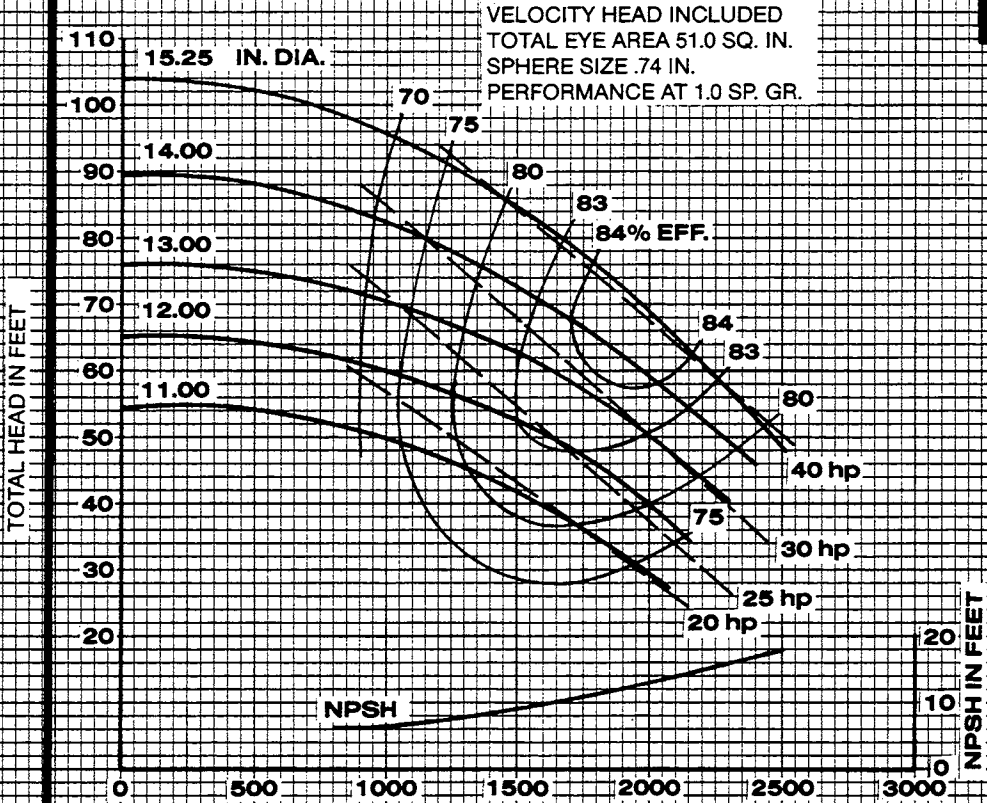

788

IMPELLER 2694320

U.S. GALLONS PER MINUTE

CURVE 3132083R

1765 RPM

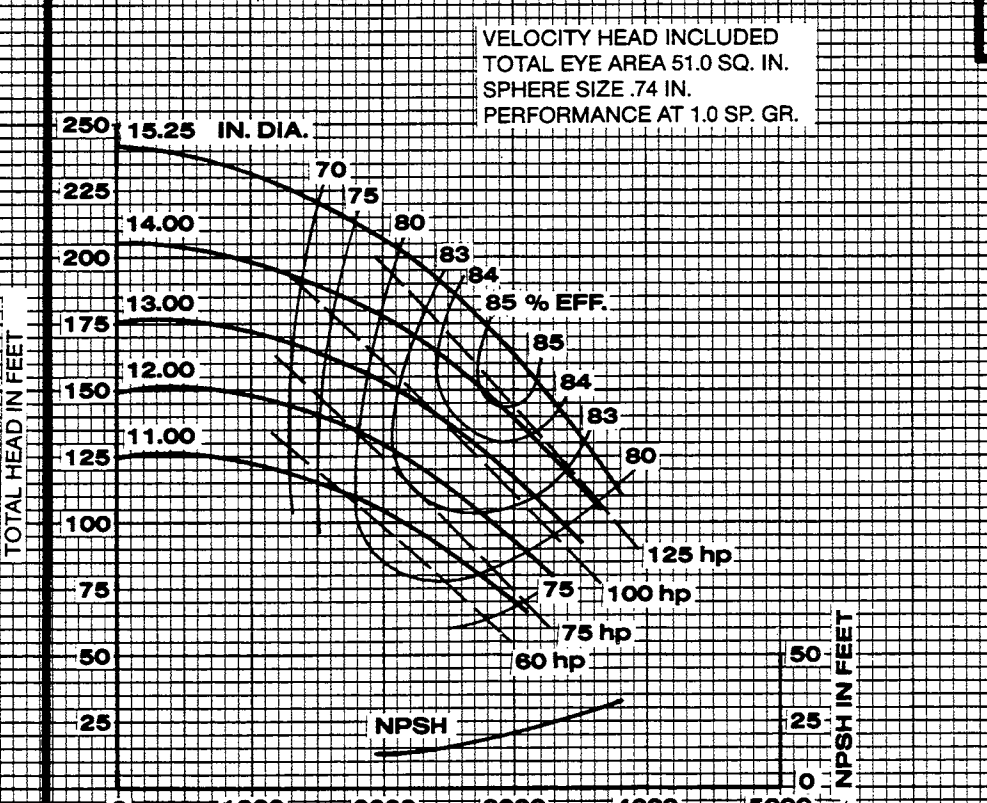

788

IMPELLER 2694320

U.S. GALLONS PER MINUTE

CURVE 3132081R



Peerless Pump Company
Indianapolis, IN 46207-7026

HORIZONTAL SPLIT CASE PUMPS

Type 8AE17A

Size 8 x 10 x 17

SECTION 1240

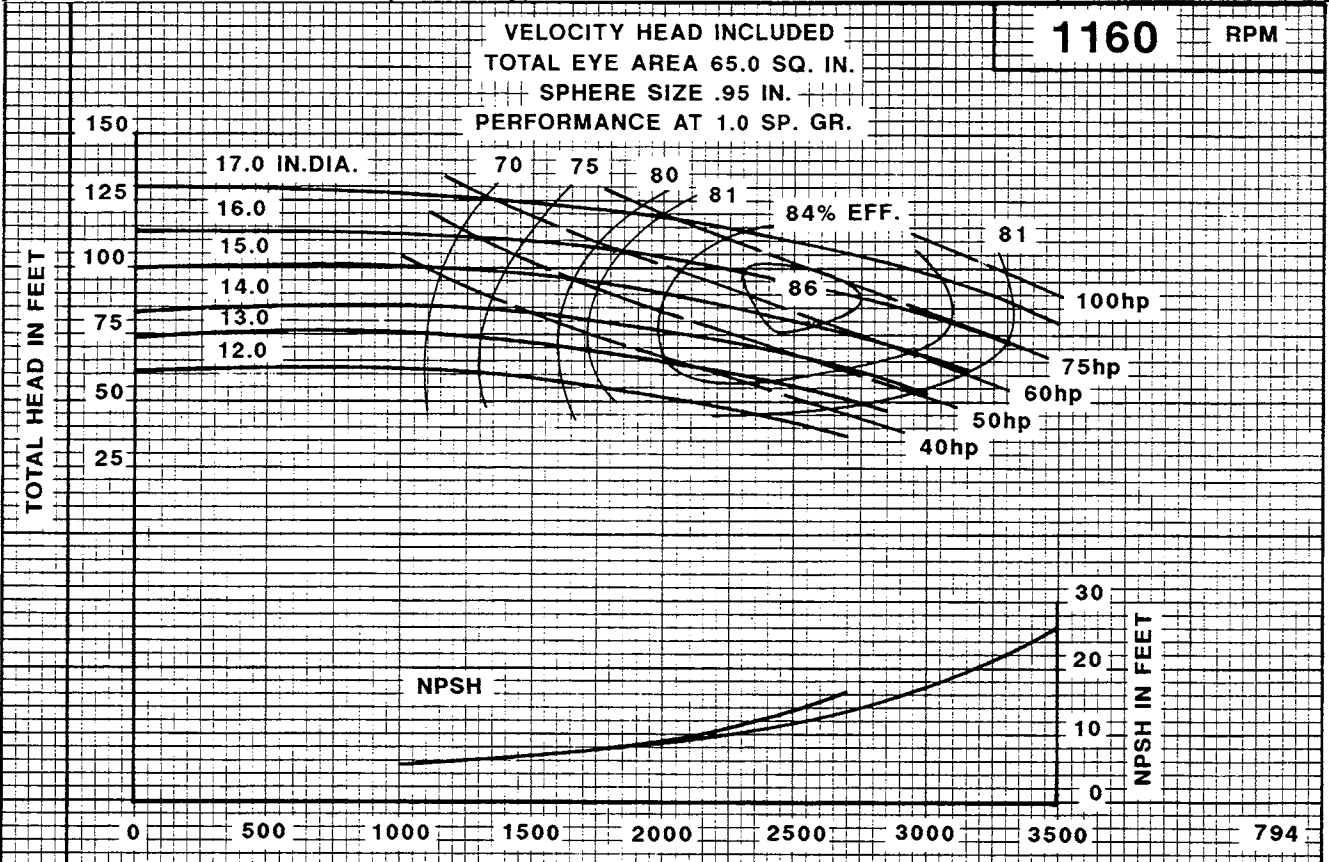

IMPELLER 2693259

U.S. GALLONS PER MINUTE

CURVE 3132141

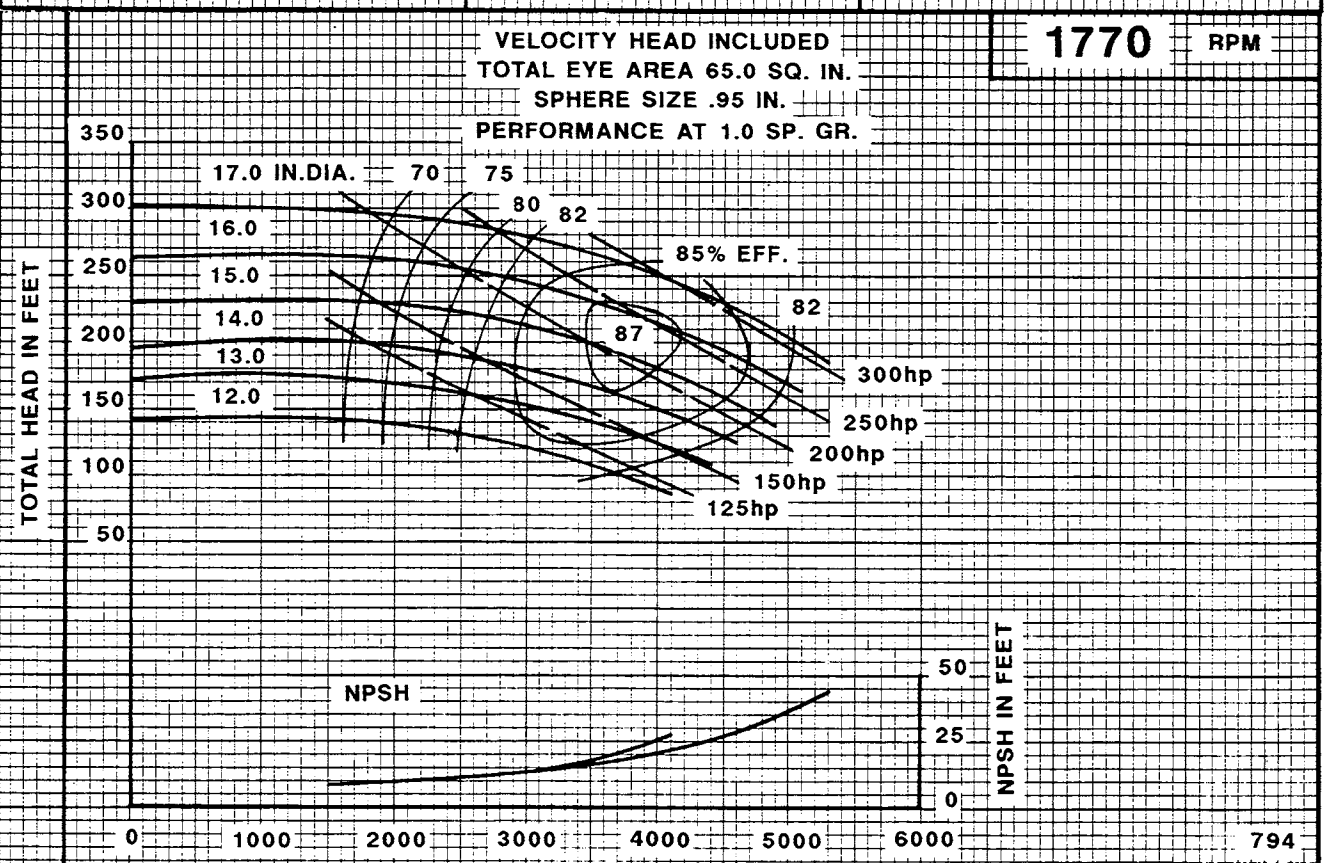

IMPELLER 2693259

U.S. GALLONS PER MINUTE

CURVE 3132139



Peerless Pump Company
Indianapolis, IN 46207-7026

HORIZONTAL SPLIT CASE PUMPS
Type 8AE17Q Size 8 x 10 x 17

SECTION 1240

VELOCITY HEAD INCLUDED
TOTAL EYE AREA 55.8 SQ. IN.
SPHERE SIZE .94 IN.
PERFORMANCE AT 1.0 SP. GR.

1160 RPM

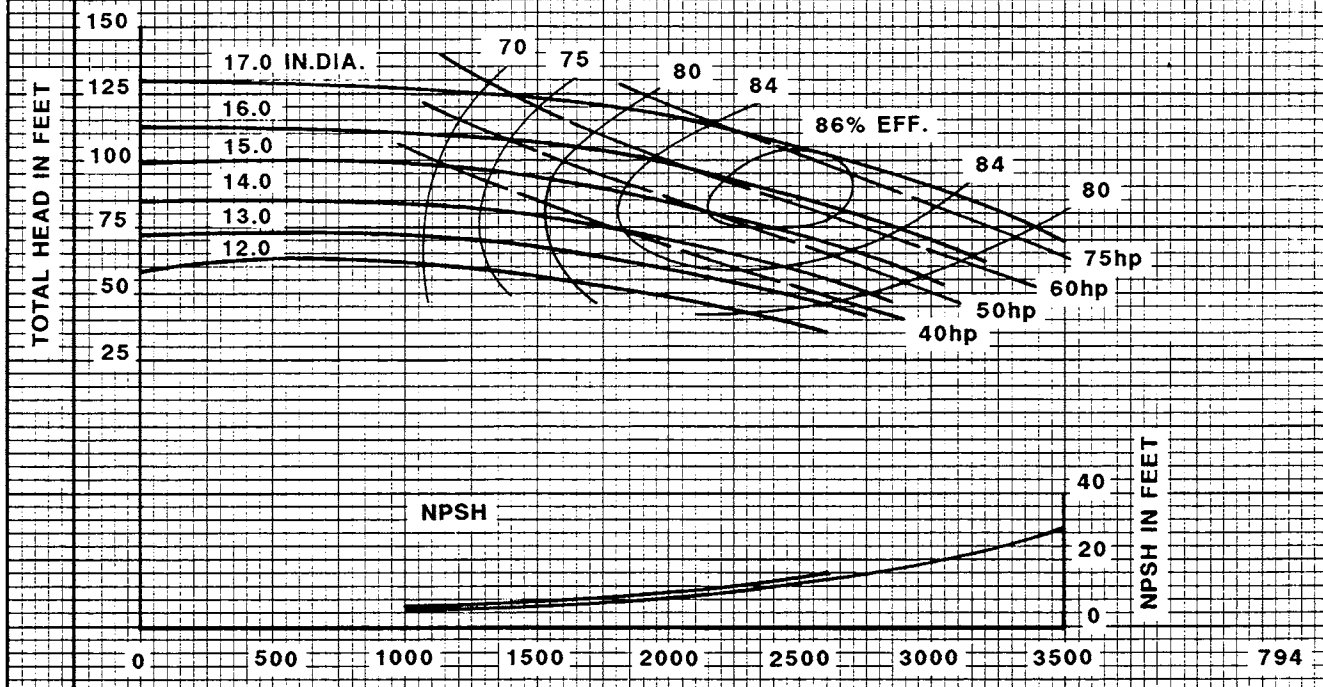

IMPELLER 2693257

U.S. GALLONS PER MINUTE

CURVE 3132144

VELOCITY HEAD INCLUDED
TOTAL EYE AREA 55.8 SQ. IN.
SPHERE SIZE .94 IN.
PERFORMANCE AT 1.0 SP. GR.

1770 RPM

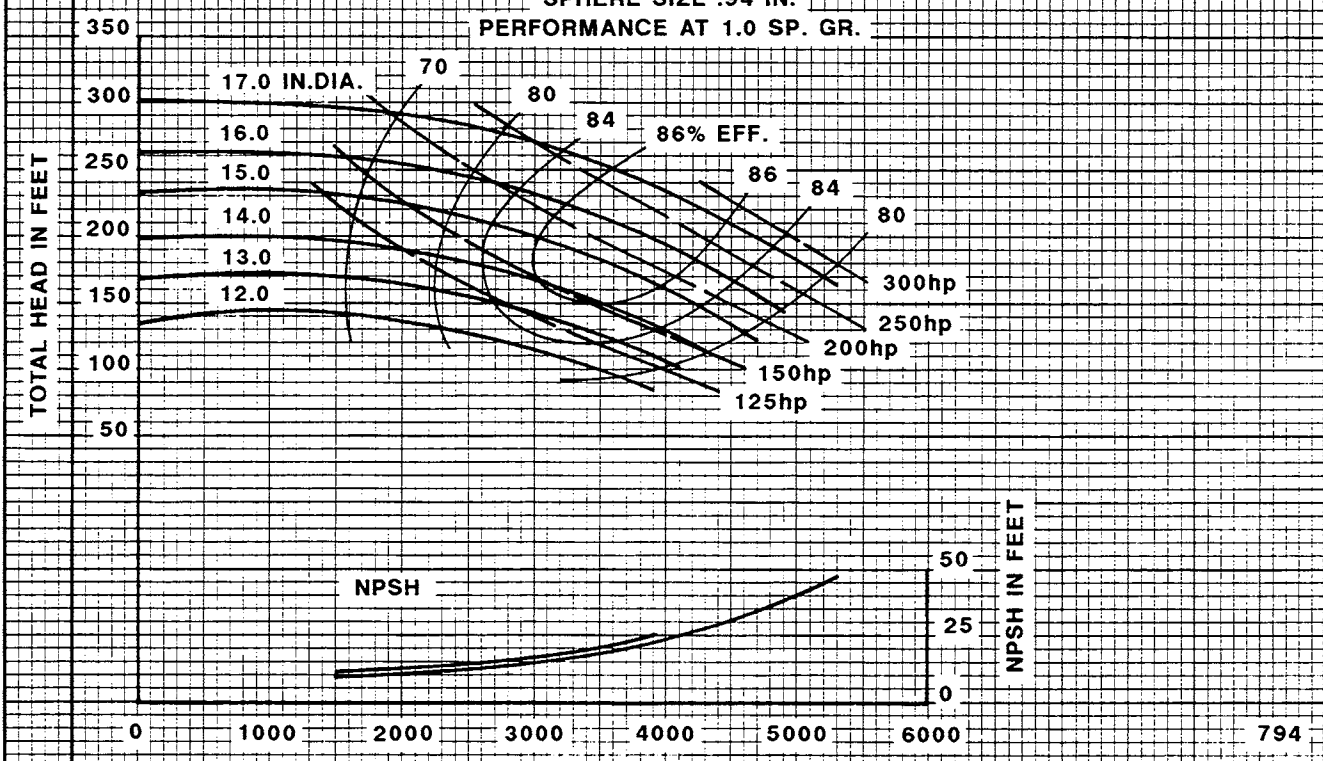

IMPELLER 2693257

U.S. GALLONS PER MINUTE

CURVE 3132142



Peerless Pump Company
Indianapolis, IN 46207-7026

HORIZONTAL SPLIT CASE PUMPS
Type 8AE17W Size 8 x 10 x 17

SECTION 1240

1770 RPM

VELOCITY HEAD INCLUDED
TOTAL EYE AREA 48.4 SQ.IN.
SPHERE SIZE .875 IN.
PERFORMANCE AT 1.0 SP.GR.

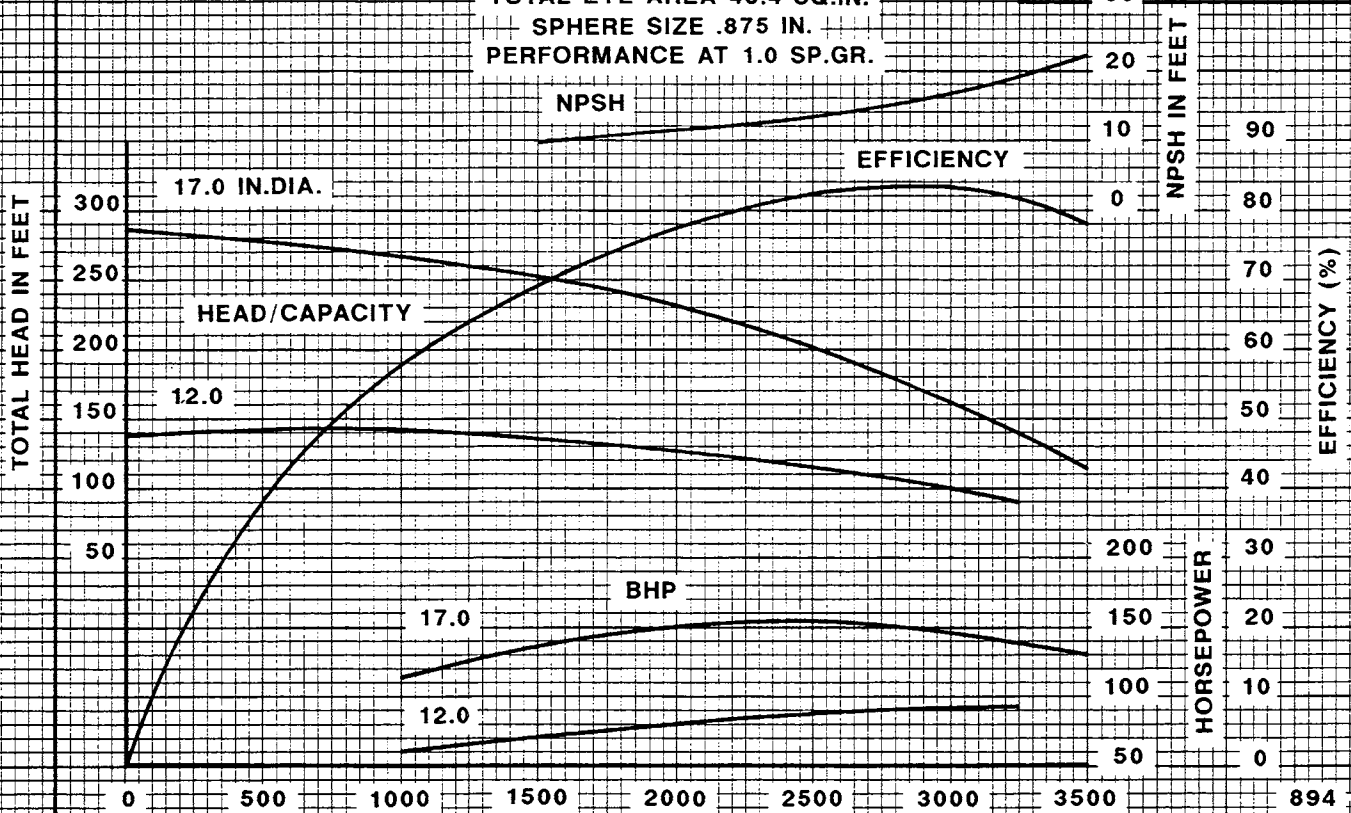

IMPELLER 2693258

U.S. GALLONS PER MINUTE

CURVE 3132145

894



Peerless Pump Company
Indianapolis, IN 46207-7026

HORIZONTAL SPLIT CASE PUMPS
Type 8AE20 Size 8x10x19.00

SECTION 1240

1160 RPM

VELOCITY HEAD INCLUDED
TOTAL EYE AREA 48.5 SQ. IN.
SPHERE SIZE .75 IN.
PERFORMANCE AT 1.0 SP. GR.

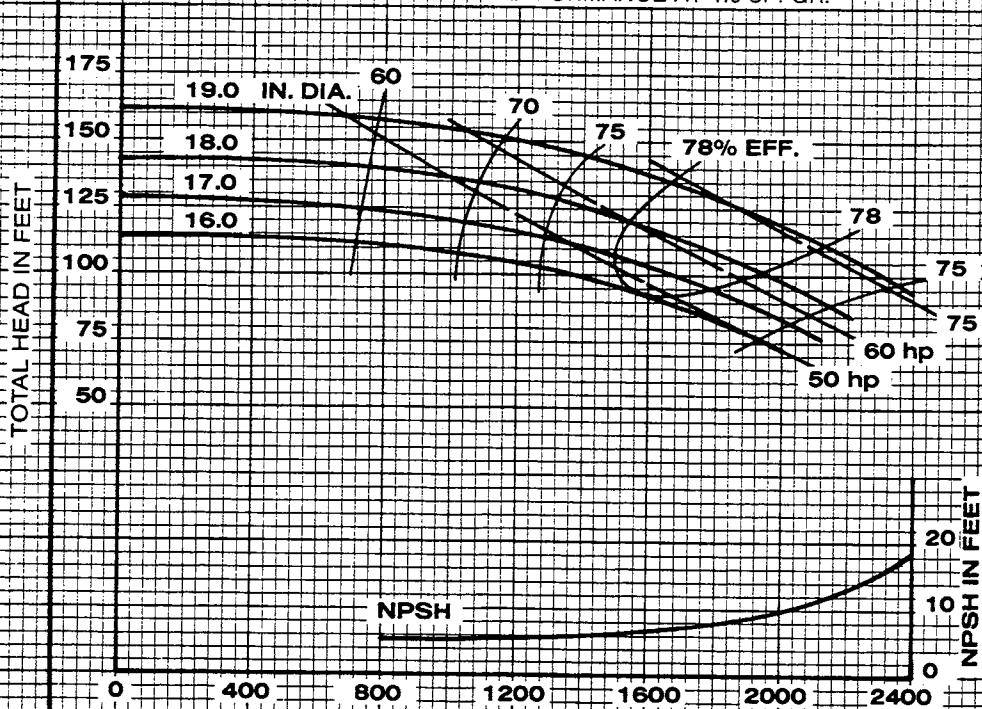

987

IMPELLER 2693333

U.S. GALLONS PER MINUTE

CURVE 3132071

1770 RPM

VELOCITY HEAD INCLUDED
TOTAL EYE AREA 48.5 SQ. IN.
SPHERE SIZE .75 IN.
PERFORMANCE AT 1.0 SP. GR.

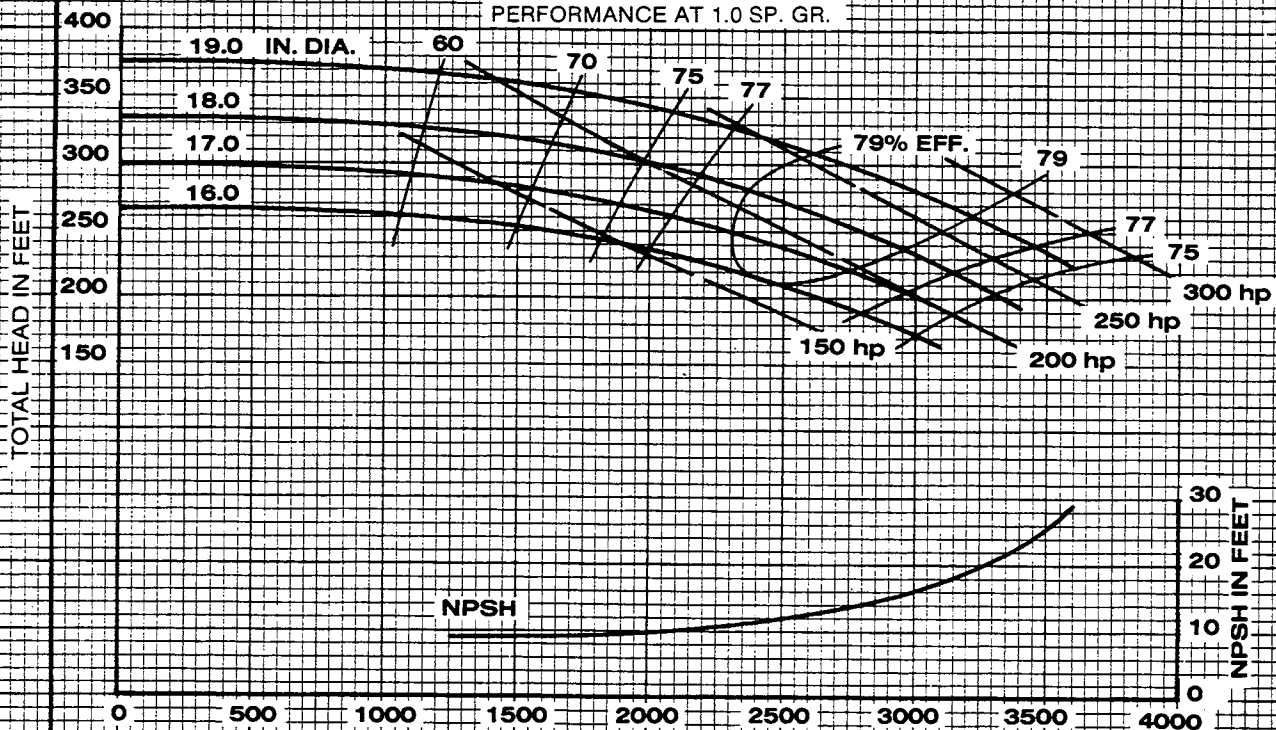

987

IMPELLER 2693333

U.S. GALLONS PER MINUTE

CURVE 3132069

1160 RPM

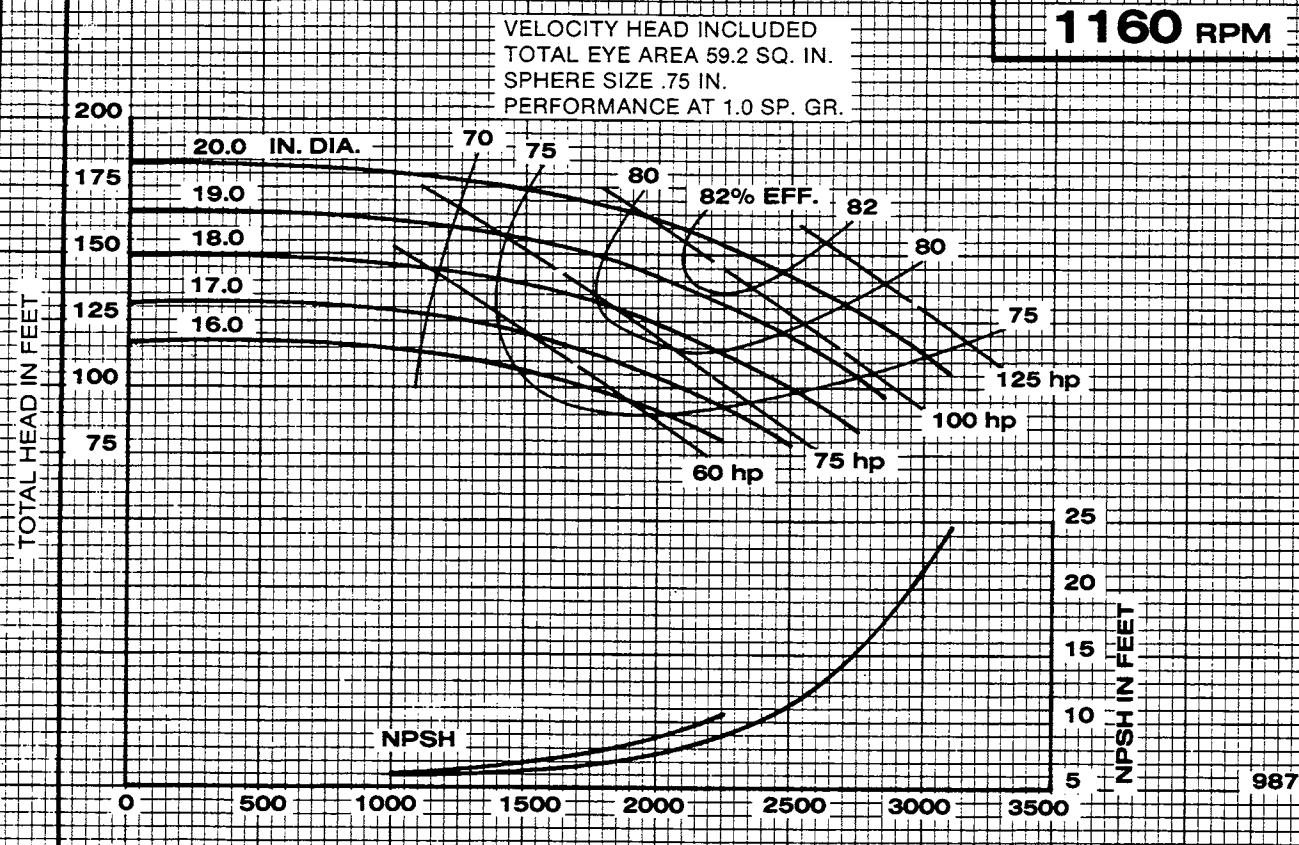

IMPELLER **2693332**

U.S. GALLONS PER MINUTE

CURVE **3132077**

1770 RPM

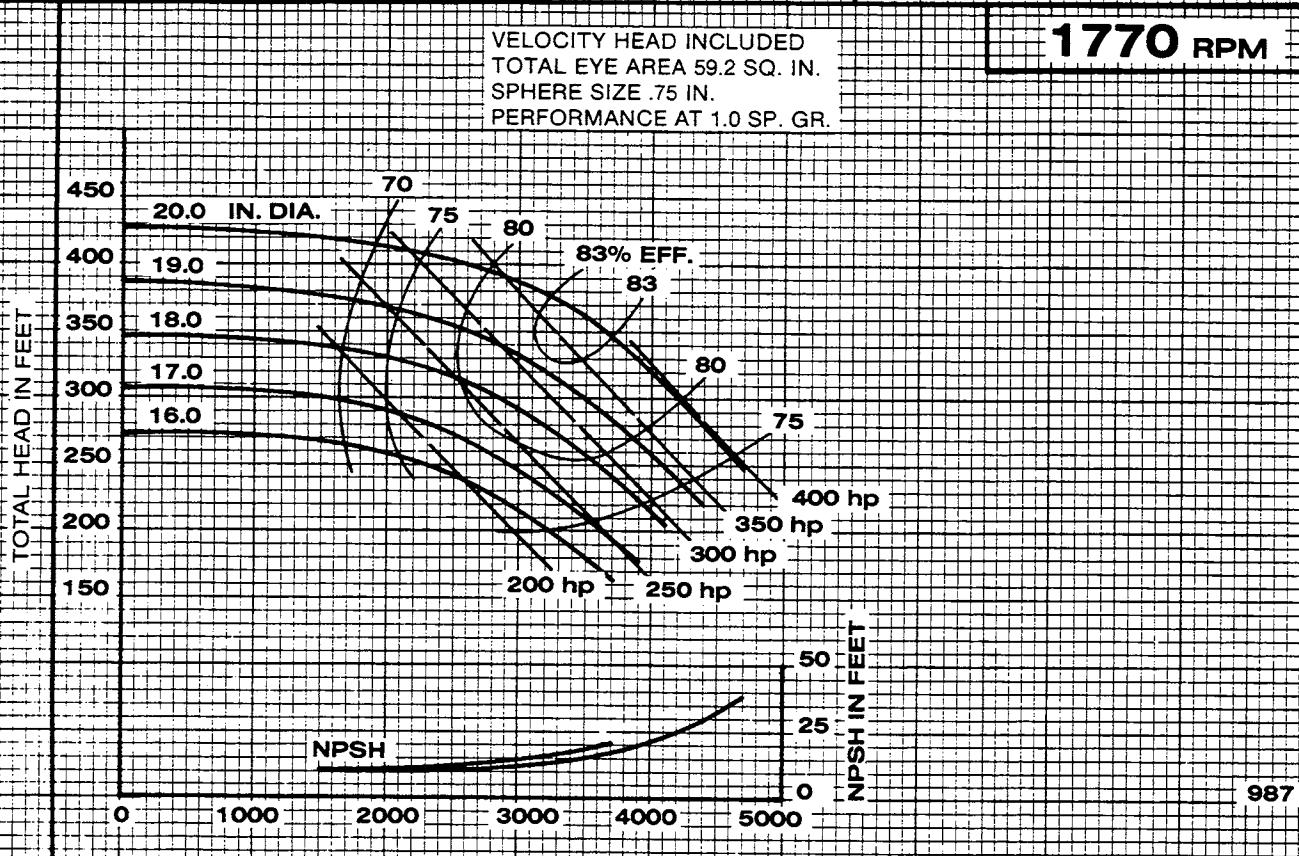

IMPELLER **2693332**

U.S. GALLONS PER MINUTE

CURVE **3132075**



Peerless Pump Company
Indianapolis, IN 46207-7026

HORIZONTAL SPLIT CASE PUMPS
Type 10AE12 Size 10 x 10 x 12.00

SECTION 1240

1150 RPM

VELOCITY HEAD INCLUDED
TOTAL EYE AREA 64.4 SQ. IN.
SPHERE SIZE .77 IN.
PERFORMANCE AT 1.0 SP. GR.

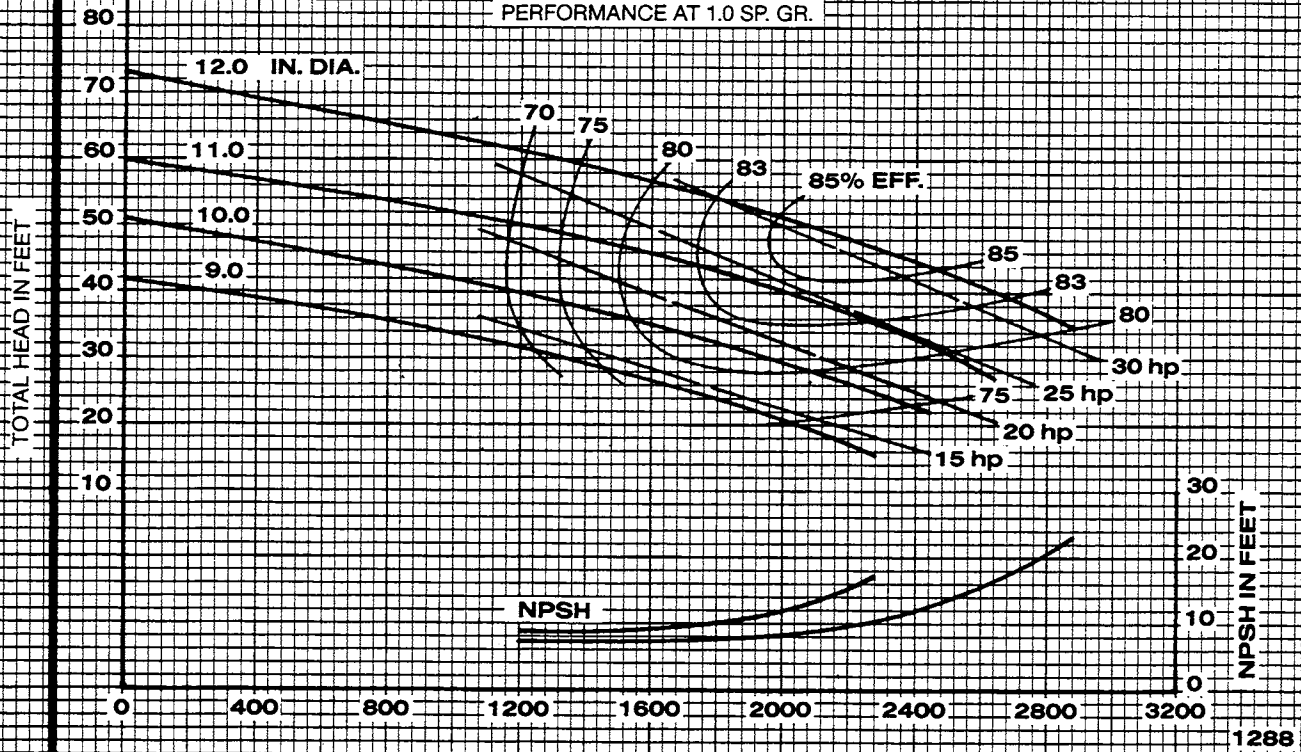

IMPELLER **2694126**

U.S. GALLONS PER MINUTE

CURVE **3132113**

1760 RPM

VELOCITY HEAD INCLUDED
TOTAL EYE AREA 64.4 SQ. IN.
SPHERE SIZE .77 IN.
PERFORMANCE AT 1.0 SP. GR.

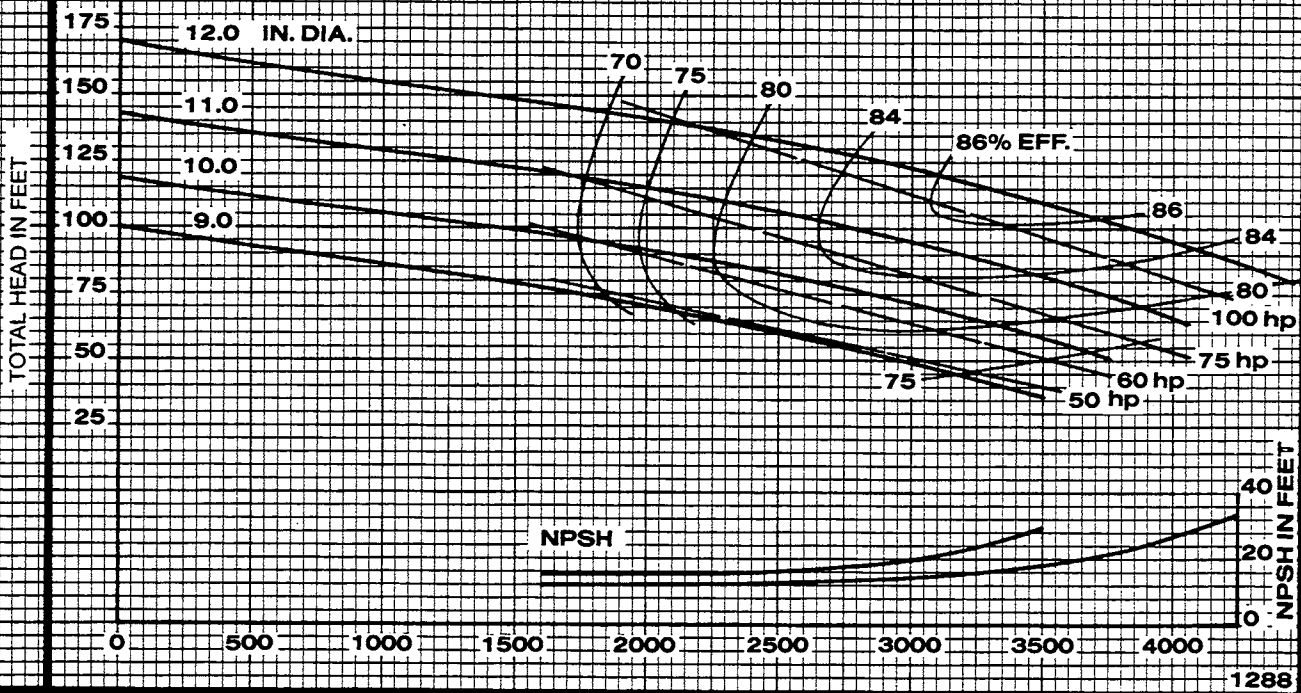

IMPELLER **2694126**

U.S. GALLONS PER MINUTE

CURVE **3132111**



Peerless Pump Company
Indianapolis, IN 46207-7026

HORIZONTAL SPLIT CASE PUMPS
Type 10AE14A Size 10 x 12 x 14

SECTION 1240

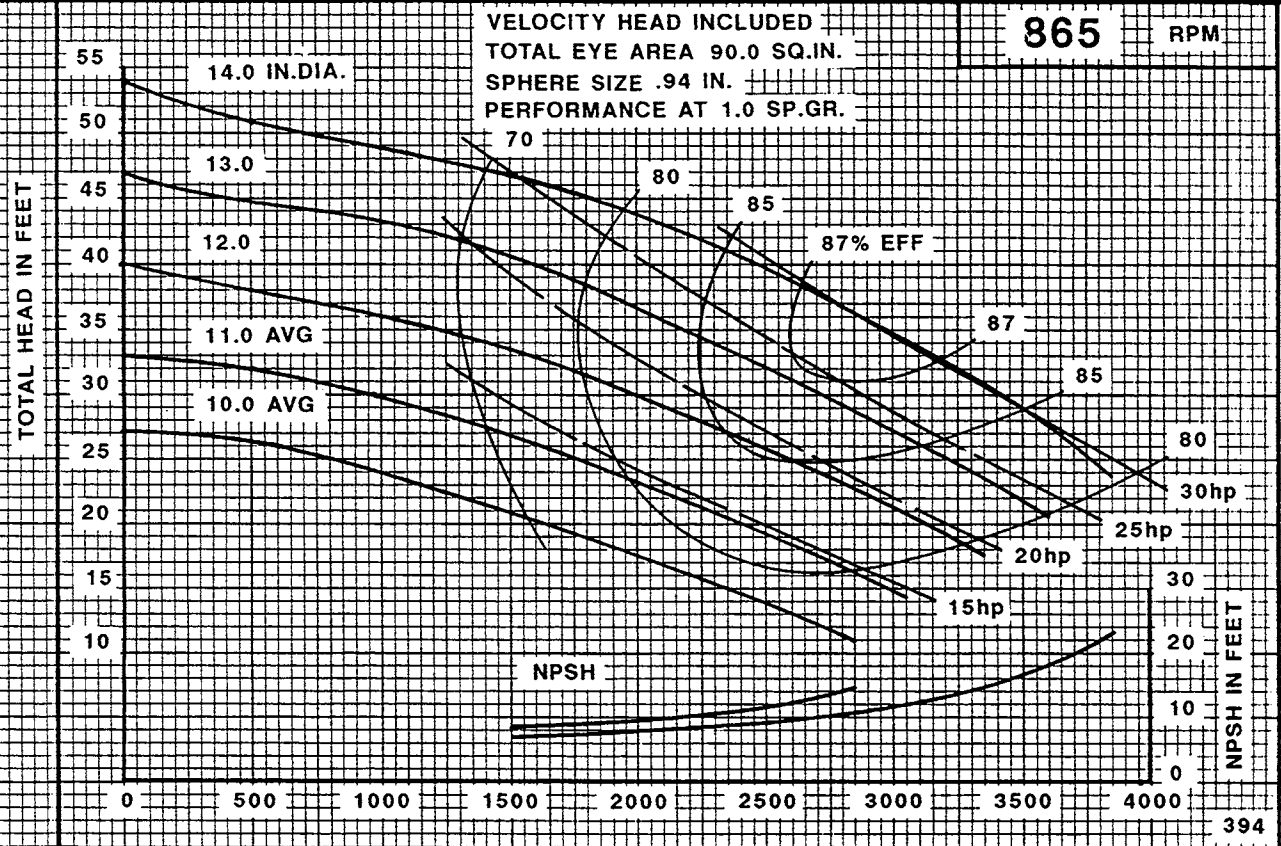

IMPELLER 2693193

U.S. GALLONS PER MINUTE

CURVE 3132138

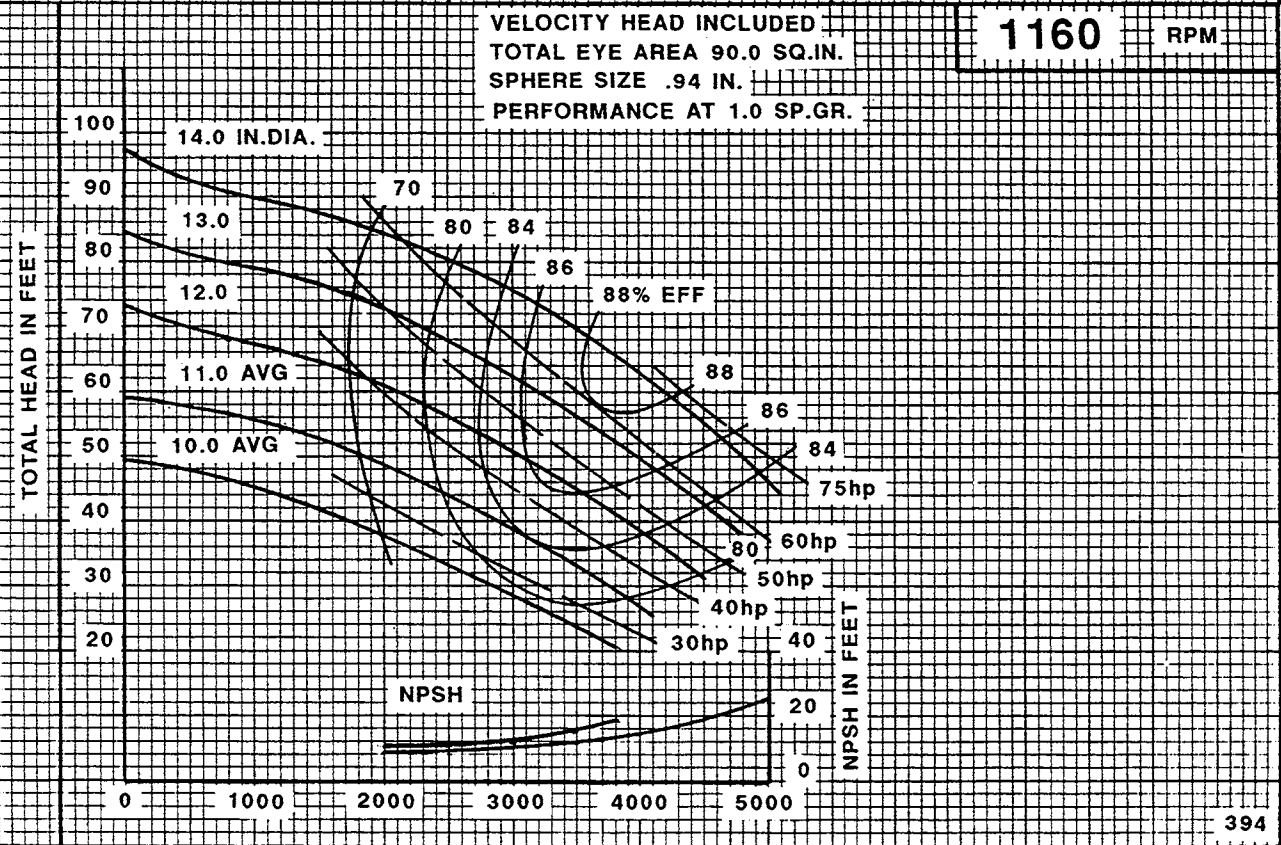

IMPELLER 2693193

U.S. GALLONS PER MINUTE

CURVE 3132137



Peerless Pump Company
Indianapolis, IN 46207-7026

HORIZONTAL SPLIT CASE PUMPS
Type 10AE14A Size 10 x 12 x 14

SECTION 1240

VELOCITY HEAD INCLUDED
TOTAL EYE AREA 90.0 SQ.IN.
SPHERE SIZE .94 IN.
PERFORMANCE AT 1.0 SP.GR.

1770 RPM

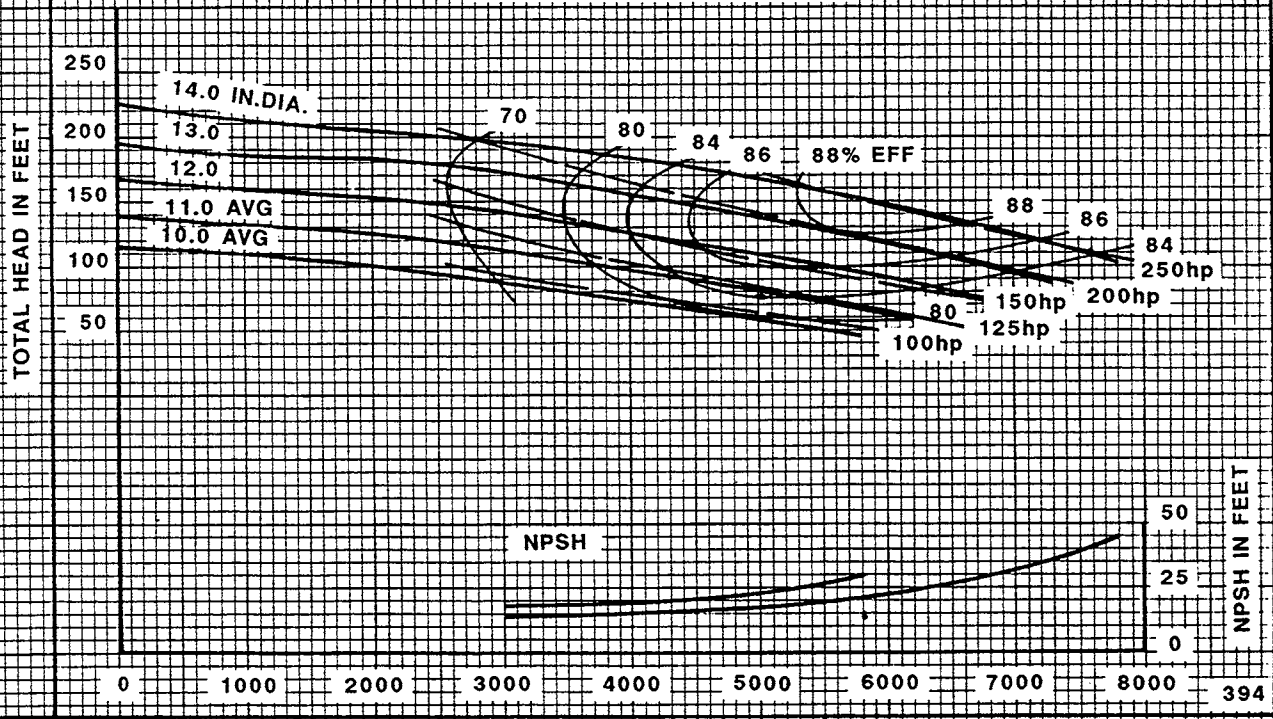

IMPELLER 2693193

U.S. GALLONS PER MINUTE

CURVE 3132135



Peerless Pump Company
Indianapolis, IN 46207-7026

HORIZONTAL SPLIT CASE PUMPS
Type 10AE14J Size 10 x 12 x 14

SECTION 1240

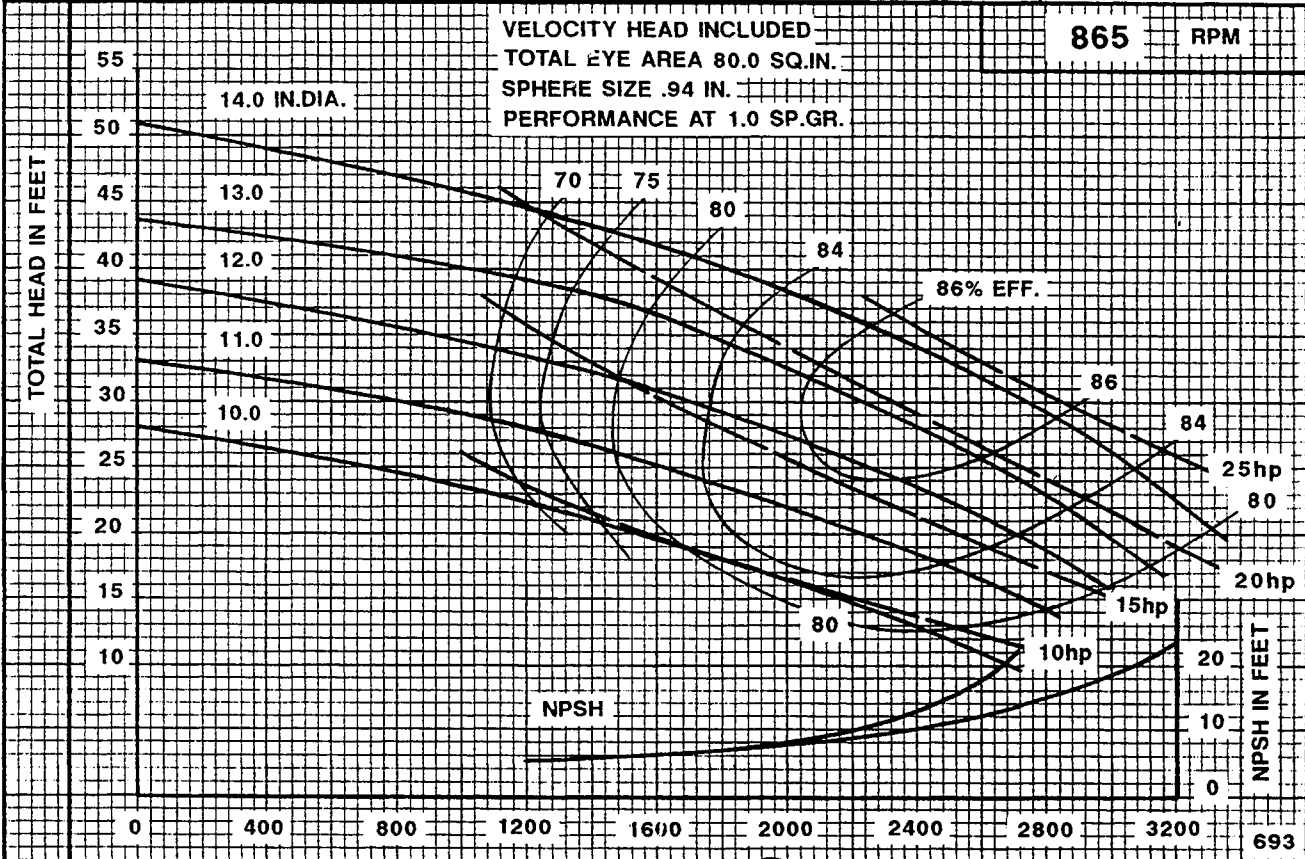

IMPELLER 2693192

U.S. GALLONS PER MINUTE

CURVE 3132134

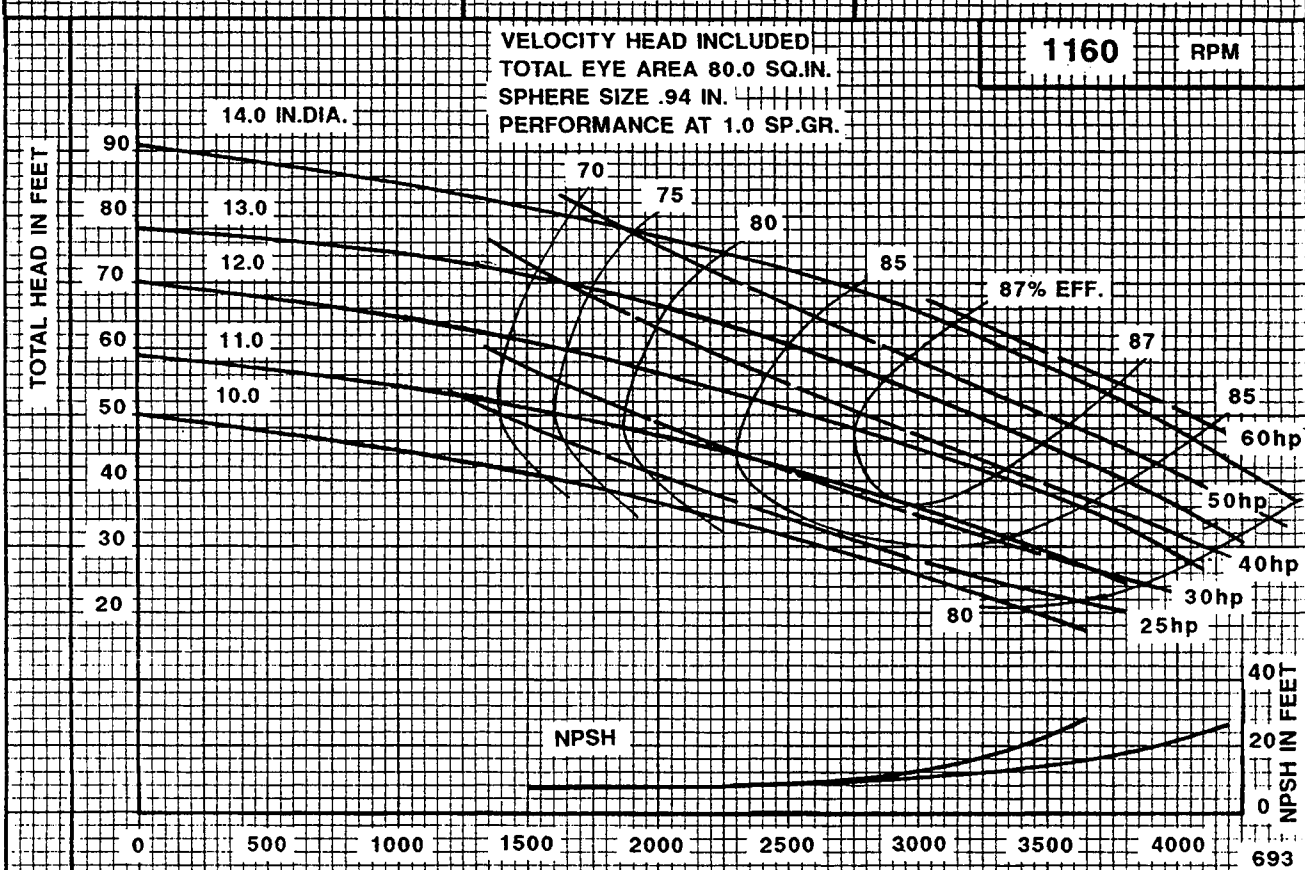

IMPELLER 2693192

U.S. GALLONS PER MINUTE

CURVE 3132133



Peerless Pump Company
Indianapolis, IN 46207-7026

HORIZONTAL SPLIT CASE PUMPS

Type 10AE14J Size 10 x 12 x 14

SECTION 1240

VELOCITY HEAD INCLUDED
TOTAL EYE AREA 80.0 SQ.IN.
SPHERE SIZE .94 IN.
PERFORMANCE AT 1.0 SP.GR.

1770 RPM

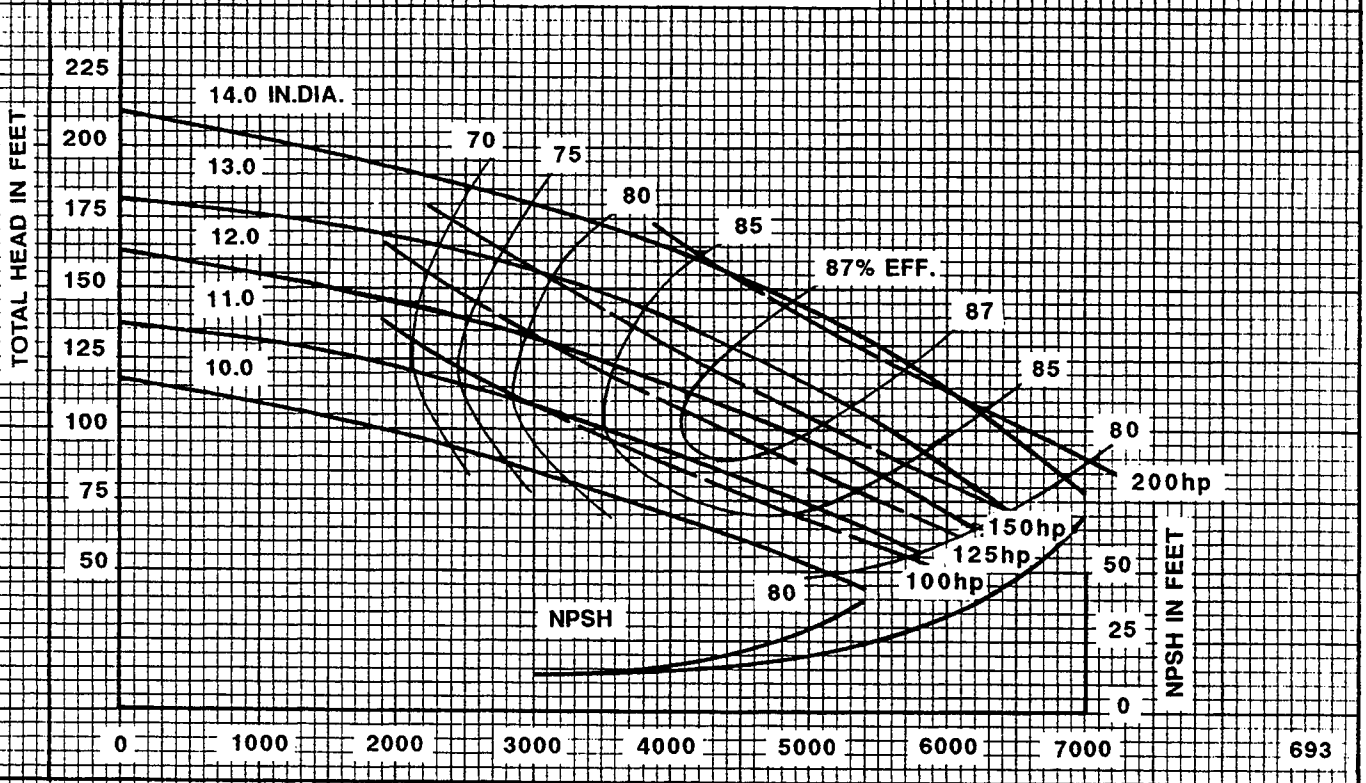

IMPELLER 2693192

U.S. GALLONS PER MINUTE

CURVE 3132131

693



Peerless Pump Company
Indianapolis, IN 46207-7026

HORIZONTAL SPLIT CASE PUMPS
Type 10AE16 Size 10 x 12 x 16

SECTION 1240

870

RPM

VELOCITY HEAD INCLUDED
TOTAL EYE AREA 100.0 SQ.IN.
SPHERE SIZE 1.12 IN.
PERFORMANCE AT 1.0 SP.GR.

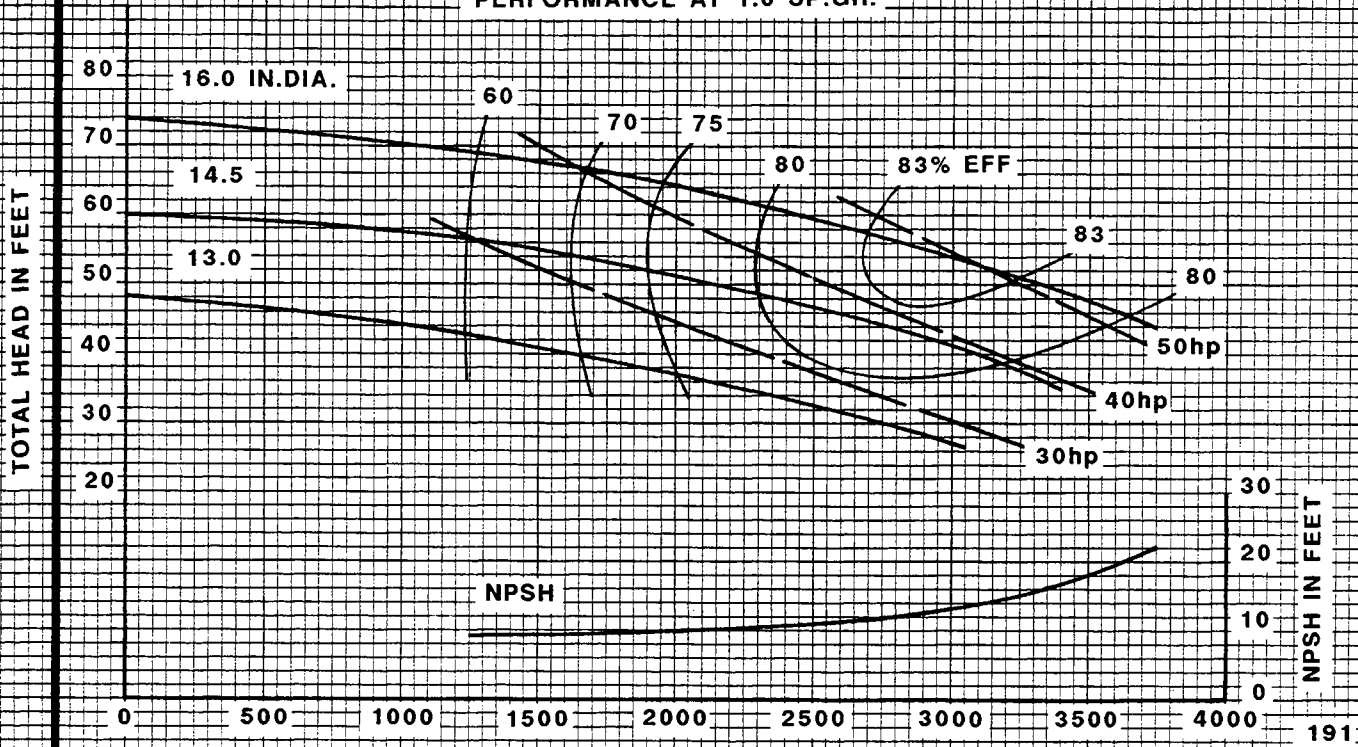

IMPELLER 2692881

U.S. GALLONS PER MINUTE

CURVE 3132126



Peerless Pump Company
Indianapolis, IN 46207-7026

HORIZONTAL SPLIT CASE PUMPS

Type 10AE16

Size 10 x 12 x 16

SECTION 1240

1165 RPM

VELOCITY HEAD INCLUDED
TOTAL EYE AREA 100.0 SQ. IN.
SPHERE SIZE 1.12 IN.
PERFORMANCE AT 1.0 SP. GR.

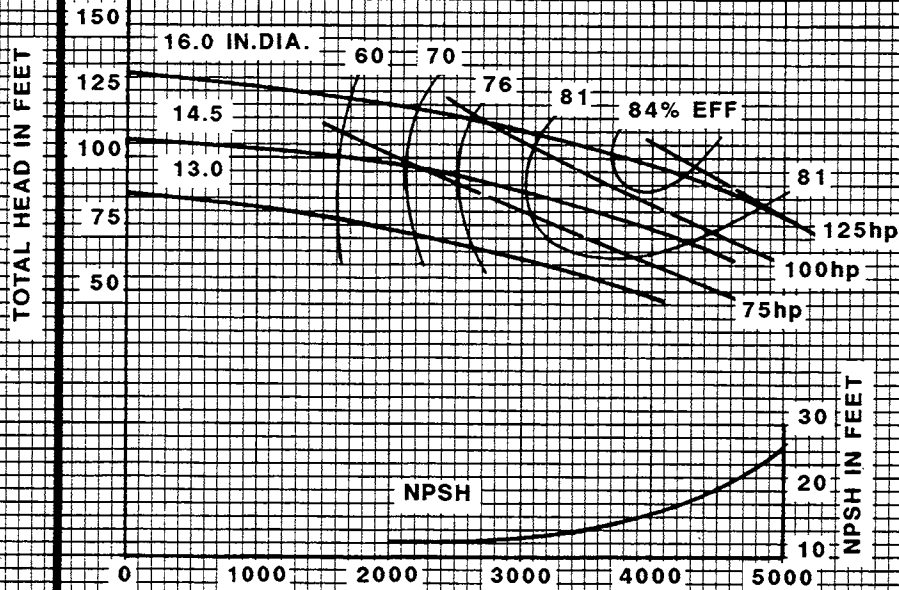

IMPELLER 2692881

U.S. GALLONS PER MINUTE

CURVE 3132125

1775 RPM

VELOCITY HEAD INCLUDED
TOTAL EYE AREA 100.0 SQ. IN.
SPHERE SIZE 1.12 IN.
PERFORMANCE AT 1.0 SP. GR.

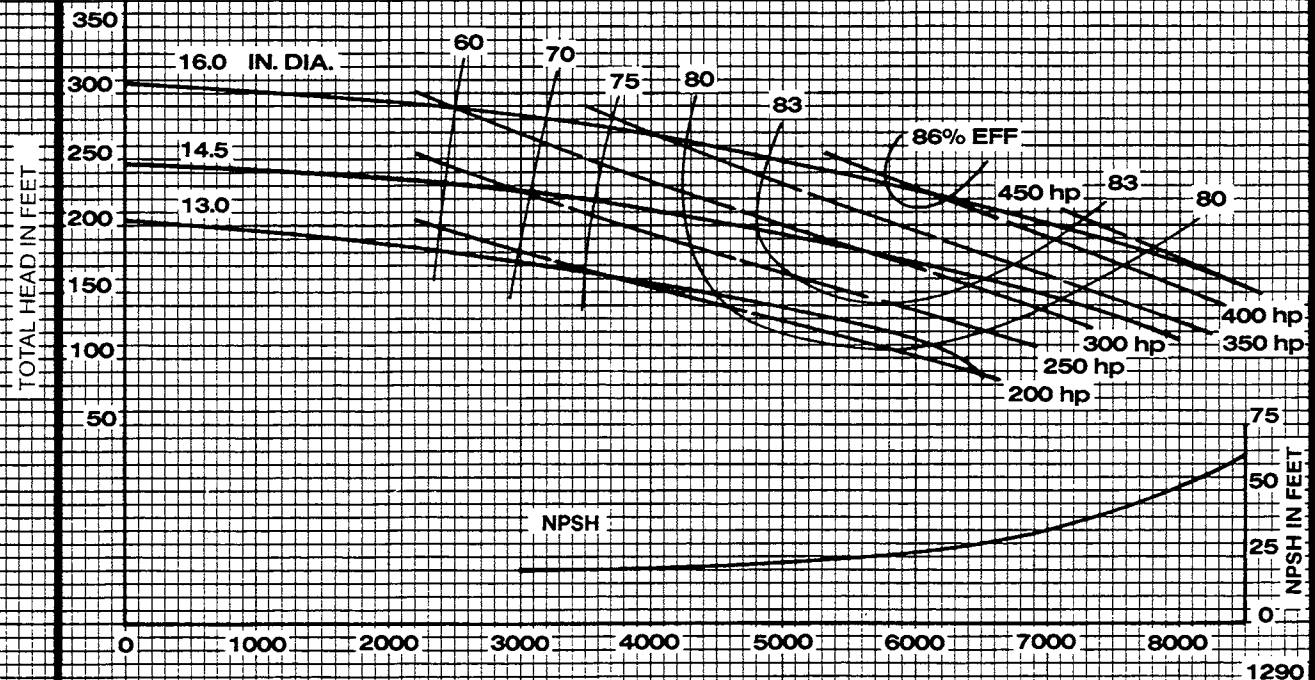

IMPELLER 2692881

U.S. GALLONS PER MINUTE

CURVE 3132120



Peerless Pump Company
Indianapolis, IN 46207-7025

HORIZONTAL SPLIT CASE PUMPS

Type 10AE20

Size 10 x 12 x 20

SECTION 1240

1165 RPM

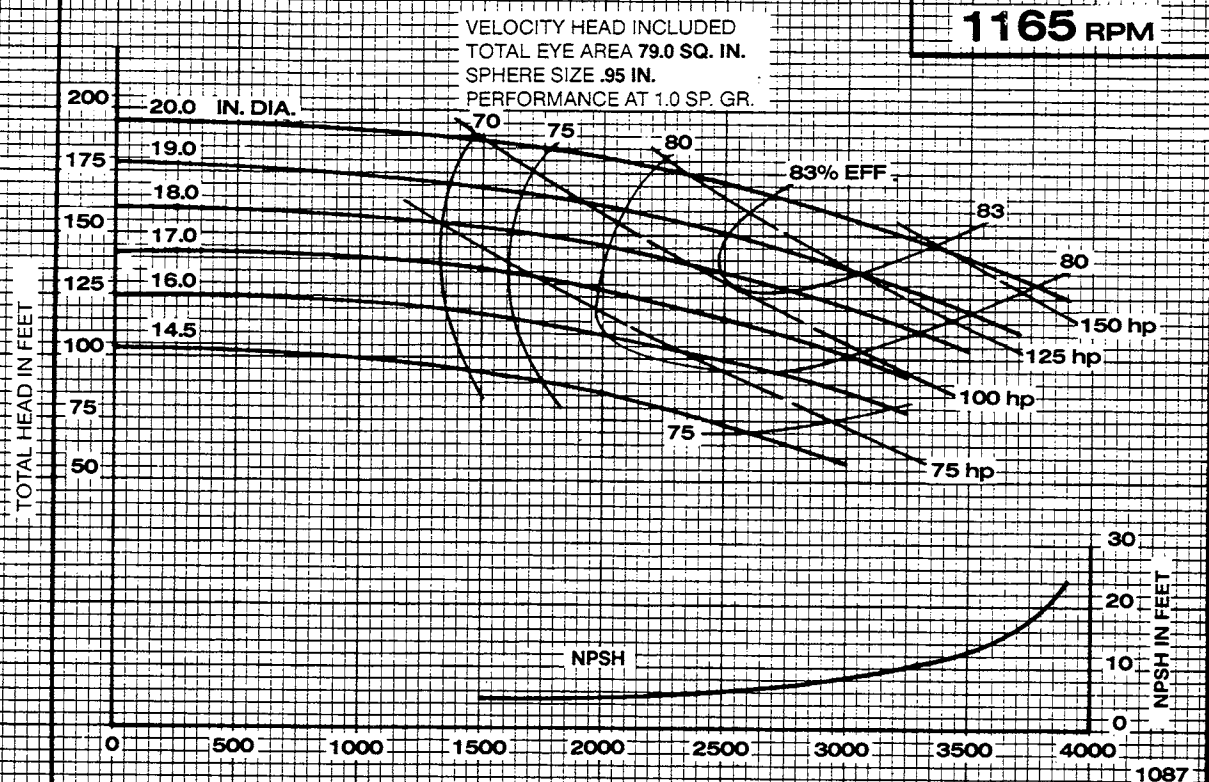

1775 RPM

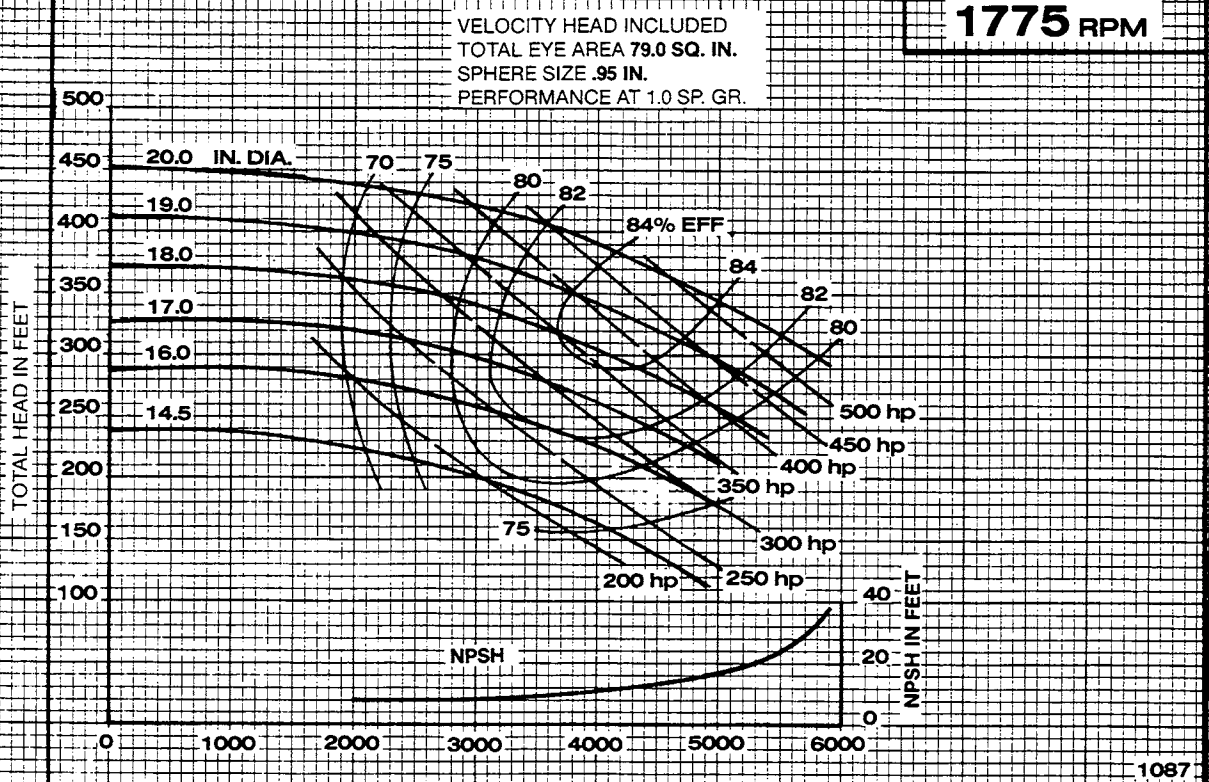



Peerless Pump Company
Indianapolis, IN 46207-7026

HORIZONTAL SPLIT CASE PUMPS
Type 2AE11 Size 2x3x10.38

SECTION 1240

1450 RPM

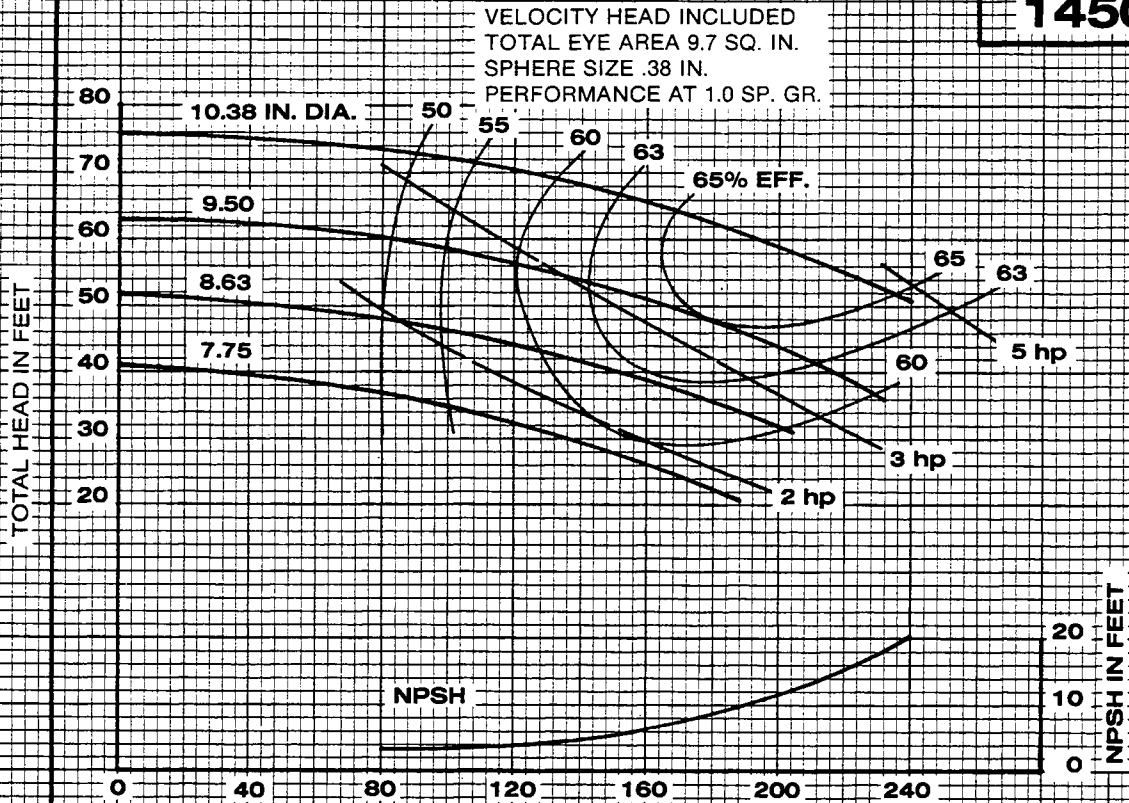

287

IMPELLER **2693522**

U.S. GALLONS PER MINUTE

CURVE **3132043**

2900 RPM

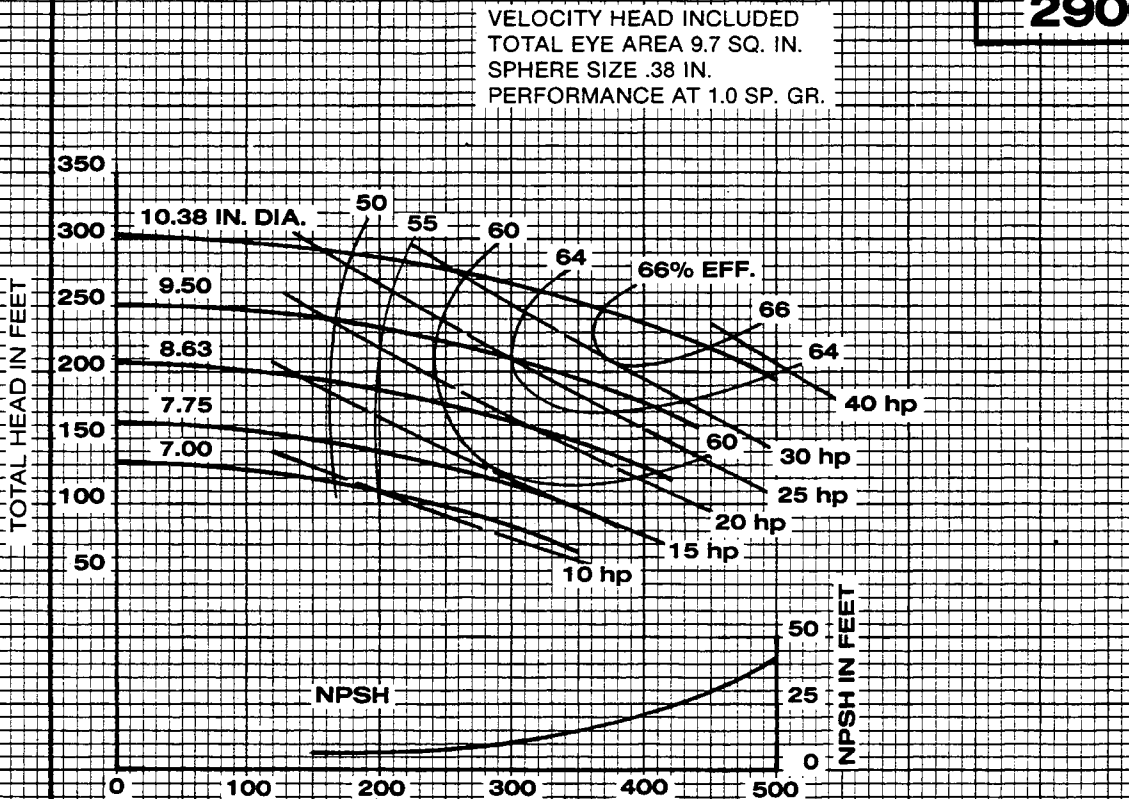

Rev. 787

IMPELLER **2693522**

U.S. GALLONS PER MINUTE

CURVE **3132041**



Peerless Pump Company
Indianapolis, IN 46207-7026

HORIZONTAL SPLIT CASE PUMPS
Type 3AE9 Size 3x4x9.00

SECTION 1240

2935 RPM

VELOCITY HEAD INCLUDED
TOTAL EYE AREA 12.2 SQ. IN.
SPHERE SIZE .56 IN.
PERFORMANCE AT 1.0 SP. GR.

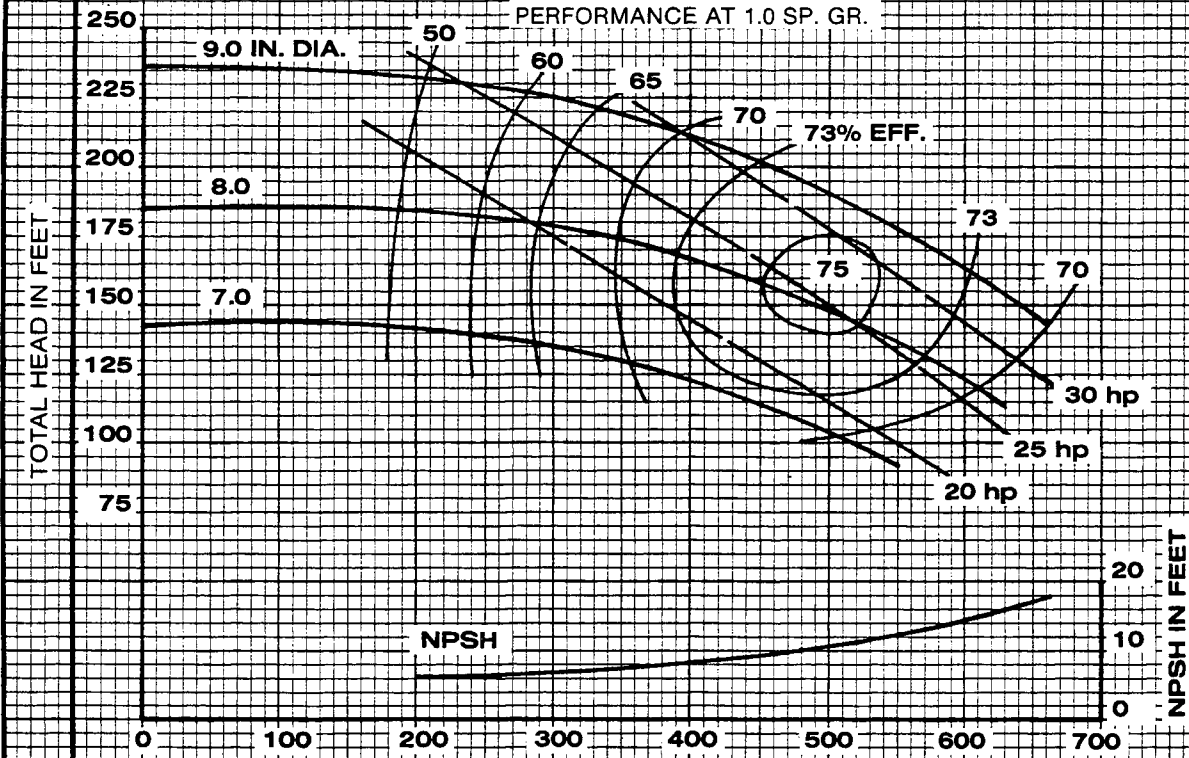

587

IMPELLER **2693450**

U.S. GALLONS PER MINUTE

CURVE **3132064**



Peerless Pump Company
Indianapolis, IN 46207-7026

HORIZONTAL SPLIT CASE PUMPS
Type 3AE9G Size 3x4x9.00

SECTION 1240

2935 RPM

VELOCITY HEAD INCLUDED
TOTAL EYE AREA 12.2 SQ. IN.
SPHERE SIZE .56 IN.
PERFORMANCE AT 1.0 SP. GR.

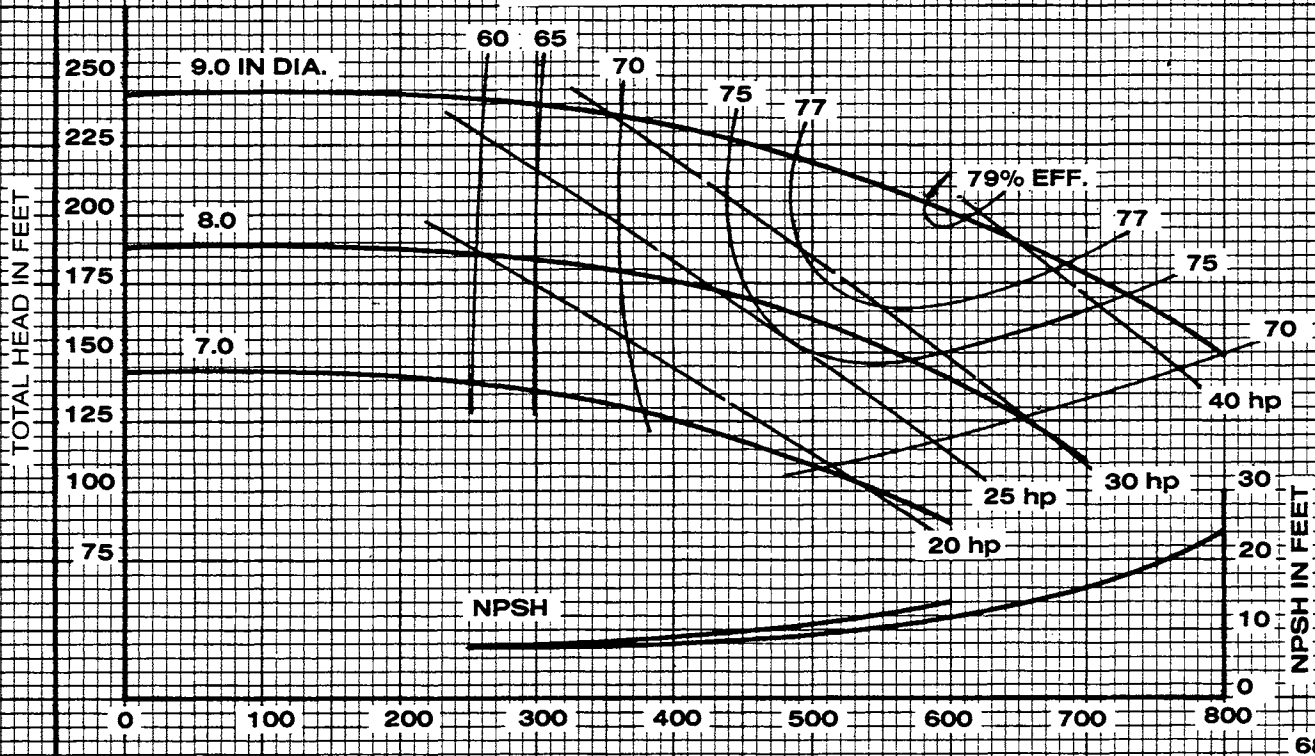

IMPELLER **2693451**

U.S. GALLONS PER MINUTE

CURVE **3132061**



Peerless Pump Company
Indianapolis, IN 46207-7026

HORIZONTAL SPLIT CASE PUMPS
Type 3AE14 Size 3x4x14.00

SECTION 1240

1450 RPM

VELOCITY HEAD INCLUDED
TOTAL EYE AREA 14.9 SQ. IN.
SPHERE SIZE .40 IN.
PERFORMANCE AT 1.0 SP. GR.

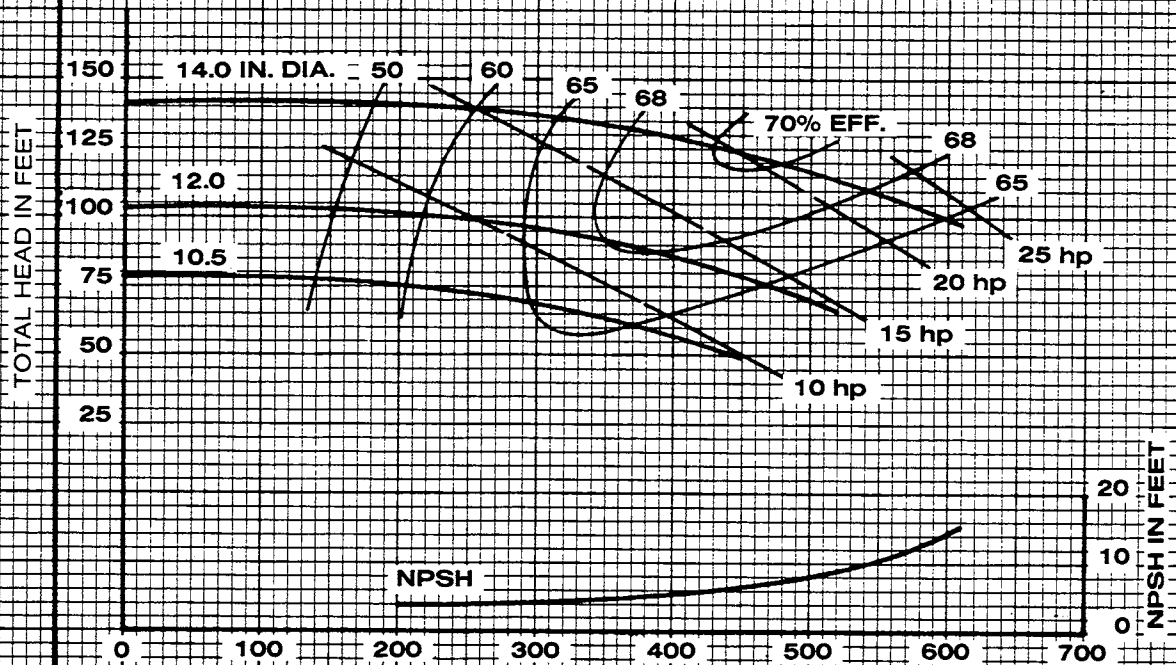

287

IMPELLER 2693509

U.S. GALLONS PER MINUTE

CURVE 3132048



Peerless Pump Company
Indianapolis, IN 46207-7026

HORIZONTAL SPLIT CASE PUMPS
Type 3AE14G Size 3 x 4 x 13

SECTION 1240

1450 RPM

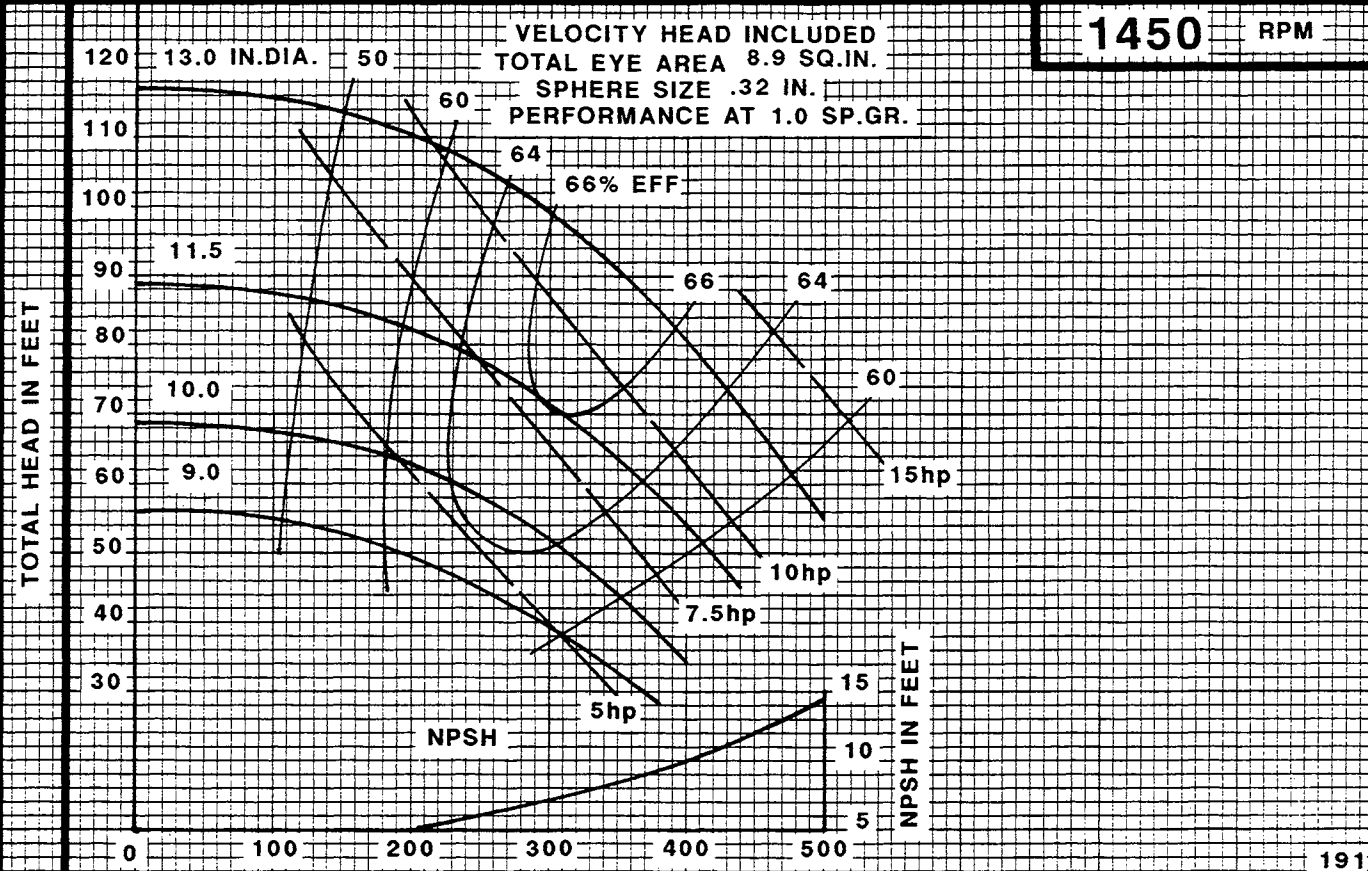

IMPELLER 2694939

U.S. GALLONS PER MINUTE

CURVE 3132122



Peerless Pump Company
Indianapolis, IN 46207-7026

HORIZONTAL SPLIT CASE PUMPS
Type 4AE10 Size 4 x 5 x 10.00

SECTION 1240

1450 RPM

VELOCITY HEAD INCLUDED
TOTAL EYE AREA 18.1 SQ. IN.
SPHERE SIZE .56 IN.
PERFORMANCE AT 1.0 SP. GR.

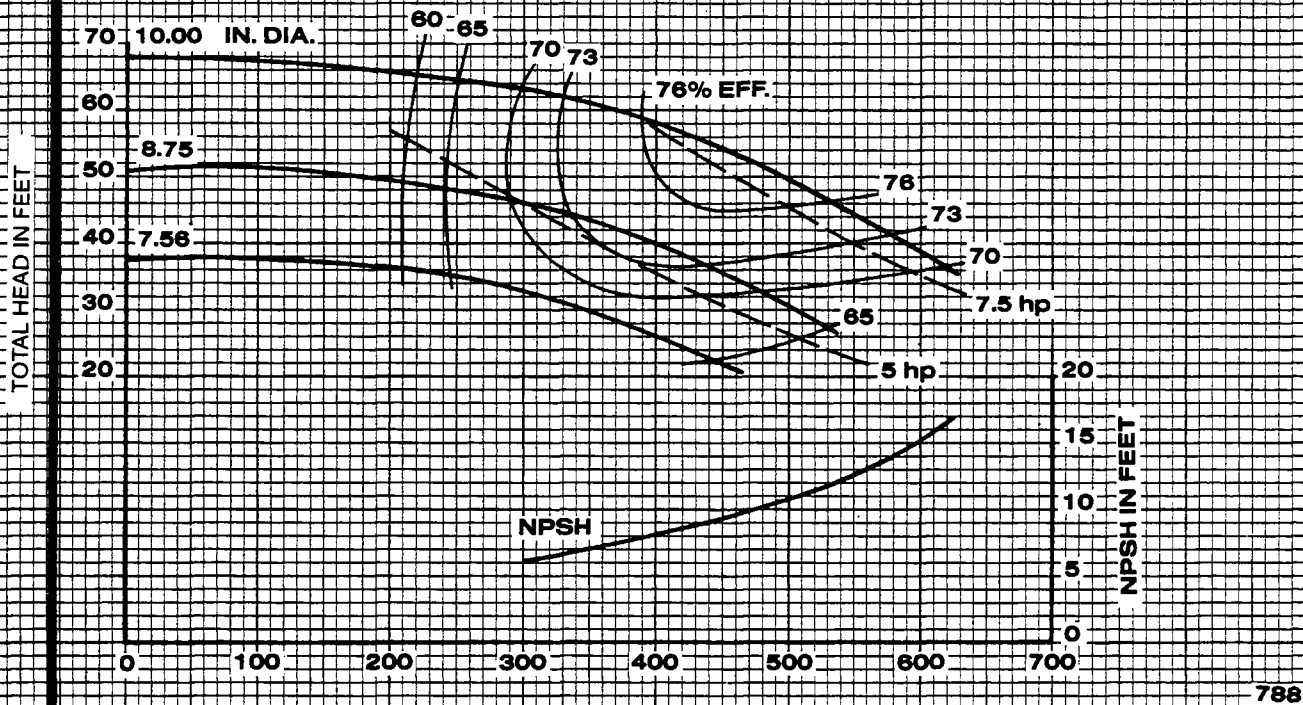

IMPELLER 2693319

U.S. GALLONS PER MINUTE

CURVE 3132104

2950 RPM

VELOCITY HEAD INCLUDED
TOTAL EYE AREA 18.1 SQ. IN.
SPHERE SIZE .56 IN.
PERFORMANCE AT 1.0 SP. GR.

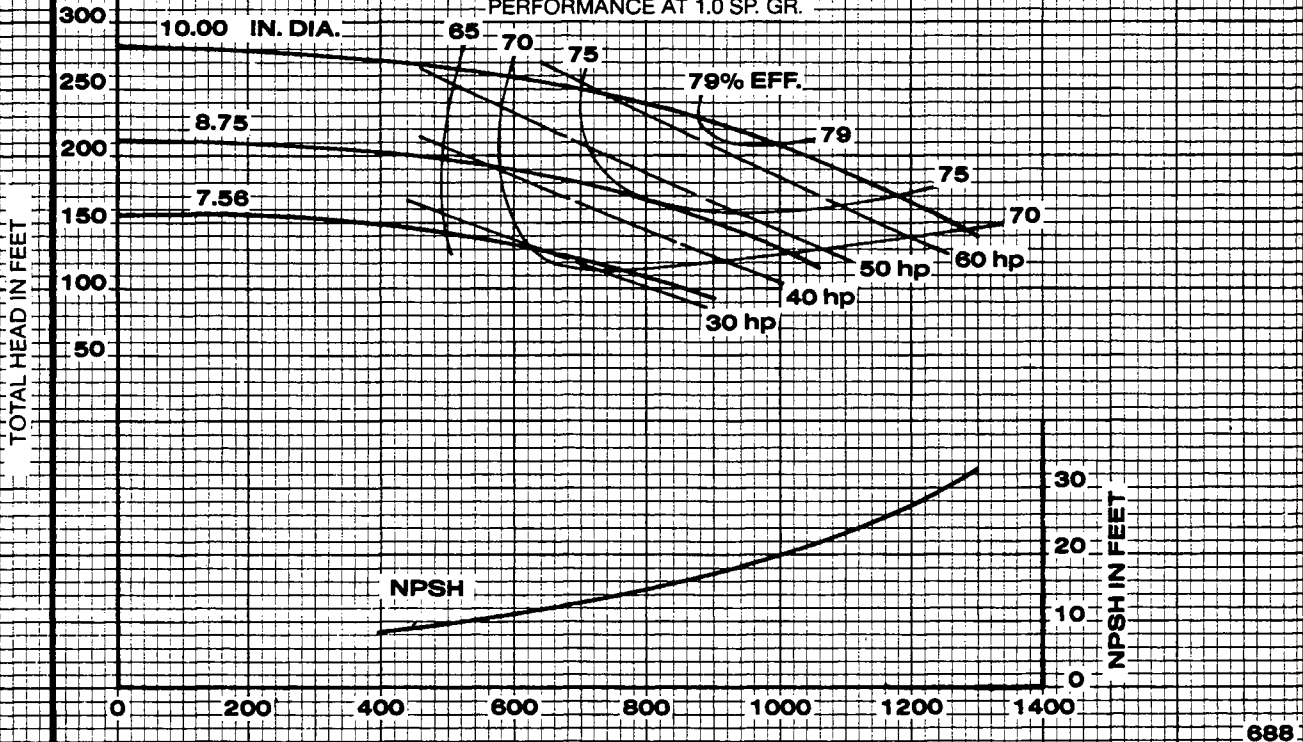

IMPELLER 2693319

U.S. GALLONS PER MINUTE

CURVE 3132011



Peerless Pump Company
Indianapolis, IN 46207-7026

HORIZONTAL SPLIT CASE PUMPS
Type 4AE10G Size 4 x 5 x 9

SECTION 1240

2935 RPM

VELOCITY HEAD INCLUDED
TOTAL EYE AREA 12.2 SQ. IN.
SPHERE SIZE .56 IN.
PERFORMANCE AT 1.0 SP. GR.

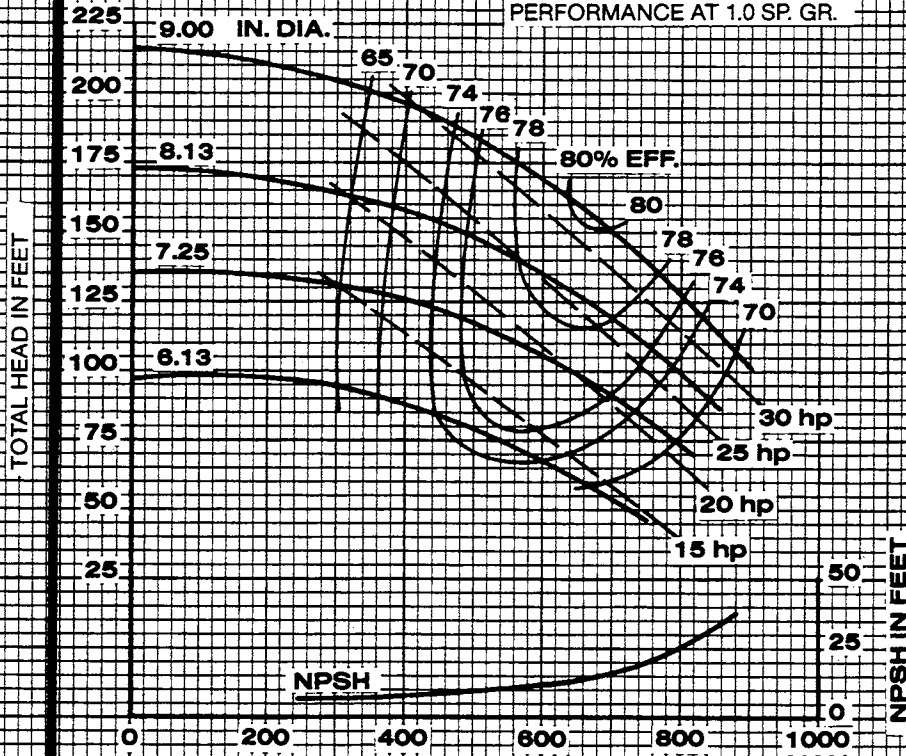

IMPELLER 2693450

U.S. GALLONS PER MINUTE

CURVE 3132091



Peerless Pump Company
Indianapolis, IN 46207-7026

HORIZONTAL SPLIT CASE PUMPS
Type 4AE11 Size 4x5x11.25

SECTION 1240

1450 RPM

VELOCITY HEAD INCLUDED
TOTAL EYE AREA 28.50 SQ. IN.
SPHERE SIZE .72 IN.
PERFORMANCE AT 1.0 SP. GR.

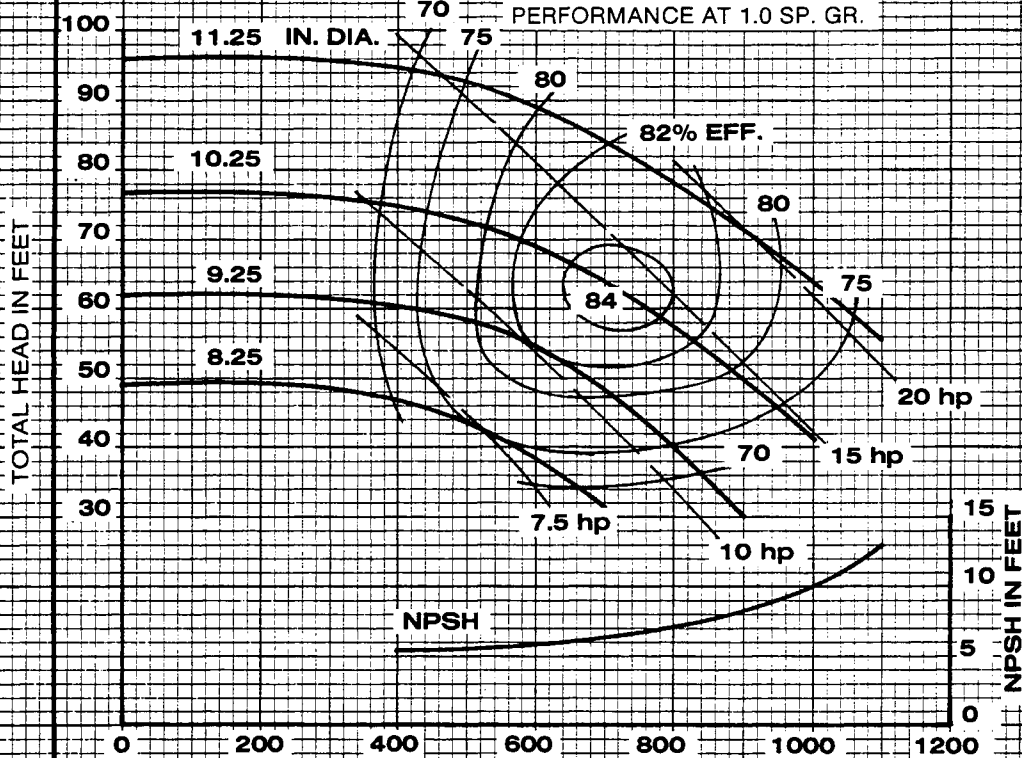

586

IMPELLER 2692930

U.S. GALLONS PER MINUTE

CURVE 3132004



Peerless Pump Company
Indianapolis, IN 46207-7026

HORIZONTAL SPLIT CASE PUMPS
Type 4AE11G Size 4x5x11.25

SECTION 1240

1450 RPM

VELOCITY HEAD INCLUDED
TOTAL EYE AREA 18.04 SQ. IN.
SPHERE SIZE .62 IN.
PERFORMANCE AT 1.0 SP. GR.

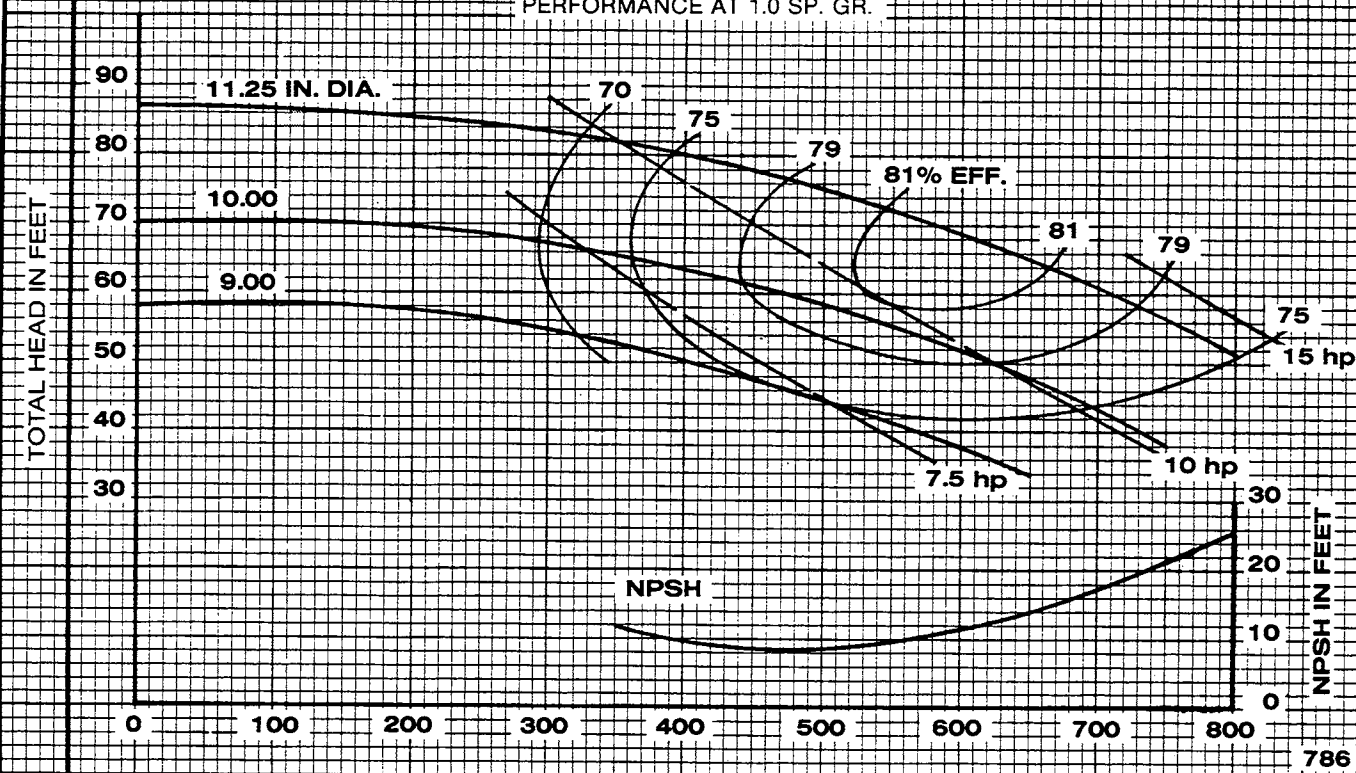

786

IMPELLER 2693667	U.S. GALLONS PER MINUTE	CURVE 3132014
-------------------------	-------------------------	----------------------



Peerless Pump Company
Indianapolis, IN 46207-7026

HORIZONTAL SPLIT CASE PUMPS
Type 4AE12 Size 4x5x12.12

SECTION 1240

1450 RPM

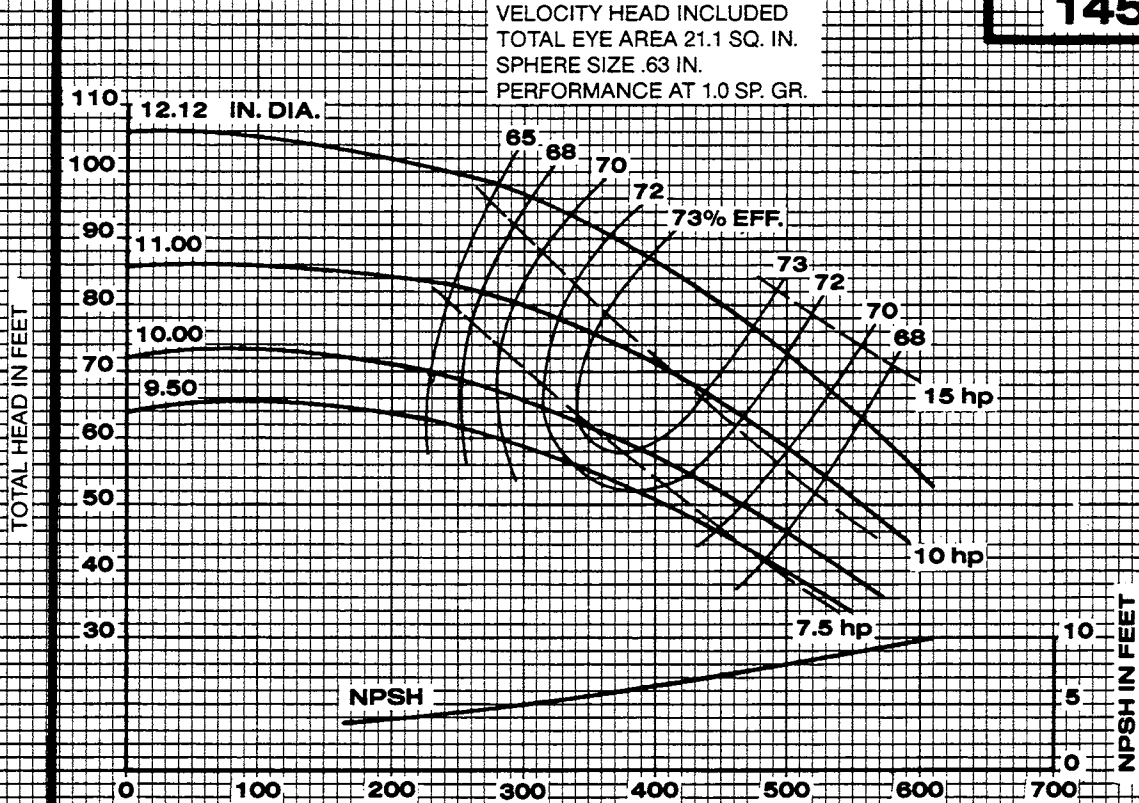

788

IMPELLER 2692300

U.S. GALLONS PER MINUTE

CURVE 3132103

2950 RPM

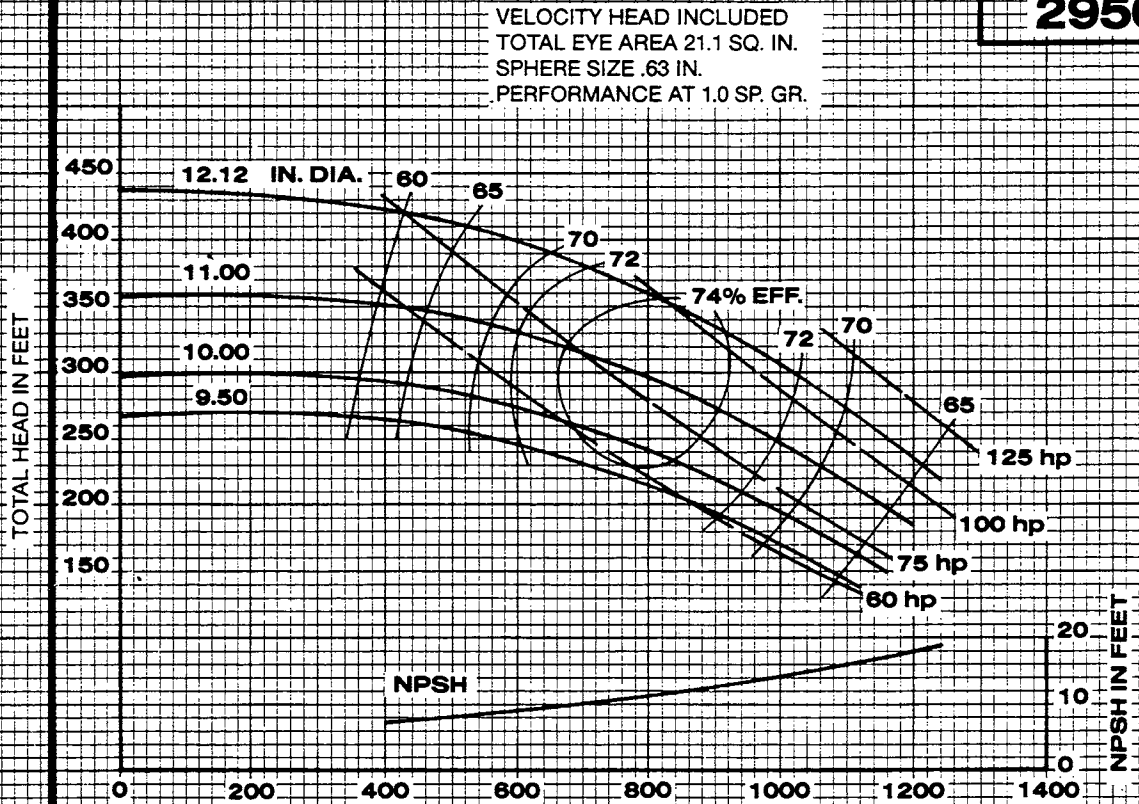

486

IMPELLER 2692300

U.S. GALLONS PER MINUTE

CURVE 3132001



Peerless Pump Company
Indianapolis, IN 46207-7026

HORIZONTAL SPLIT CASE PUMPS
Type 5AE8 Size 5x6x8.12

SECTION 1240

2950 RPM

VELOCITY HEAD INCLUDED
TOTAL EYE AREA 26.3 SQ. IN.
SPHERE SIZE .62 IN.
PERFORMANCE AT 1.0 SP. GR.

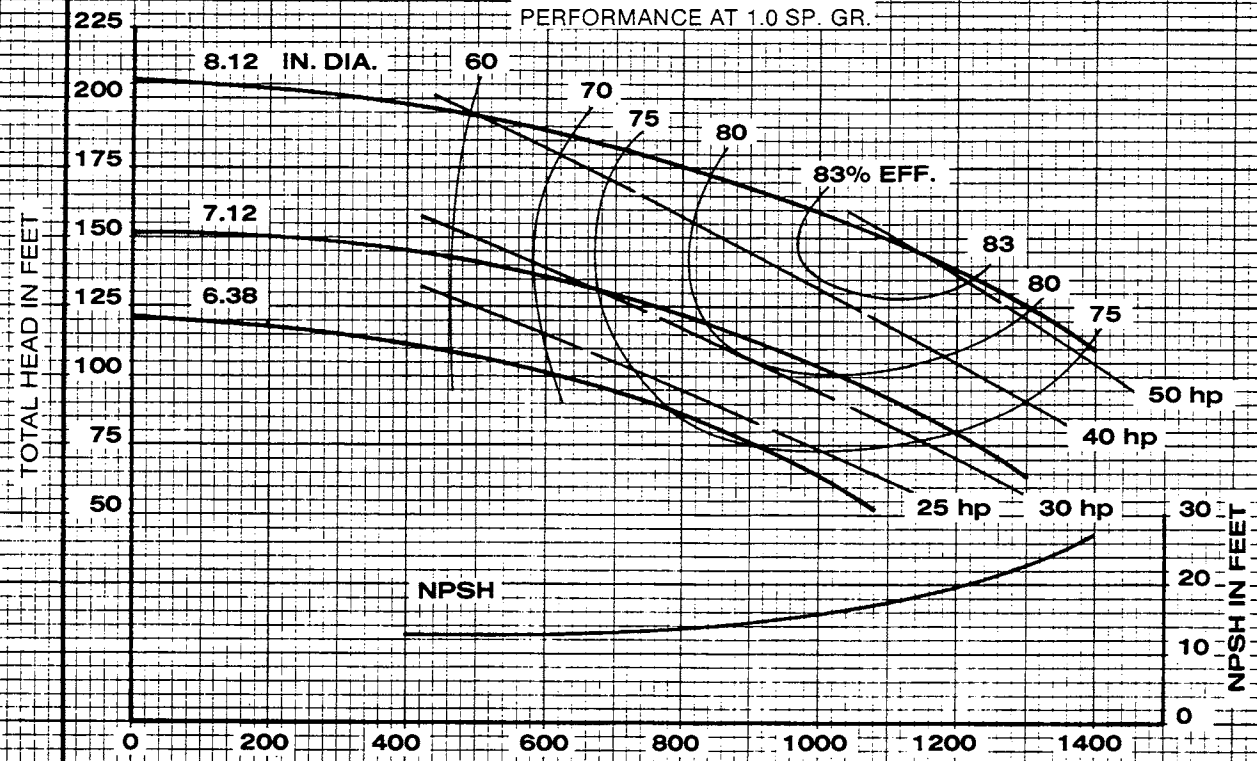

IMPELLER **2693814**

U.S. GALLONS PER MINUTE

CURVE **3112035**

786



Peerless Pump Company
Indianapolis, IN 46207-7026

HORIZONTAL SPLIT CASE PUMPS
Type 5AE8N Size 5 x 6 x 8.25

SECTION 1240

2950 RPM

VELOCITY HEAD INCLUDED
TOTAL EYE AREA 24.7 SQ. IN.
SPHERE SIZE .63 IN.
PERFORMANCE AT 1.0 SP. GR.

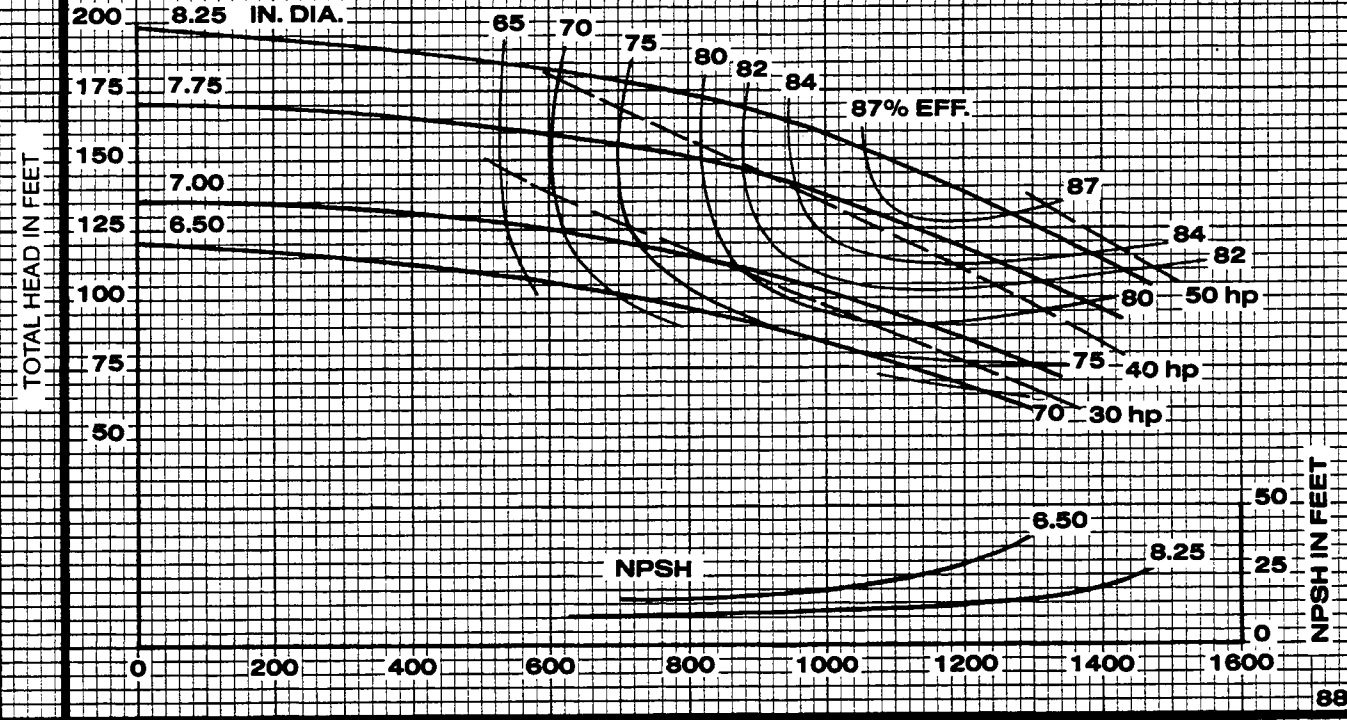

IMPELLER **2693816**

U.S. GALLONS PER MINUTE

CURVE **3132106**



Peerless Pump Company
Indianapolis, IN 46207-7026

HORIZONTAL SPLIT CASE PUMPS
Type 5AE11 Size 5x6x10.50

SECTION 1240

2950 RPM

VELOCITY HEAD INCLUDED
TOTAL EYE AREA 24.7 SQ. IN.
SPHERE SIZE .56 IN.
PERFORMANCE AT 1.0 SP. GR.

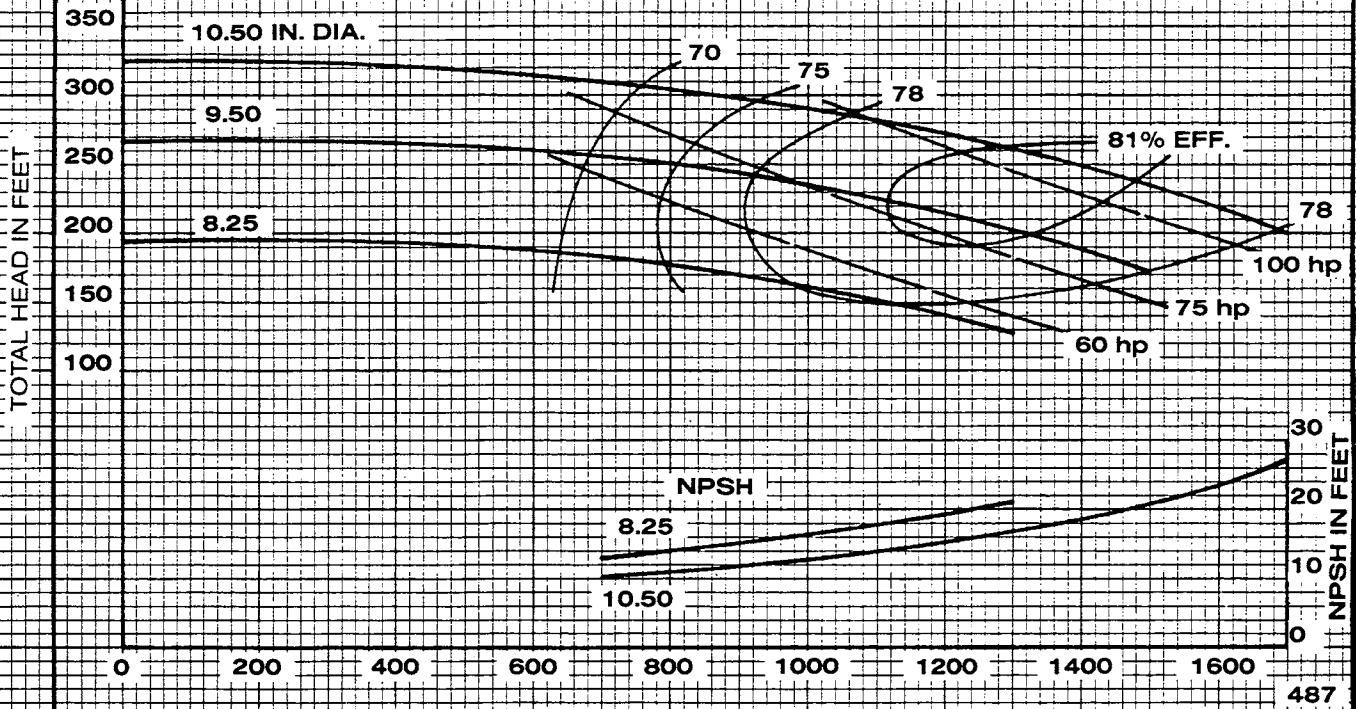

IMPELLER **2693430**

U.S. GALLONS PER MINUTE

CURVE **3132051**



Peerless Pump Company
Indianapolis, IN 46207-7026

HORIZONTAL SPLIT CASE PUMPS
Type 5AE11G Size 5x6x10.50

SECTION 1240

2950 RPM

VELOCITY HEAD INCLUDED
TOTAL EYE AREA 23.5 SQ. IN.
SPHERE SIZE .69 IN.
PERFORMANCE AT 1.0 SP. GR.

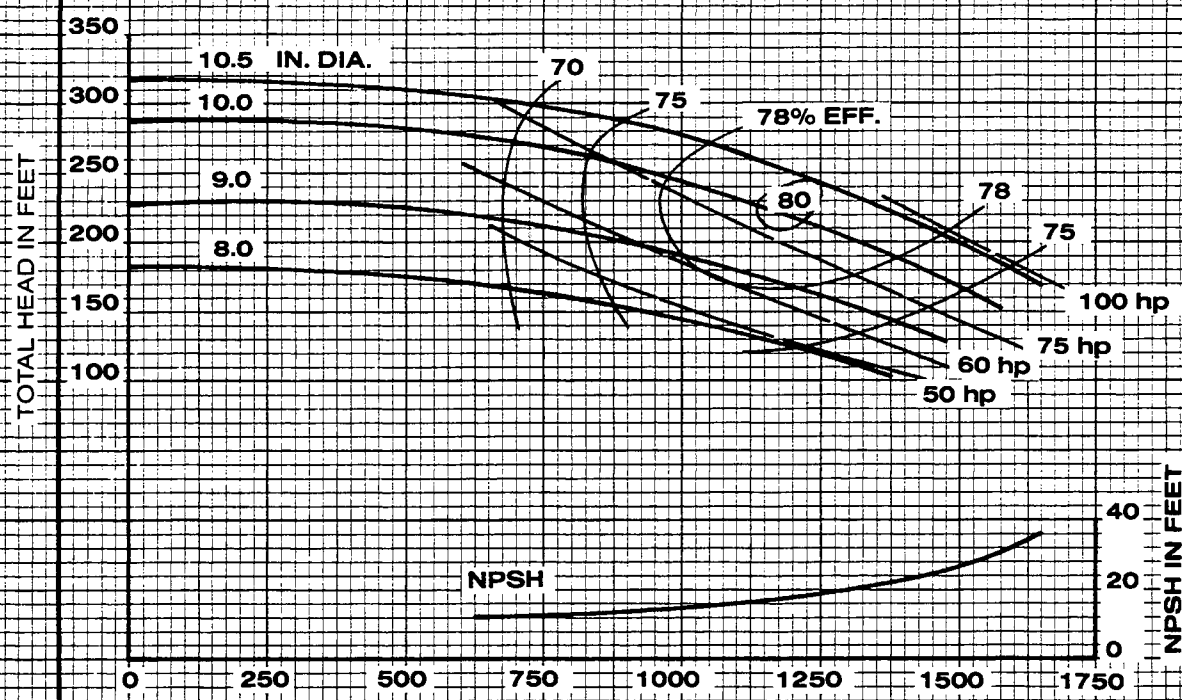

IMPELLER **2693431**

U.S. GALLONS PER MINUTE

CURVE **3132085**



Peerless Pump Company
Indianapolis, IN 46207-7026

HORIZONTAL SPLIT CASE PUMPS
Type 5AE12 Size 5x6x12.00

SECTION 1240

2950 RPM

VELOCITY HEAD INCLUDED
TOTAL EYE AREA 30.3 SQ. IN.
SPHERE SIZE .63 IN.
PERFORMANCE AT 1.0 SP. GR.

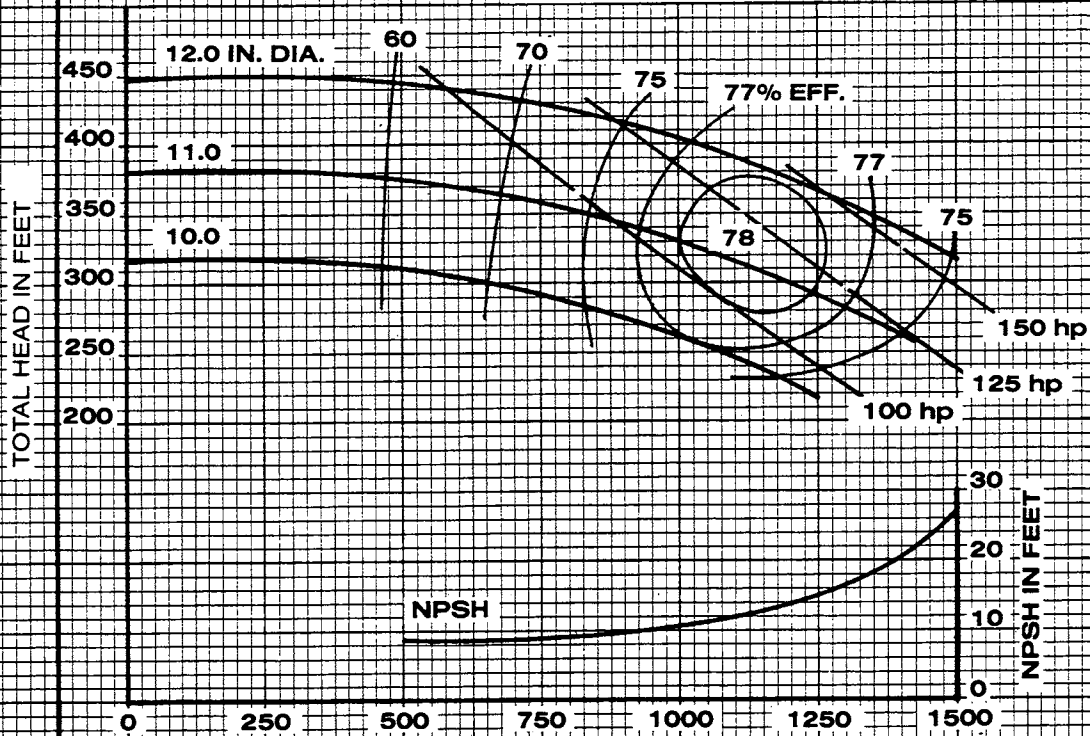

687

IMPELLER **2693460**

U.S. GALLONS PER MINUTE

CURVE **3132067**



Peerless Pump Company
Indianapolis, IN 46207-7026

HORIZONTAL SPLIT CASE PUMPS
Type 5AE14 Size 5x6x14.00

SECTION 1240

1450 RPM

VELOCITY HEAD INCLUDED
TOTAL EYE AREA 25.14 SQ. IN.
SPHERE SIZE .70 IN.
PERFORMANCE AT 1.0 SP. GR.

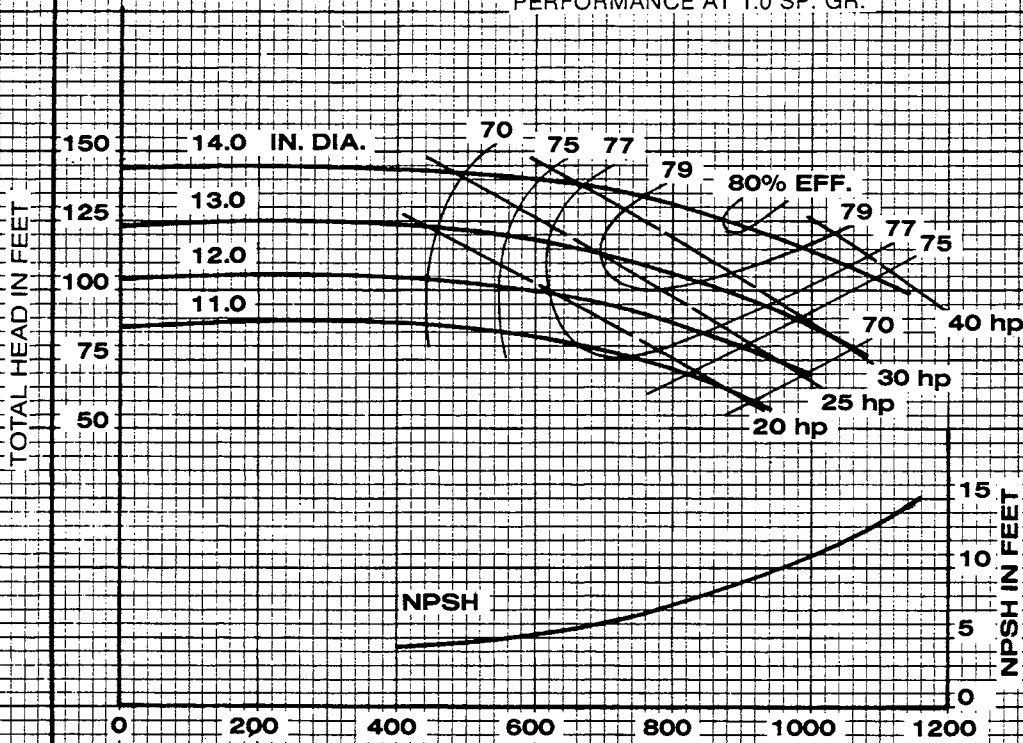

1186

IMPELLER **2693456**

U.S. GALLONS PER MINUTE

CURVE **3132031**



Peerless Pump Company
Indianapolis, IN 46207-7026

HORIZONTAL SPLIT CASE PUMPS
Type 5AE14G Size 5 x 6 x 14.00

SECTION 1240

1450 RPM

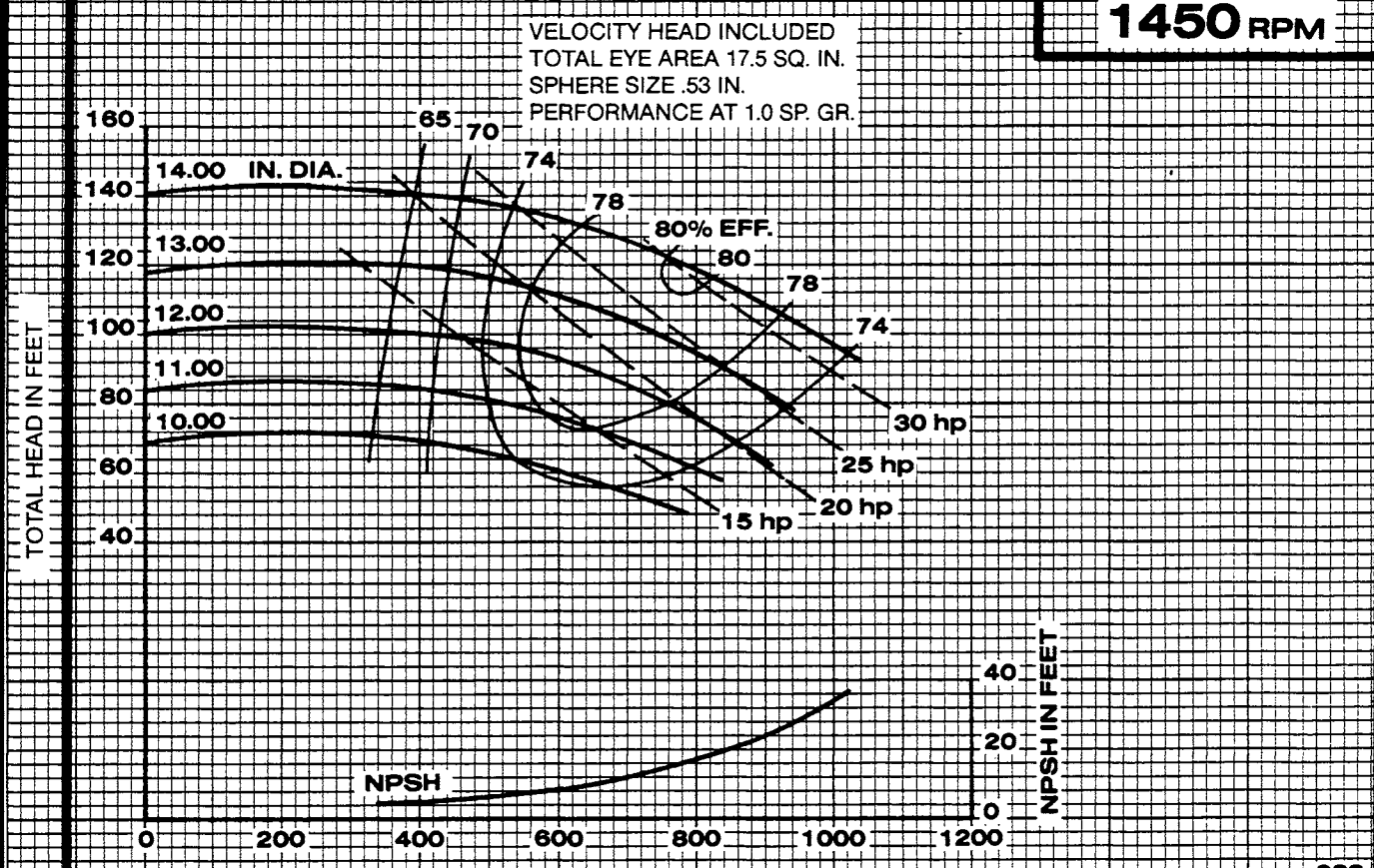

688

IMPELLER **2694349** U.S. GALLONS PER MINUTE CURVE **3132101**



Peerless Pump Company
Indianapolis, IN 46207-7025

HORIZONTAL SPLIT CASE PUMPS
Type 5AE14N Size 5 x 6 x 14

SECTION 1240

1450 RPM

VELOCITY HEAD INCLUDED
TOTAL EYE AREA 15.5 SQ. IN.
SPHERE SIZE .56 IN.
PERFORMANCE AT 1.0 SP. GR.

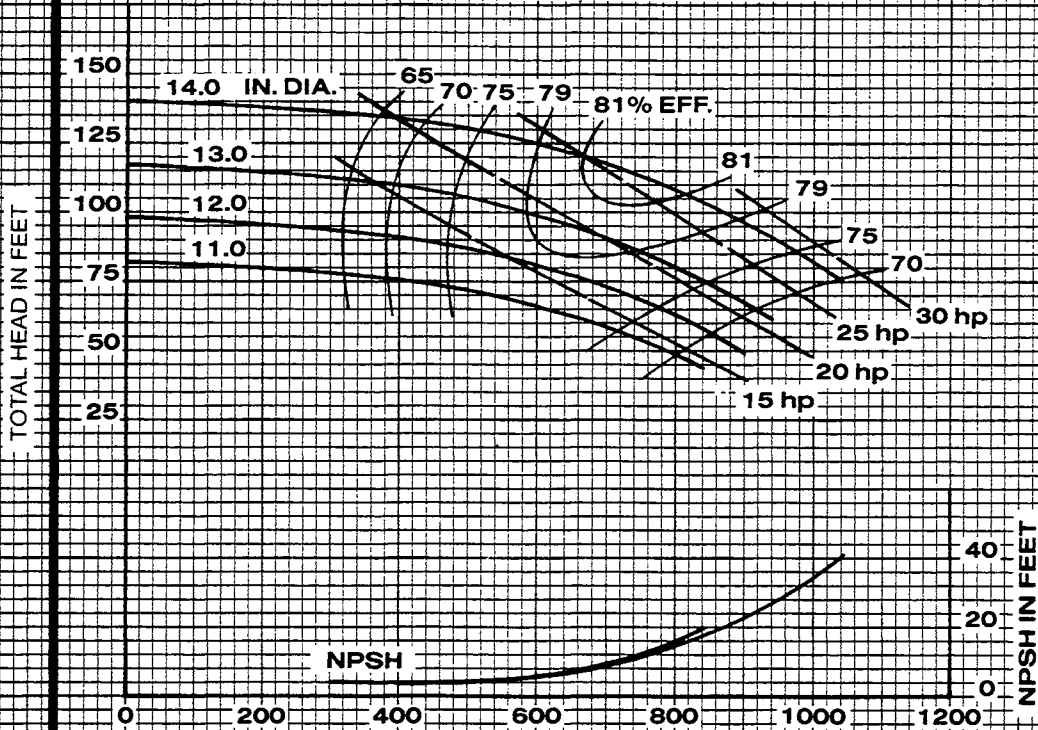

IMPELLER **2694394**

U.S. GALLONS PER MINUTE

CURVE **3132115**



Peerless Pump Company
Indianapolis, IN 46207-7026

HORIZONTAL SPLIT CASE PUMPS
Type 6AE11 Size 6x6x10.50

SECTION 1240

1450 RPM

VELOCITY HEAD INCLUDED
TOTAL EYE AREA 33.0 SQ. IN.
SPHERE SIZE .95 IN.
PERFORMANCE AT 1.0 SP. GR.

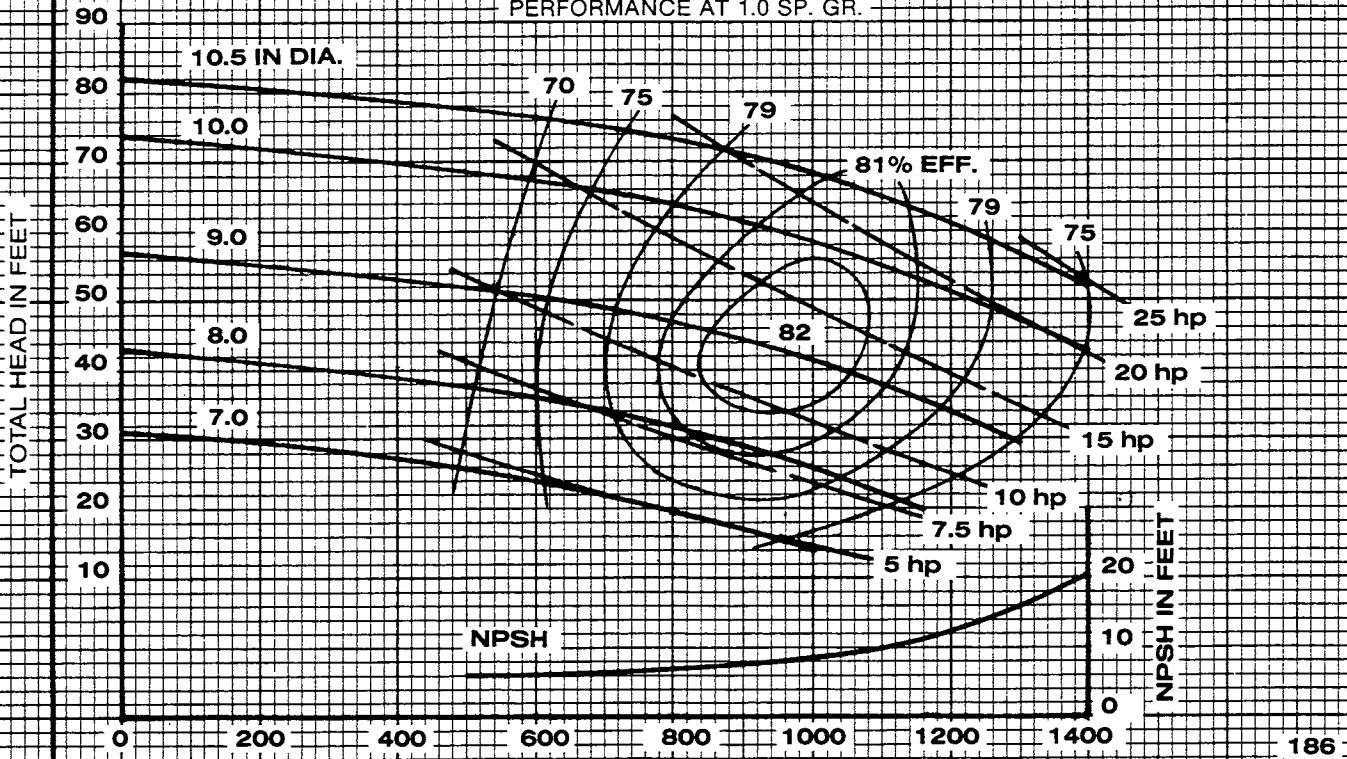

IMPELLER 2692848

U.S. GALLONS PER MINUTE

CURVE 3112033



Peerless Pump Company
Indianapolis, IN 46207-7026

HORIZONTAL SPLIT CASE PUMPS
Type 6AE12 Size 6x8x12.25

SECTION 1240

2950 RPM

VELOCITY HEAD INCLUDED
TOTAL EYE AREA 45.0 SQ. IN.
SPHERE SIZE .64 IN.
PERFORMANCE AT 1.0 SP. GR.

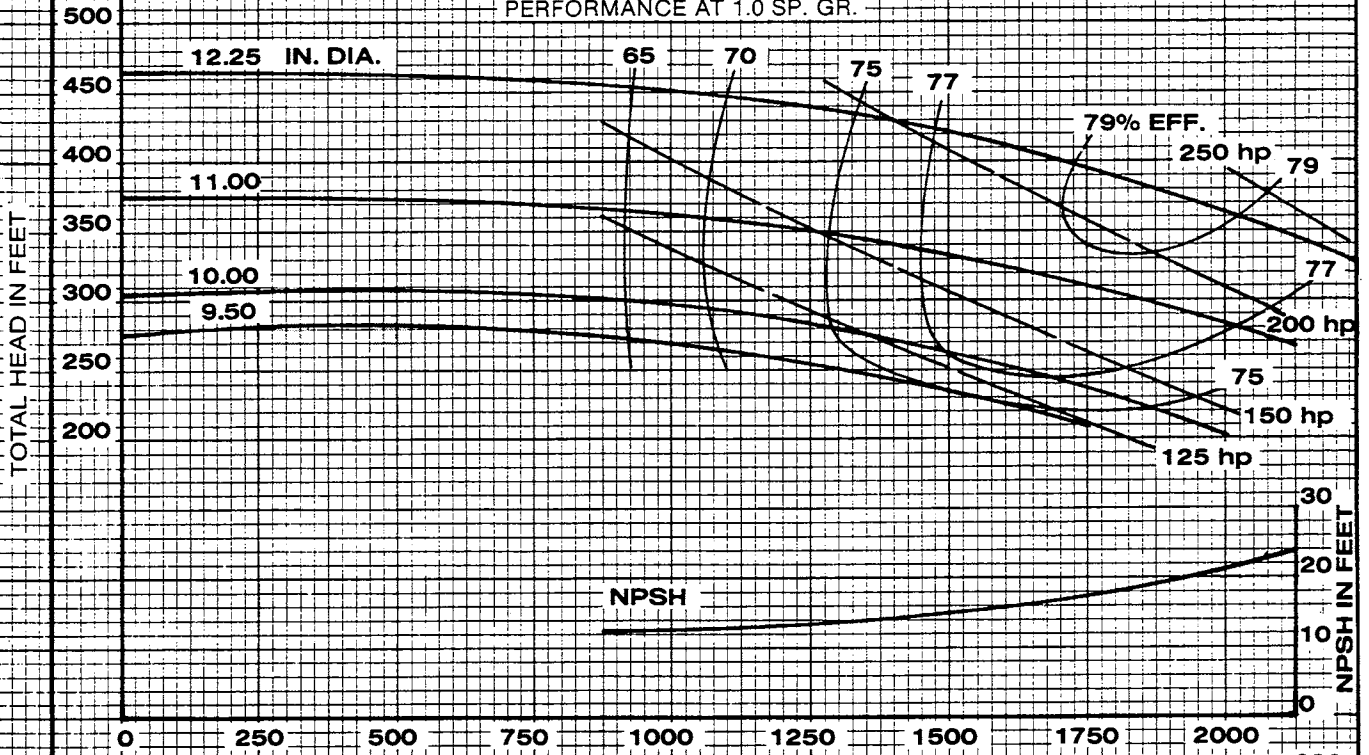

686

IMPELLER **2692443**

U.S. GALLONS PER MINUTE

CURVE **3132007**



Peerless Pump Company
Indianapolis, IN 46207-7026

HORIZONTAL SPLIT CASE PUMPS
Type 6AE14 Size 6x8x14.00

SECTION 1240

1450 RPM

VELOCITY HEAD INCLUDED
TOTAL EYE AREA 30.63 SQ. IN.
SPHERE SIZE .75 IN.
PERFORMANCE AT 1.0 SP. GR.

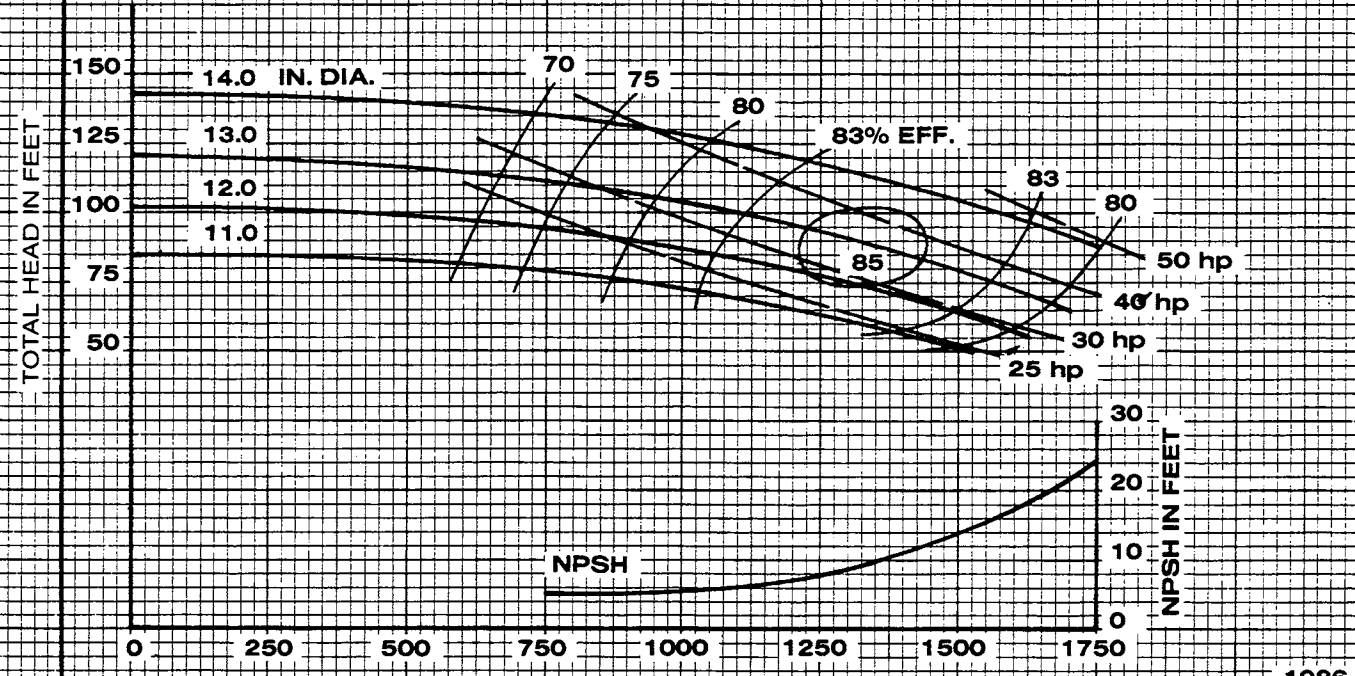

1086

IMPELLER 2693077	U.S. GALLONS PER MINUTE	CURVE 3132028
-------------------------	-------------------------	----------------------



Peerless Pump Company
Indianapolis, IN 46207-7026

HORIZONTAL SPLIT CASE PUMPS
Type 6AE14G Size 6x8x14.00

SECTION 1240

1450 RPM

VELOCITY HEAD INCLUDED
TOTAL EYE AREA 31.09 SQ. IN.
SPHERE SIZE .98 IN.
PERFORMANCE AT 1.0 SP. GR.

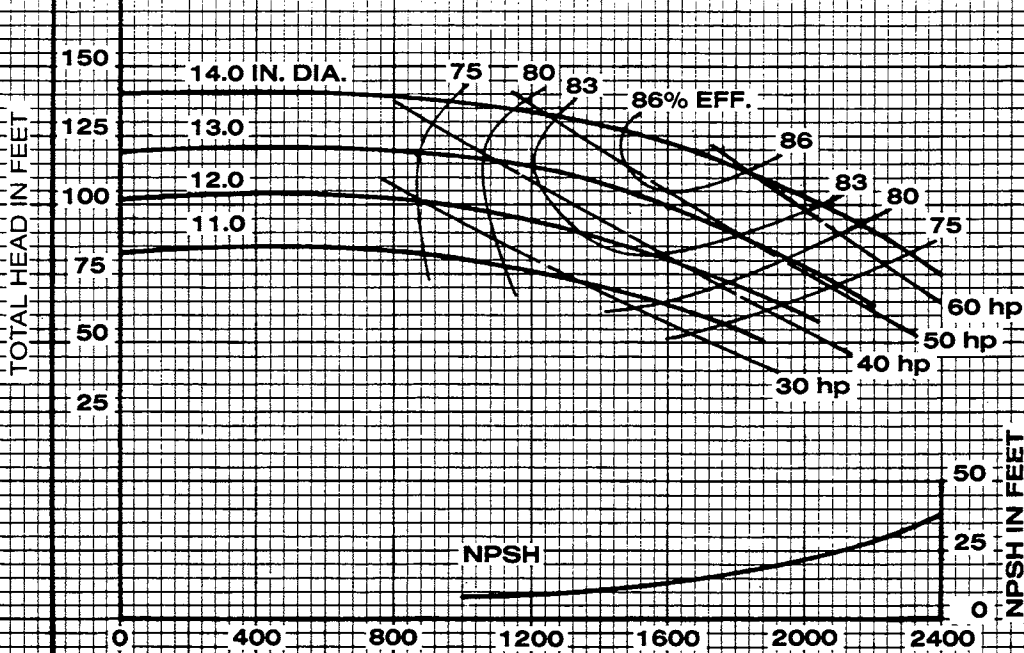

1286

IMPELLER **2693078**

U.S. GALLONS PER MINUTE

CURVE **3132034**



Peerless Pump Company
Indianapolis, IN 46207-7026

HORIZONTAL SPLIT CASE PUMPS
SINGLE STAGE DOUBLE SUCTION
Type 6AE14N Size 6 x 8 x 15.25

SECTION 1240

1450 RPM

**T
o
t
a
l
H
e
a
d
i
n
F
e
e
t**

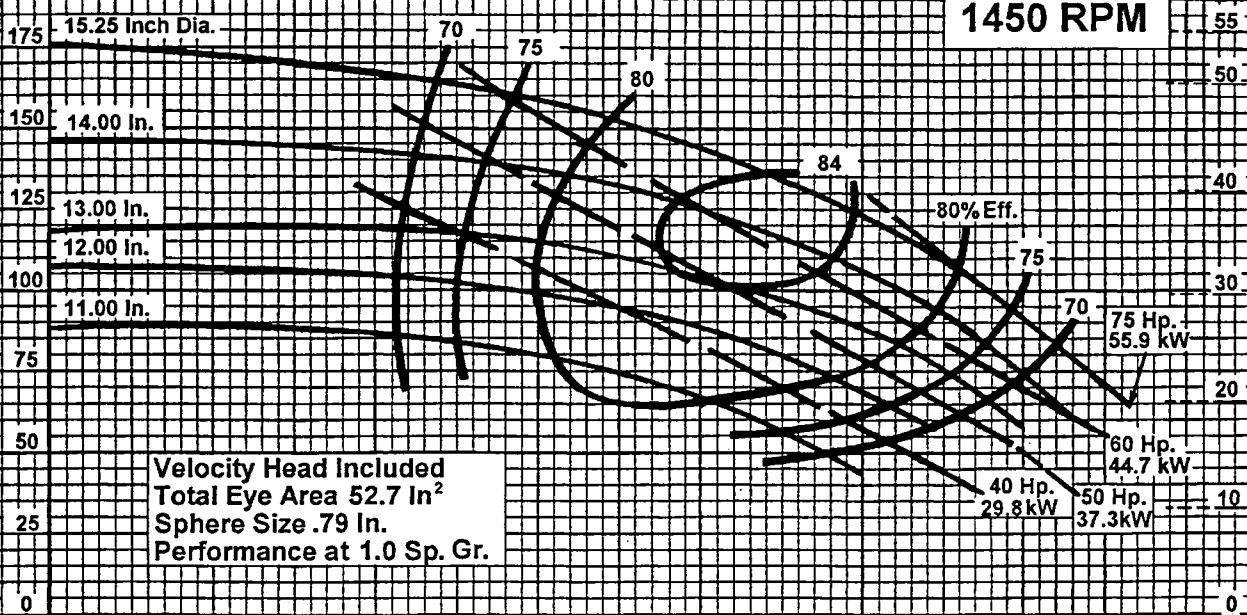

Total Head in Meters

0 400 800 1200 1600 2000 2400 2800

U.S. Gallons Per Minute

100 200 300 400 500 600

Cubic Meters Per Hour

Impeller 2696341

Curve 3122147



Peerless Pump Company
Indianapolis, IN 46207-7026

HORIZONTAL SPLIT CASE PUMPS
Type 6AE16 Size 6x8x16.75

SECTION 1240

1450 RPM

VELOCITY HEAD INCLUDED
TOTAL EYE AREA 37.69 SQ. IN.
SPHERE SIZE .70 IN.
PERFORMANCE AT 1.0 SP. GR.

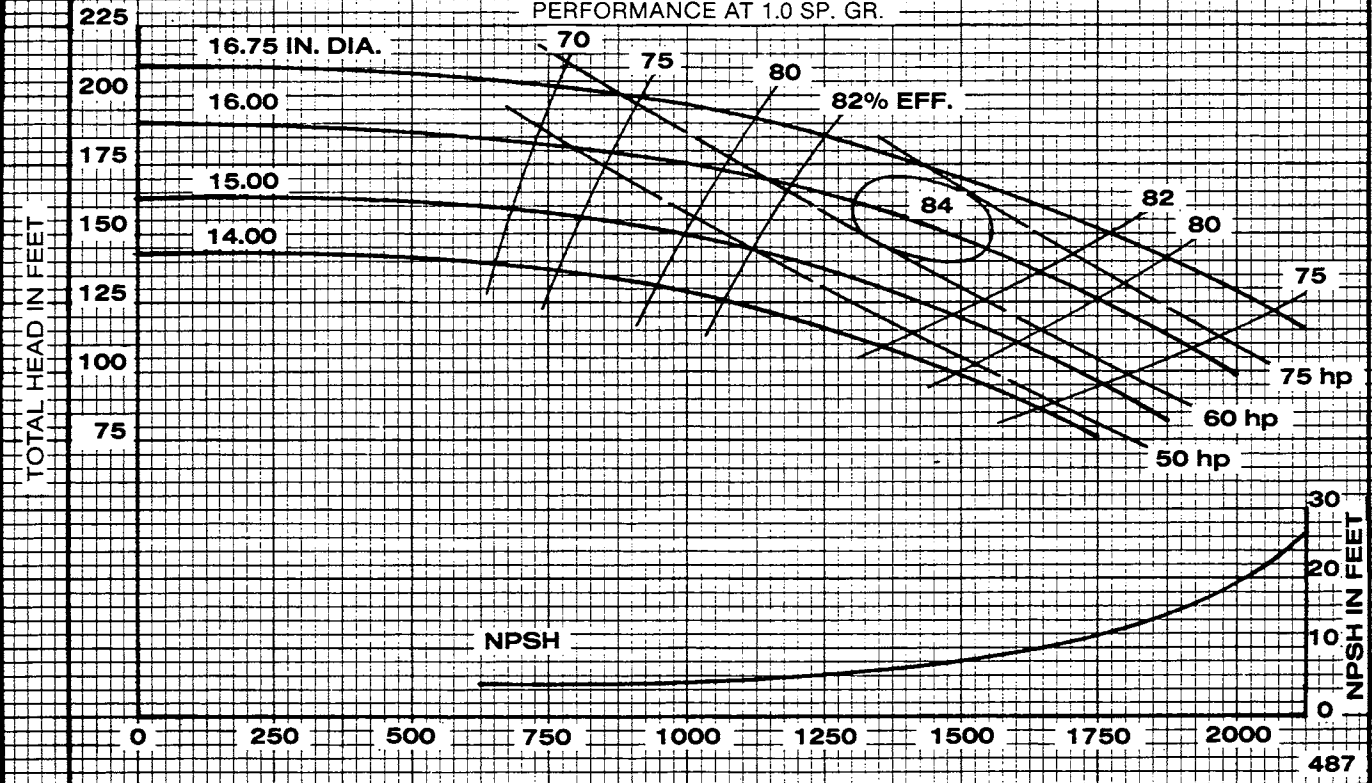

IMPELLER 2692932

U.S. GALLONS PER MINUTE

CURVE 3132054



Peerless Pump Company
Indianapolis, IN 46207-7026

HORIZONTAL SPLIT CASE PUMPS
Type 6AE16G Size 6 x 8 x 16.75

SECTION 1240

1450 RPM

VELOCITY HEAD INCLUDED
TOTAL EYE AREA 21.8 SQ. IN.
SPHERE SIZE .50 IN.
PERFORMANCE AT 1.0 SP. GR.

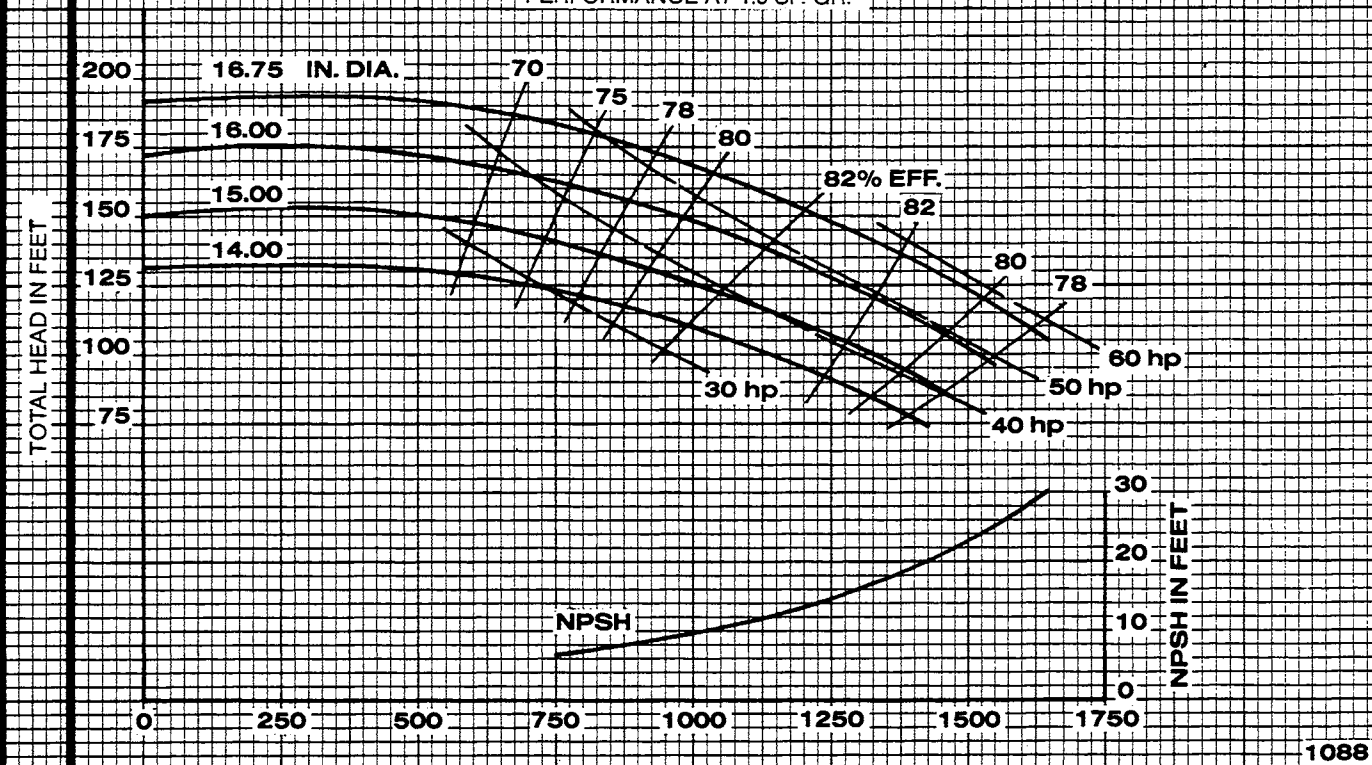

1088

IMPELLER **2692933**

U.S. GALLONS PER MINUTE

CURVE **3132109**



Peerless Pump Company
Indianapolis, IN 46207-7026

HORIZONTAL SPLIT CASE PUMPS
Type 6AE16V Size 6x8x17.00

SECTION 1240

1450 RPM

VELOCITY HEAD INCLUDED
TOTAL EYE AREA 24.6 SQ. IN.
SPHERE SIZE .56 IN.
PERFORMANCE AT 1.0 SP. GR.

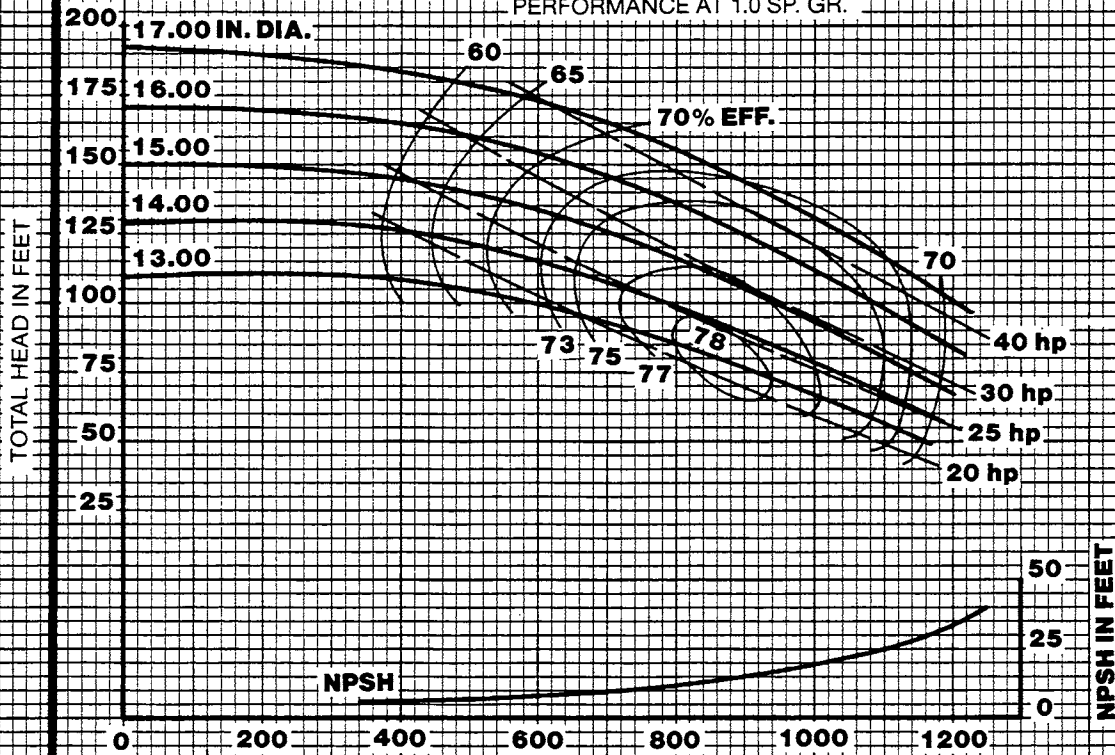

488

IMPELLER **2684461**

U.S. GALLONS PER MINUTE

CURVE **3132098**



Peerless Pump Company
Indianapolis, IN 46207-7026

HORIZONTAL SPLIT CASE PUMPS
Type 6AE16N Size 6x8x16.75

SECTION 1240

1450 RPM

VELOCITY HEAD INCLUDED
TOTAL EYE AREA 27.5 SQ. IN.
SPHERE SIZE .60 IN.
PERFORMANCE AT 1.0 SP. GR.

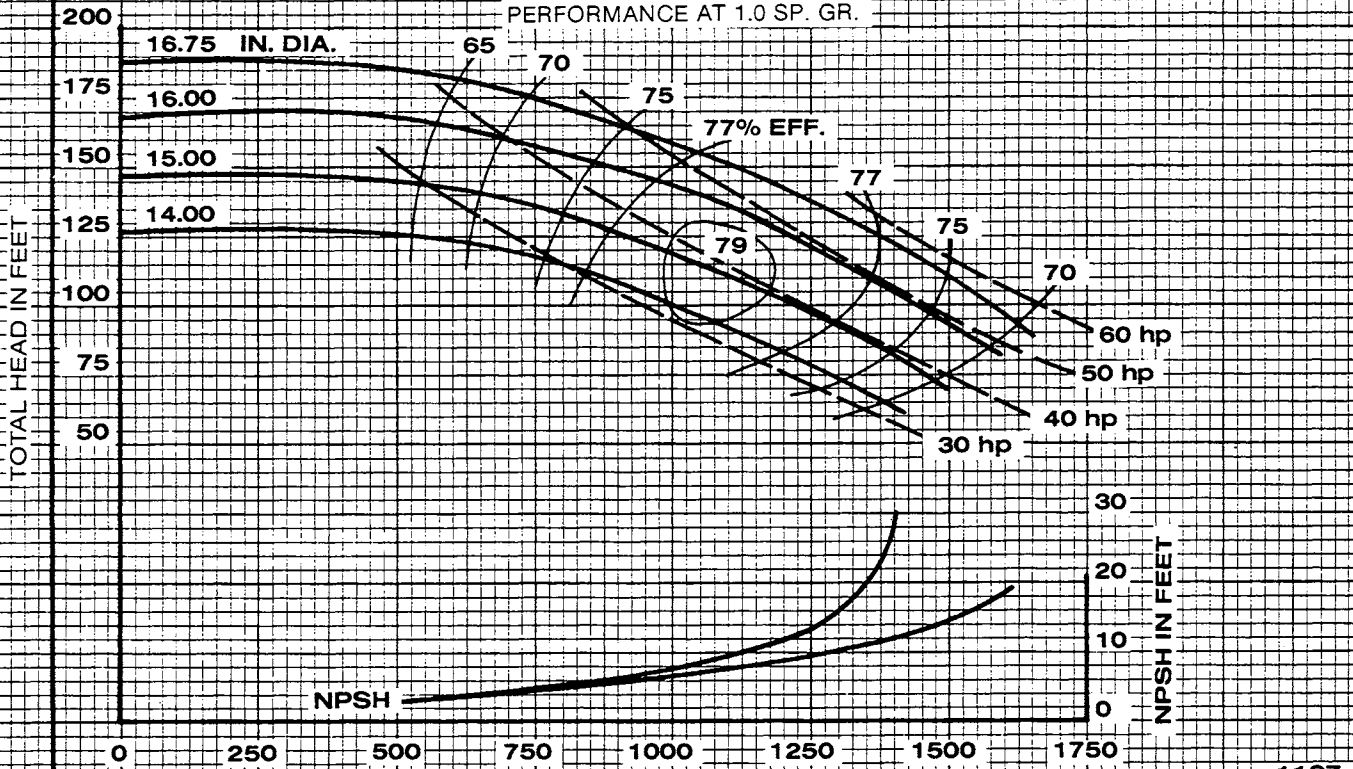

IMPELLER **2692931**

U.S. GALLONS PER MINUTE

CURVE **3132088**



Peerless Pump Company
Indianapolis, IN 46207-7026

HORIZONTAL SPLIT CASE PUMPS

Type 6AE18

Size 6 x 8 x 17.50

SECTION 1240

1460 RPM

VELOCITY HEAD INCLUDED
TOTAL EYE AREA 39.0 SQ. IN.
SPHERE SIZE .80 IN.
PERFORMANCE AT 1.0 SP. GR.

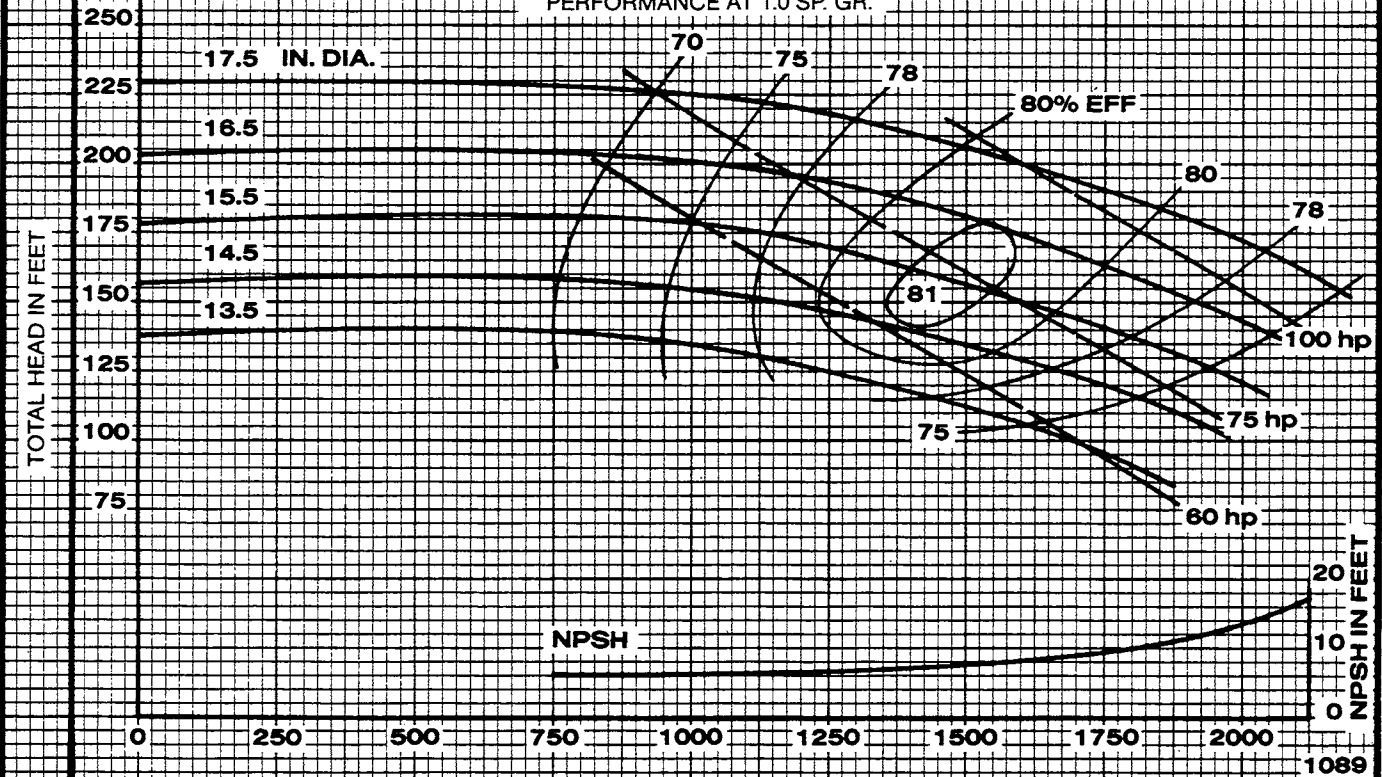

IMPELLER **2693457**

U.S. GALLONS PER MINUTE

CURVE **3132118**



Peerless Pump Company
Indianapolis, IN 46207-7026

HORIZONTAL SPLIT CASE PUMPS
Type 8AE12 Size 8x8x12.00

SECTION 1240

1450 RPM

VELOCITY HEAD INCLUDED
TOTAL EYE AREA 44.8 SQ. IN.
SPHERE SIZE 1.15 IN.
PERFORMANCE AT 1.0 SP. GR.

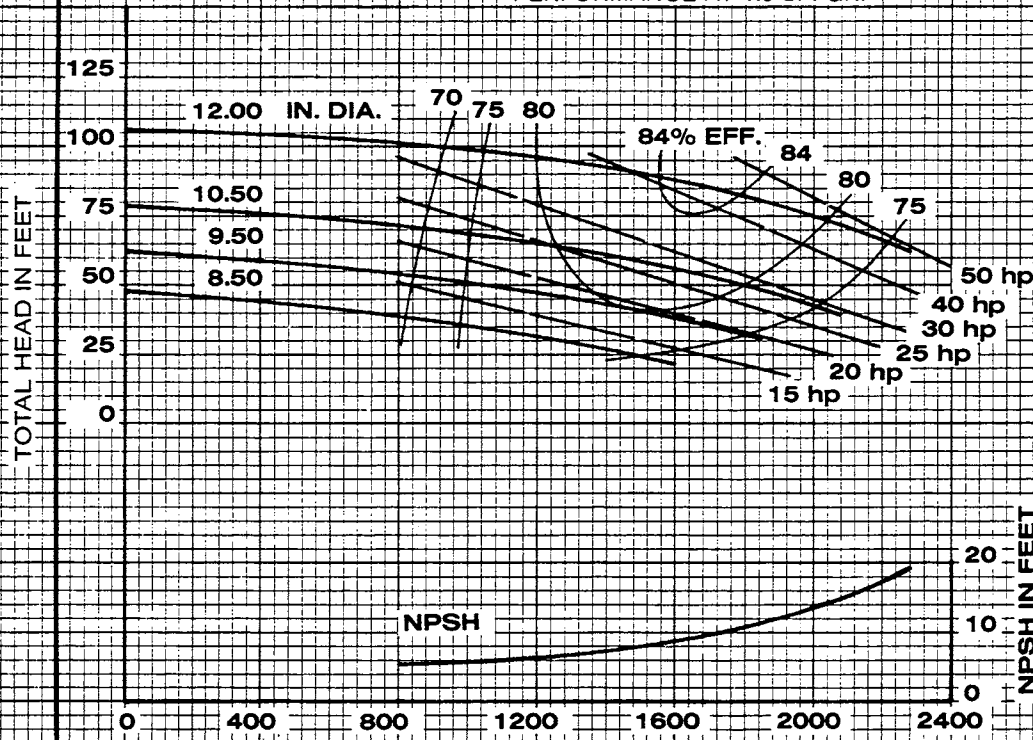

986

IMPELLER 2692806

U.S. GALLONS PER MINUTE

CURVE 3132018



Peerless Pump Company
Indianapolis, IN 46207-7026

HORIZONTAL SPLIT CASE PUMPS
Type 8AE13 Size 8x10x13.00

SECTION 1240

1450 RPM

VELOCITY HEAD INCLUDED
TOTAL EYE AREA 63.50 SQ. IN.
SPHERE SIZE .85 IN.
PERFORMANCE AT 1.0 SP. GR.

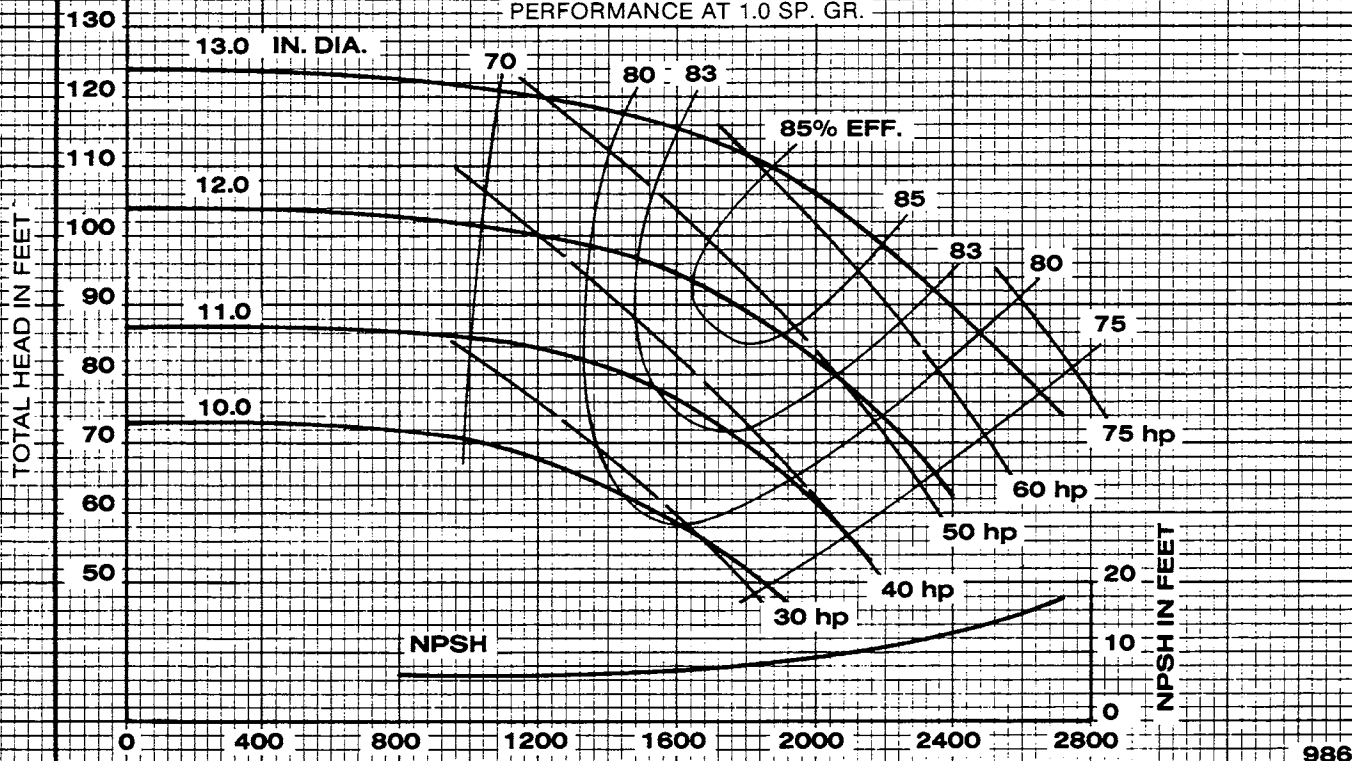

IMPELLER 2693445

U.S. GALLONS PER MINUTE

CURVE 3132024



Peerless Pump Company
Indianapolis, IN 46207-7026

HORIZONTAL SPLIT CASE PUMPS
Type 8AE15 Size 8 x 10 x 15.50

SECTION 1240

1450 RPM

VELOCITY HEAD INCLUDED
TOTAL EYE AREA 74.50 SQ. IN.
SPHERE SIZE 1.38 IN.
PERFORMANCE AT 1.0 SP. GR.

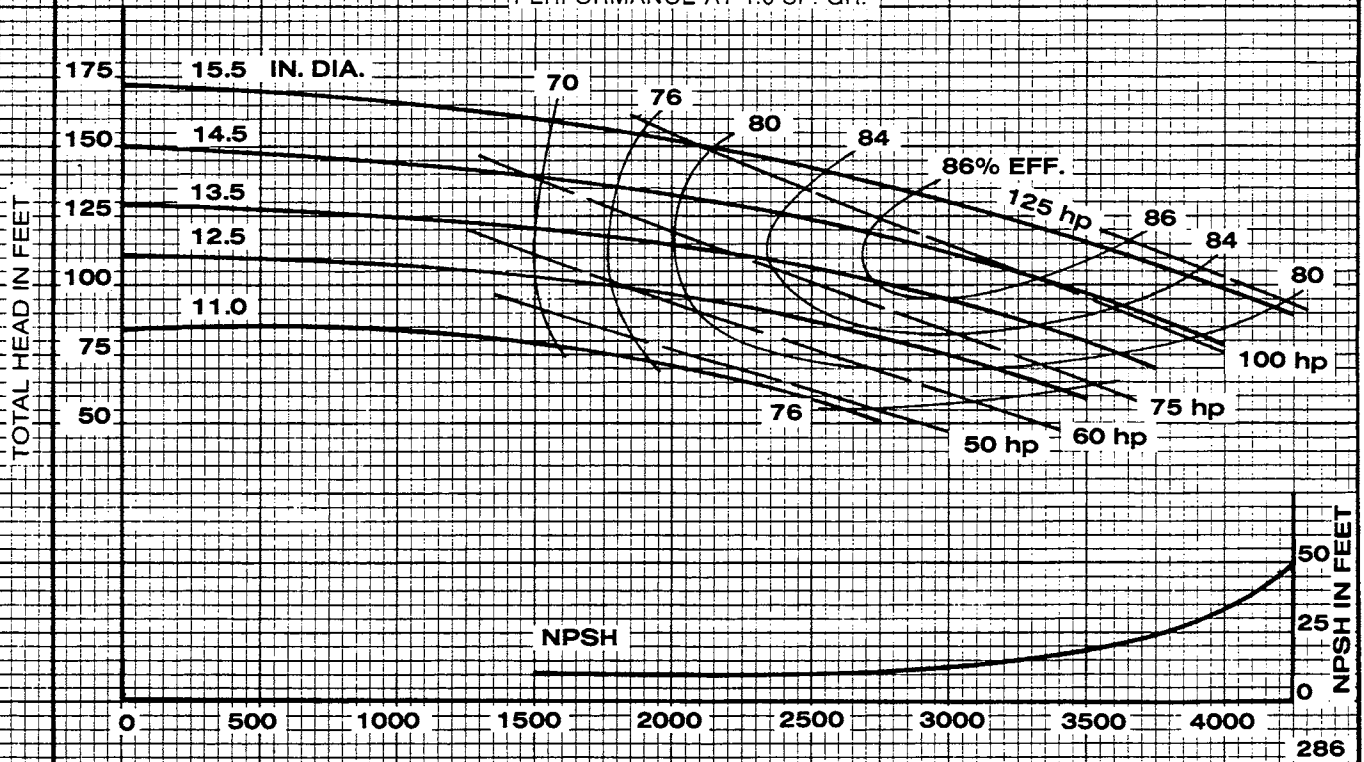

IMPELLER **2692769**

U.S. GALLONS PER MINUTE

CURVE **3112027r**



Peerless Pump Company
Indianapolis, IN 46207-7026

HORIZONTAL SPLIT CASE PUMPS
Type 8AE15G Size 8x10x15.50

SECTION 1240

1450 RPM

VELOCITY HEAD INCLUDED
TOTAL EYE AREA 51.0 SQ. IN.
SPHERE SIZE .74 IN.
PERFORMANCE AT 1.0 SP. GR.

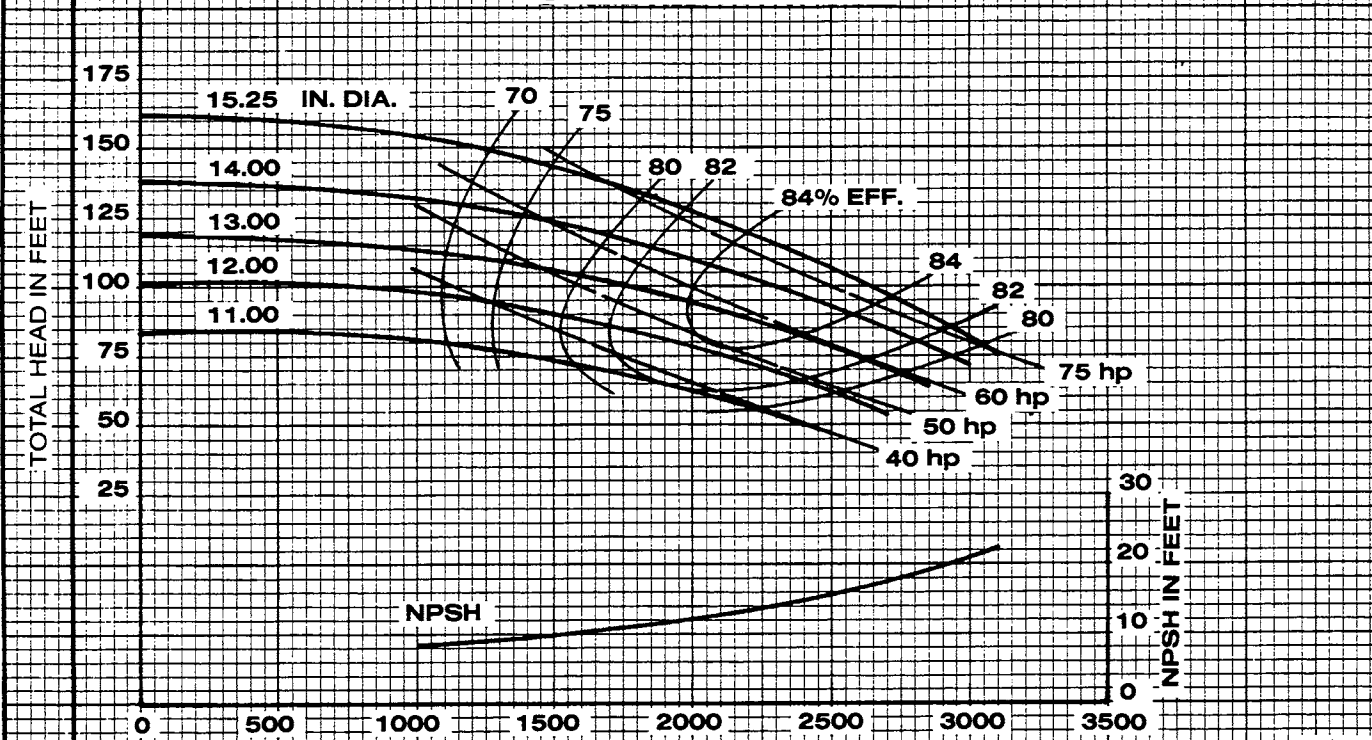

1087

IMPELLER **2694320**

U.S. GALLONS PER MINUTE

CURVE **3132082**



Peerless Pump Company
Indianapolis, IN 46207-7026

HORIZONTAL SPLIT CASE PUMPS
Type 8AE17A Size 8 x 10 x 17

SECTION 1240

1460 RPM

VELOCITY HEAD INCLUDED
TOTAL EYE AREA 65.0 SQ. IN.
SPHERE SIZE .95 IN.
PERFORMANCE AT 1.0 SP. GR.

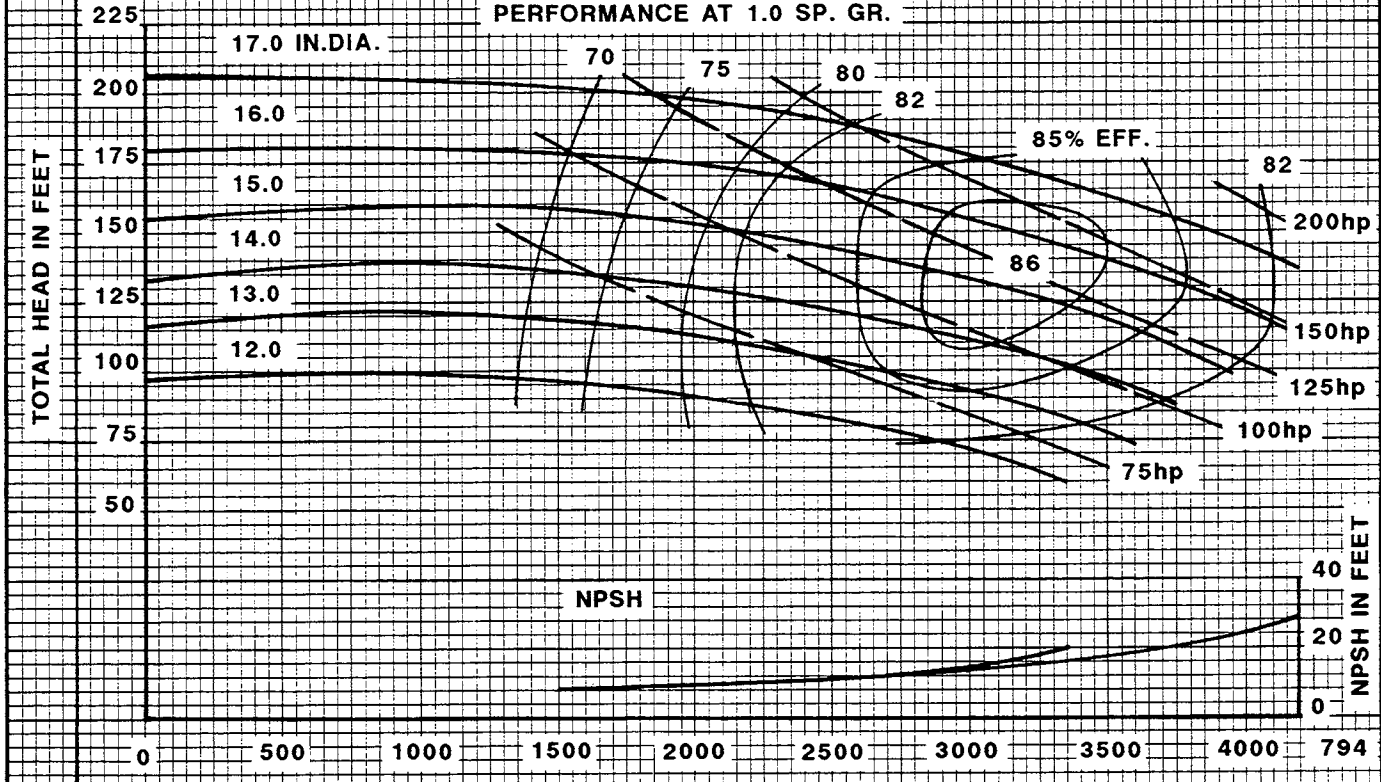

IMPELLER 2693259

U.S. GALLONS PER MINUTE

CURVE 3132140



Peerless Pump Company
Indianapolis, IN 46207-7026

HORIZONTAL SPLIT CASE PUMPS
Type 8AE17Q Size 8 x 10 x 17

SECTION 1240

1460 RPM

VELOCITY HEAD INCLUDED
TOTAL EYE AREA 55.8 SQ. IN.
SPHERE SIZE .94 IN.
PERFORMANCE AT 1.0 SP. GR.

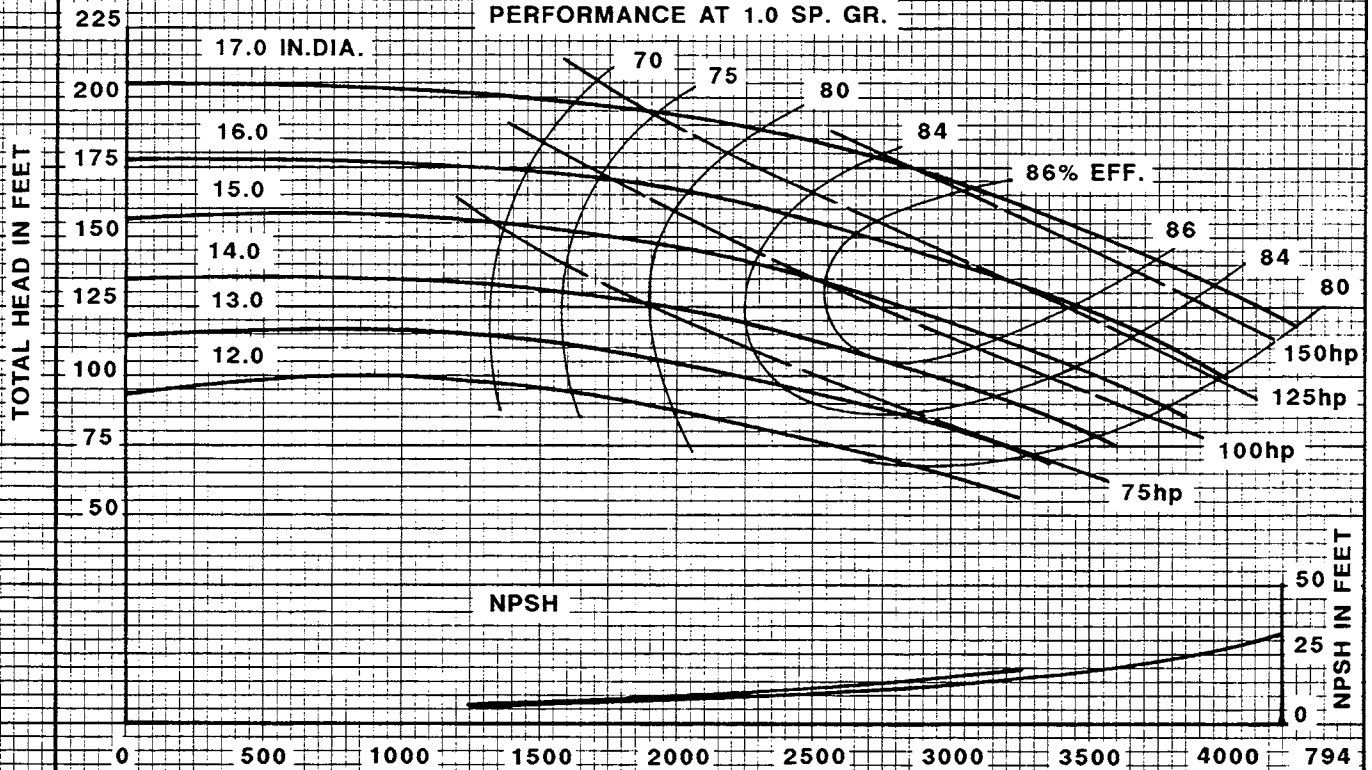

IMPELLER 2693257

U.S. GALLONS PER MINUTE

CURVE 3132143



Peerless Pump Company
Indianapolis, IN 46207-7026

HORIZONTAL SPLIT CASE PUMPS
Type 8AE20 Size 8x10x19.00

SECTION 1240

1465 RPM

VELOCITY HEAD INCLUDED
TOTAL EYE AREA 48.5 SQ. IN.
SPHERE SIZE .75 IN.
PERFORMANCE AT 1.0 SP. GR.

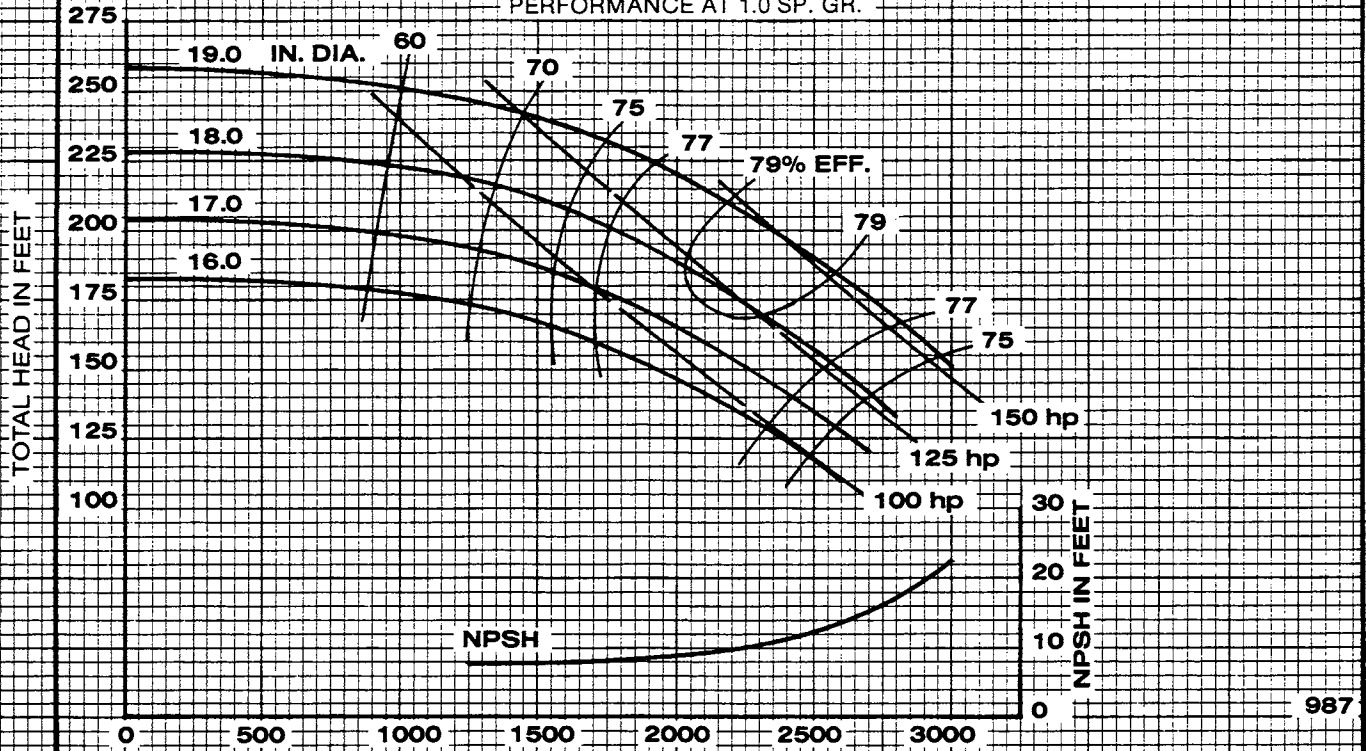

IMPELLER 2693333

U.S. GALLONS PER MINUTE

CURVE 3132070

987



Peerless Pump Company
Indianapolis, IN 46207-7026

HORIZONTAL SPLIT CASE PUMPS
Type 8AE20G Size 8x10x20.00

SECTION 1240

1465 RPM

VELOCITY HEAD INCLUDED
TOTAL EYE AREA 59.2 SQ. IN.
SPHERE SIZE .75 IN.
PERFORMANCE AT 1.0 SP. GR.

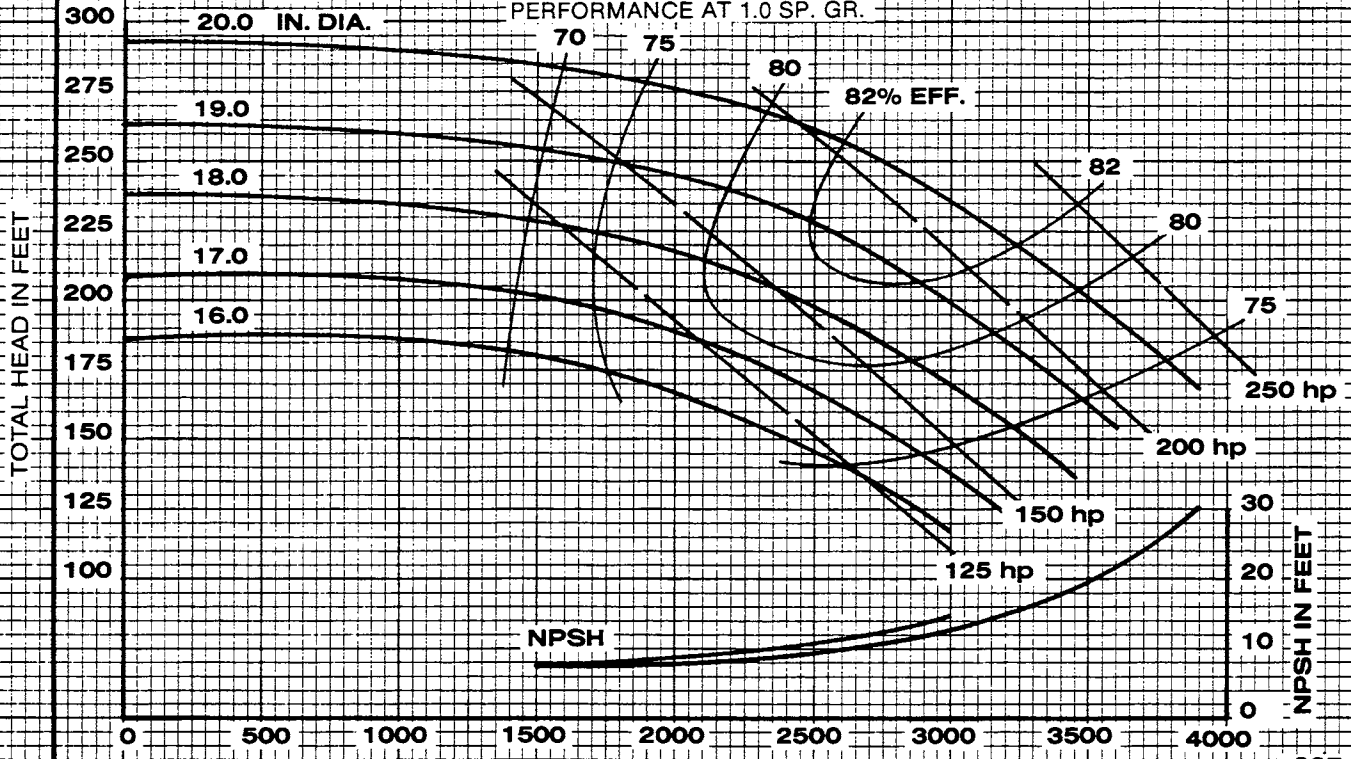

IMPELLER **2693332**

U.S. GALLONS PER MINUTE

CURVE **3132076**



Peerless Pump Company
Indianapolis, IN 46207-7026

HORIZONTAL SPLIT CASE PUMPS
Type 10AE12 Size 10 x 10 x 12.00

SECTION 1240

1450 RPM

VELOCITY HEAD INCLUDED
TOTAL EYE AREA 64.4 SQ. IN.
SPHERE SIZE .77 IN.
PERFORMANCE AT 1.0 SP. GR.

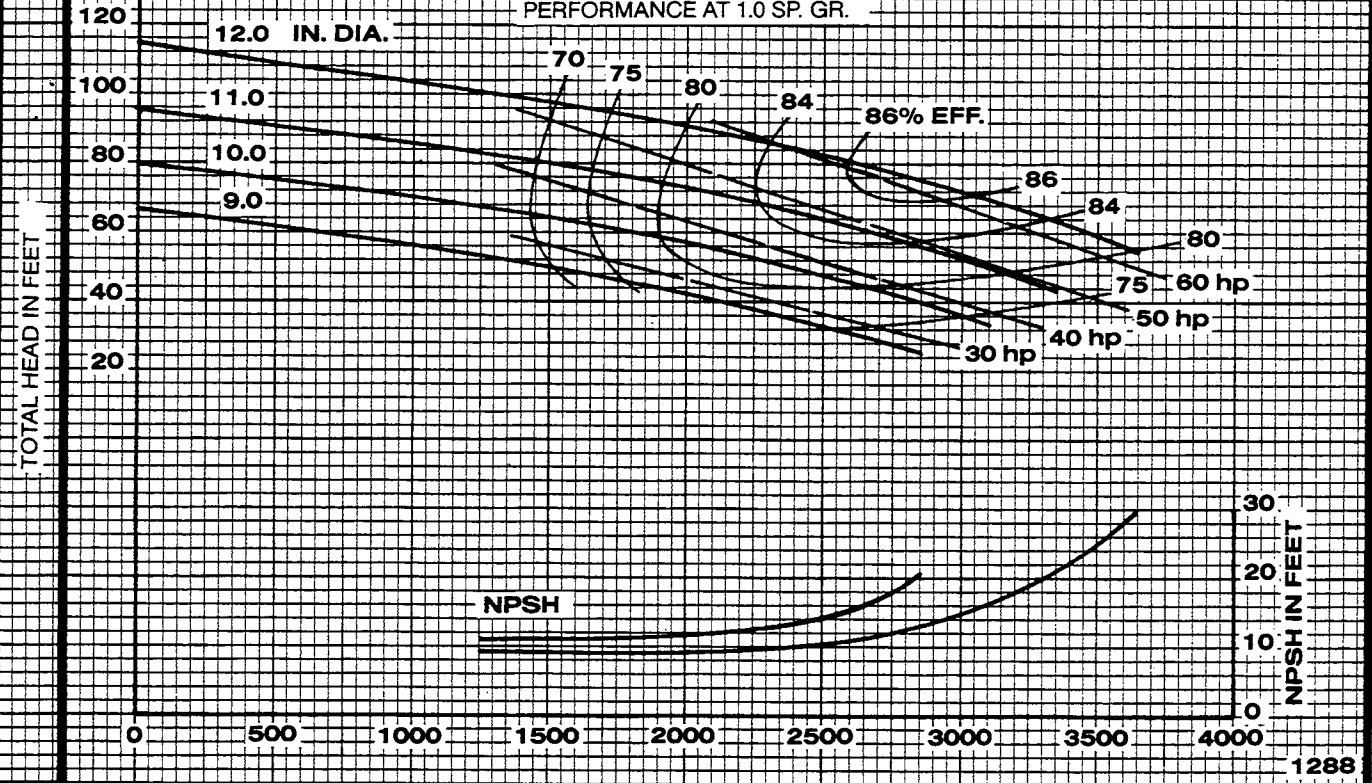

IMPELLER 2694126

U.S. GALLONS PER MINUTE

CURVE 3132112



Peerless Pump Company
Indianapolis, IN 46207-7026

HORIZONTAL SPLIT CASE PUMPS
Type 10AE14A Size 10 x 12 x 14

SECTION 1240

VELOCITY HEAD INCLUDED
TOTAL EYE AREA 90.0 SQ.IN.
SPHERE SIZE .94 IN.
PERFORMANCE AT 1.0 SP.GR.

1465 RPM

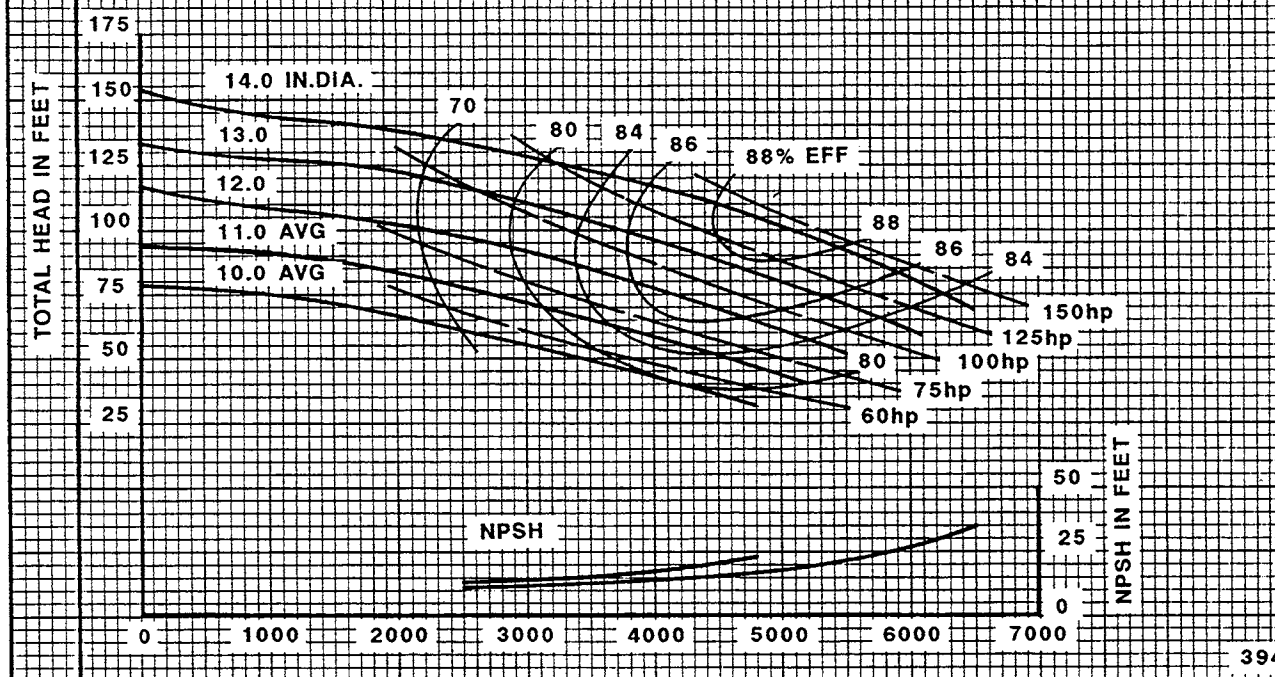

IMPELLER 2693193

U.S. GALLONS PER MINUTE

CURVE 3132136

394



Peerless Pump Company
Indianapolis, IN 46207-7026

HORIZONTAL SPLIT CASE PUMPS

Type 10AE14J

Size 10 x 12 x 14

SECTION 1240

VELOCITY HEAD INCLUDED
TOTAL EYE AREA 80.0 SQ.IN.
SPHERE SIZE .94 IN.
PERFORMANCE AT 1.0 SP.GR.

1465 RPM

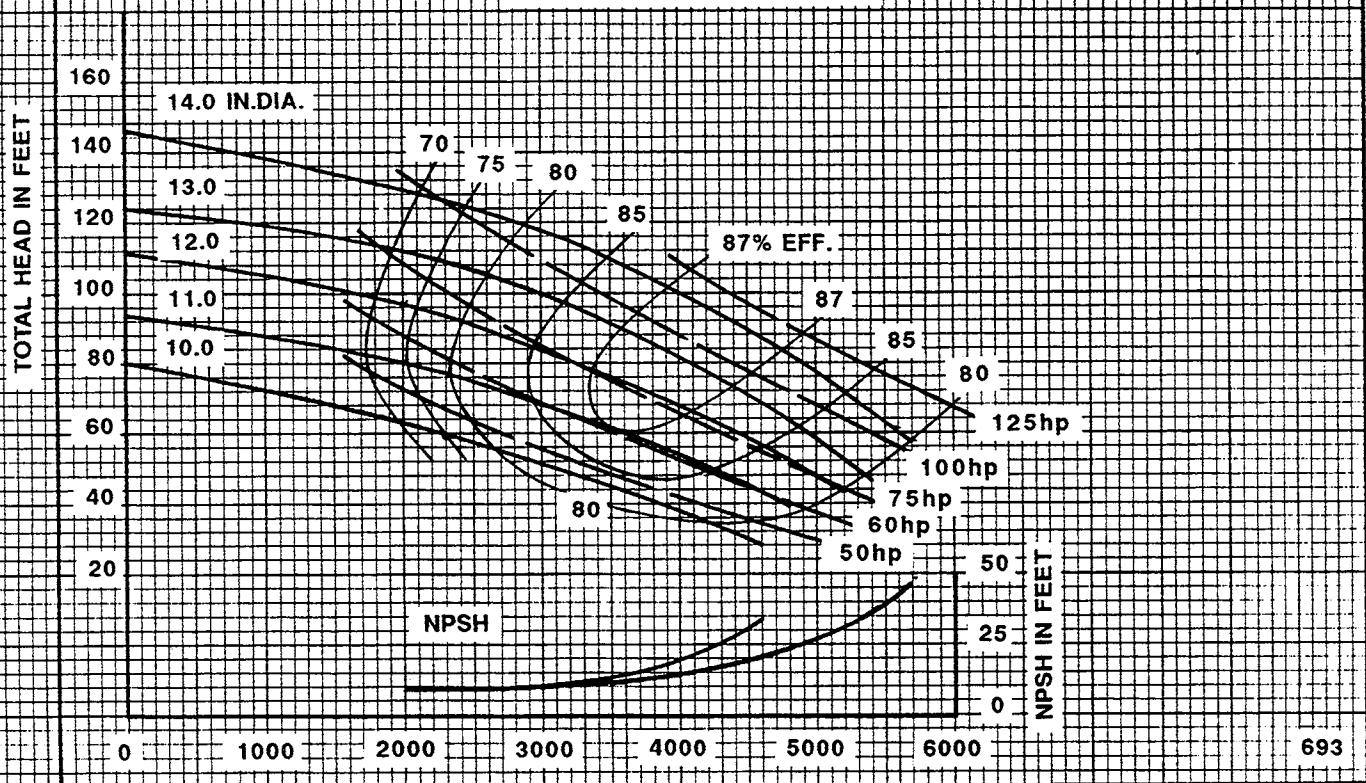

IMPELLER 2693192

U.S. GALLONS PER MINUTE

CURVE 3132132

693



Peerless Pump Company
Indianapolis, IN 46207-7026

HORIZONTAL SPLIT CASE PUMPS
Type 10AE16 Size 10 x 12 x 16

SECTION 1240

1465 RPM

VELOCITY HEAD INCLUDED
TOTAL EYE AREA 100.0 SQ.IN.
SPHERE SIZE 1.12 IN.
PERFORMANCE AT 1.0 SP.GR.

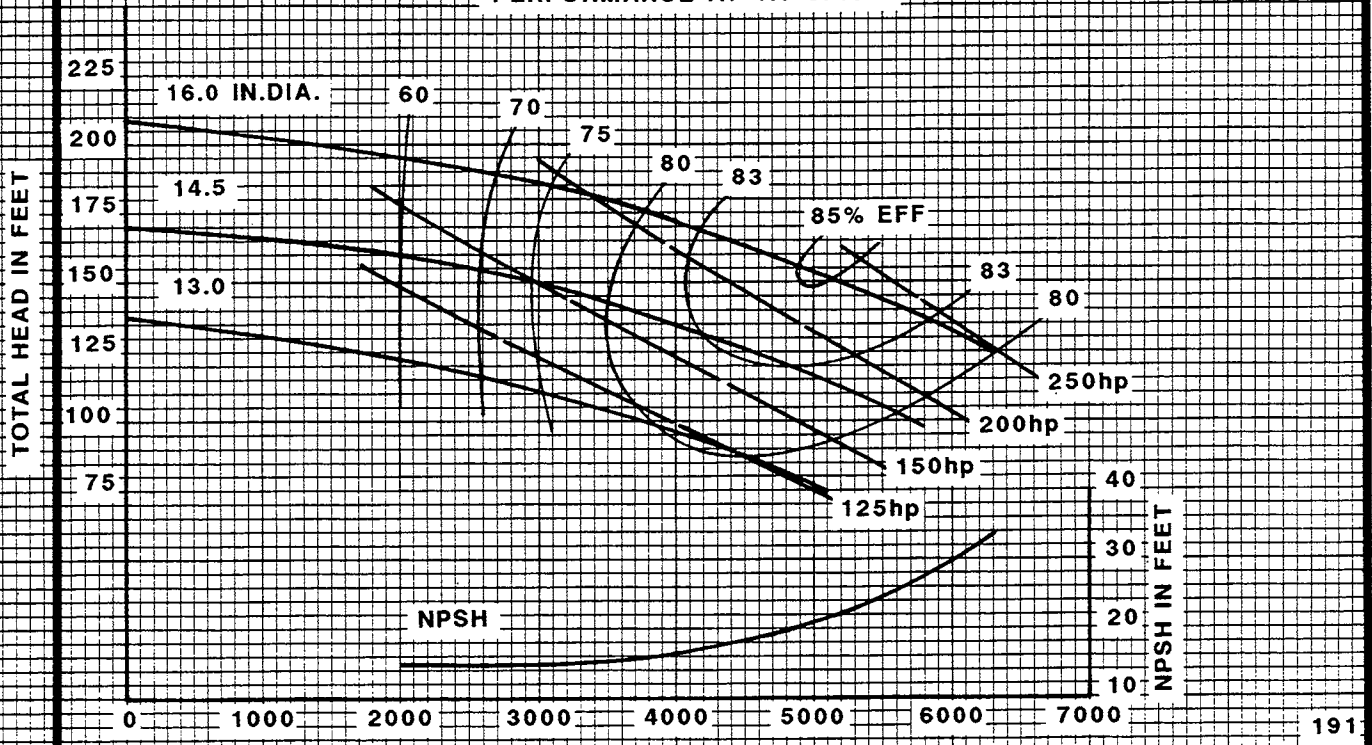

IMPELLER 2692881

U.S. GALLONS PER MINUTE

CURVE 3132124



Peerless Pump Company
Indianapolis, IN 46207-7026

HORIZONTAL SPLIT CASE PUMPS
Type 10AE20 Size 10 x 12 x 20

SECTION 1240

1470 RPM

VELOCITY HEAD INCLUDED
TOTAL EYE AREA 79.0 SQ. IN.
SPHERE SIZE .95 IN.
PERFORMANCE AT 1.0 SP. GR.

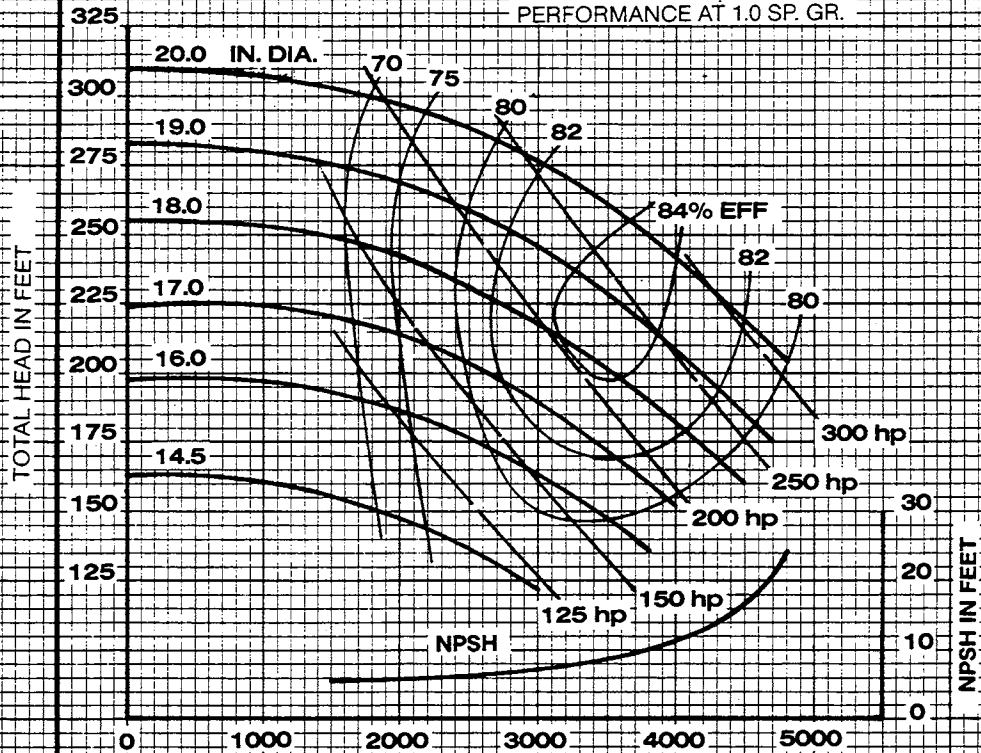

NPSH IN FEET

1087

IMPELLER 2693541

U.S. GALLONS PER MINUTE

CURVE 3132079



Peerless Pump Company
Indianapolis, IN 46207-7026

HORIZONTAL SPLIT CASE PUMPS
Type 2AE11 Size 2x3x10.38

SECTION 1240

1450 RPM

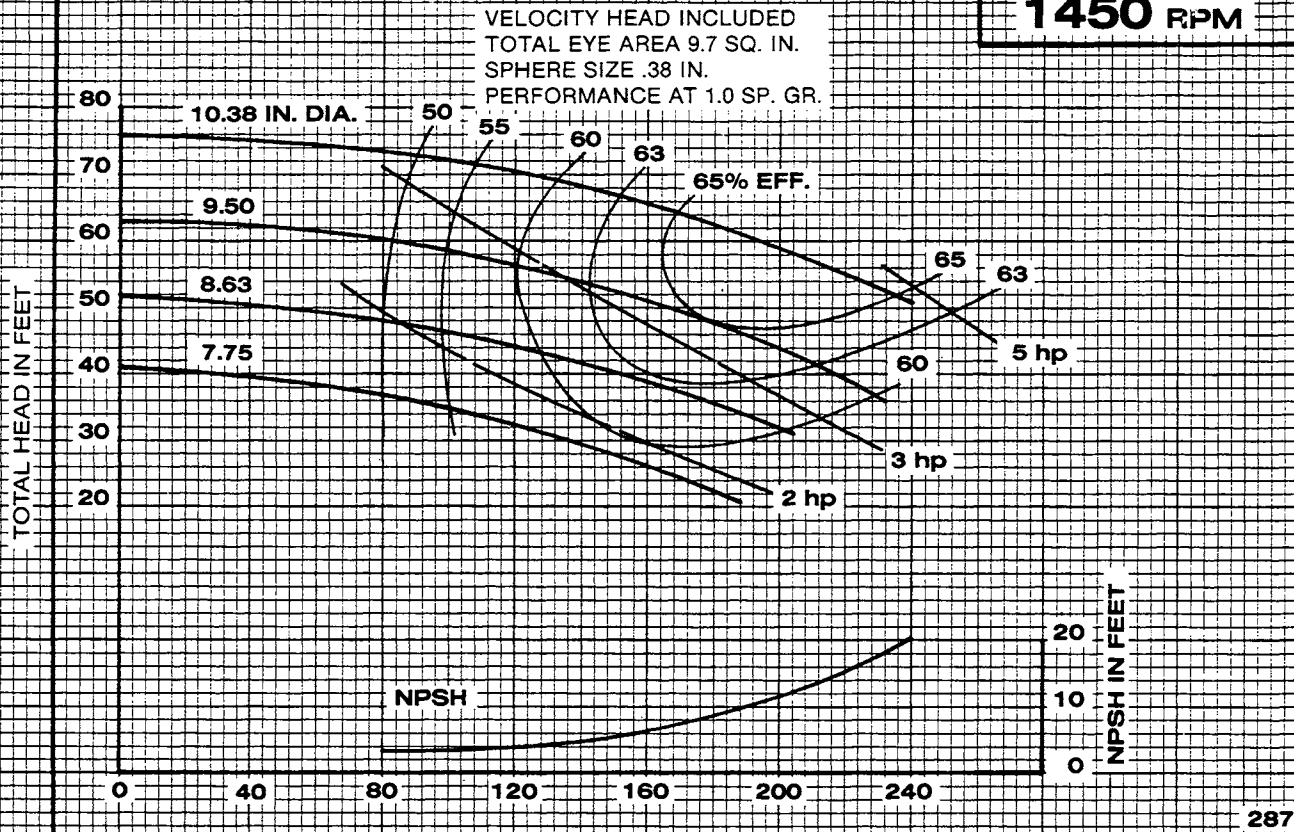

IMPELLER 2693522

U.S. GALLONS PER MINUTE

CURVE 3132043

2900 RPM

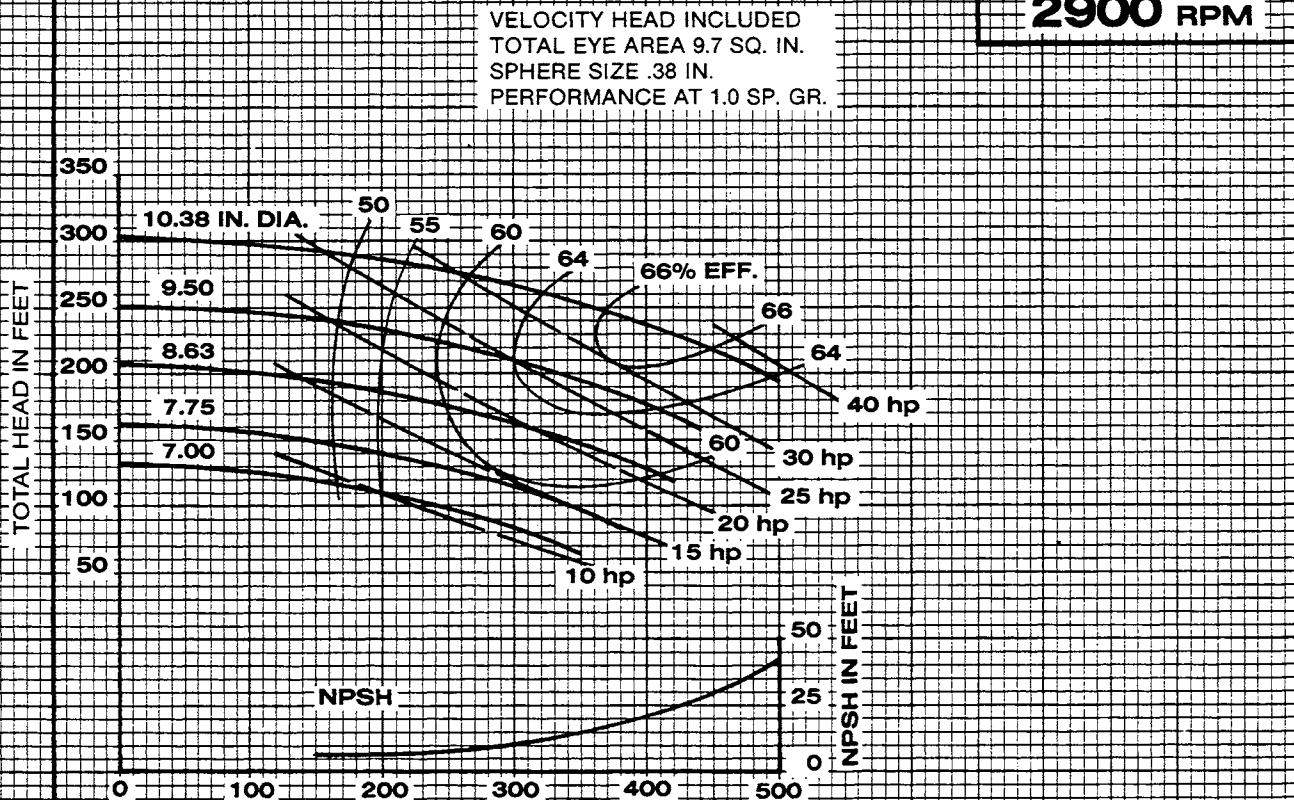

IMPELLER 2693522

U.S. GALLONS PER MINUTE

CURVE 3132041



Peerless Pump Company
Indianapolis, IN 46207-7026

HORIZONTAL SPLIT CASE PUMPS
Type 3AE9 Size 3x4x9.00

SECTION 1240

2935 RPM

VELOCITY HEAD INCLUDED
TOTAL EYE AREA 12.2 SQ. IN.
SPHERE SIZE .56 IN.
PERFORMANCE AT 1.0 SP. GR.

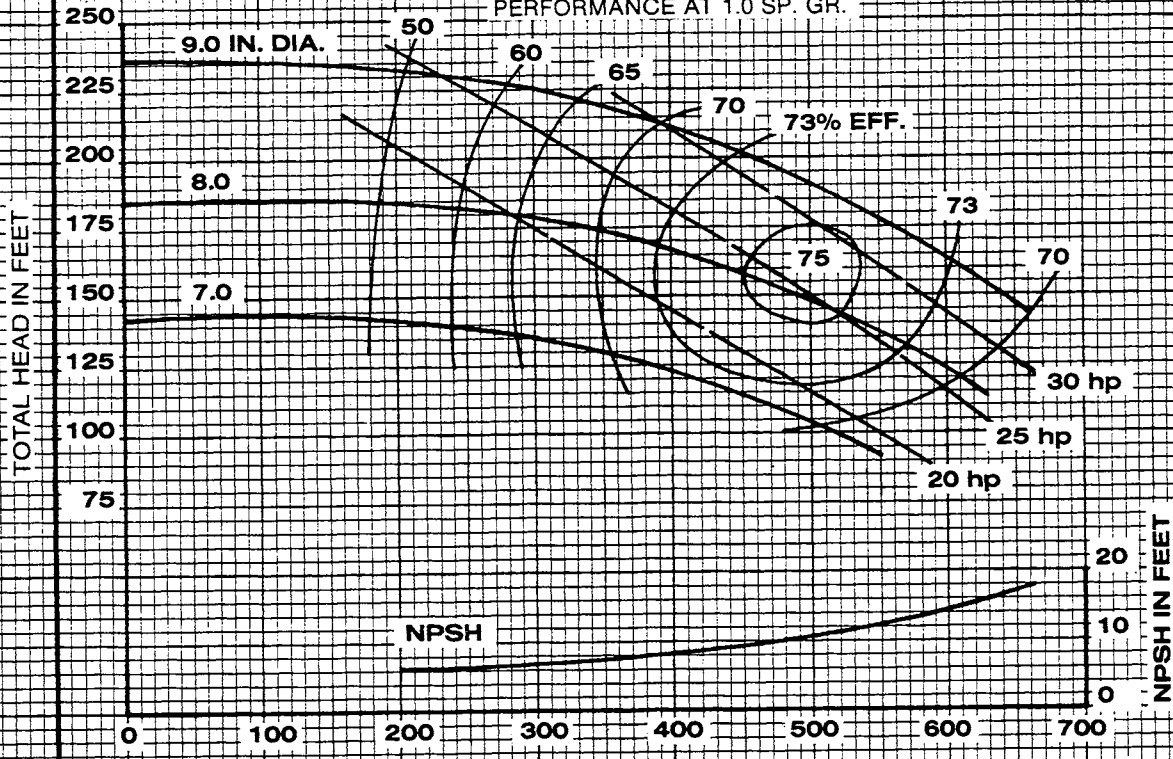

587

IMPELLER **2693450**

U.S. GALLONS PER MINUTE

CURVE **3132064**



Peerless Pump Company
Indianapolis, IN 46207-7026

HORIZONTAL SPLIT CASE PUMPS
Type 3AE9G Size 3x4x9.00

SECTION 1240

2935 RPM

VELOCITY HEAD INCLUDED
TOTAL EYE AREA 12.2 SQ. IN.
SPHERE SIZE .56 IN.
PERFORMANCE AT 1.0 SP. GR.

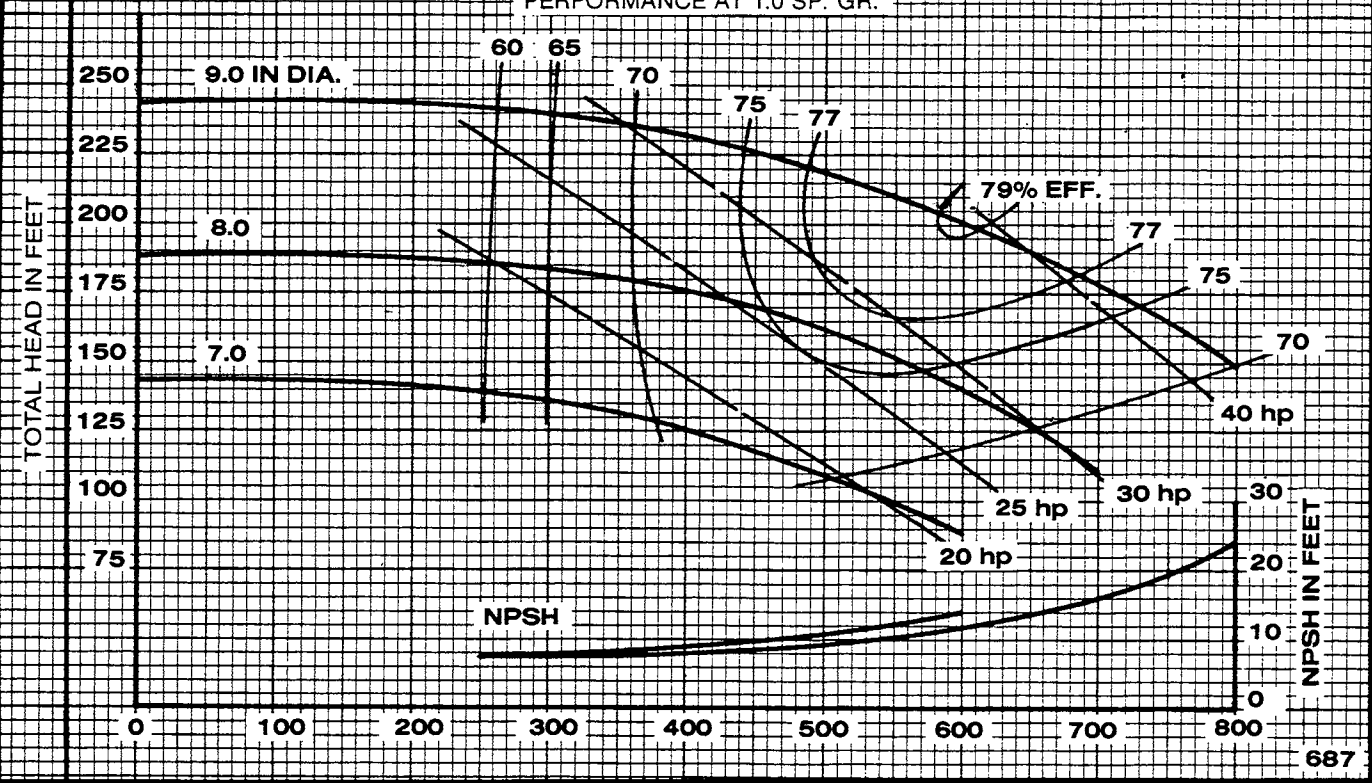

IMPELLER **2693451**

U.S. GALLONS PER MINUTE

CURVE **3132061**

687



Peerless Pump Company
Indianapolis, IN 46207-7026

HORIZONTAL SPLIT CASE PUMPS
Type 3AE14 Size 3x4x14.00

SECTION 1240

1450 RPM

VELOCITY HEAD INCLUDED
TOTAL EYE AREA 14.9 SQ. IN.
SPHERE SIZE .40 IN.
PERFORMANCE AT 1.0 SP. GR.

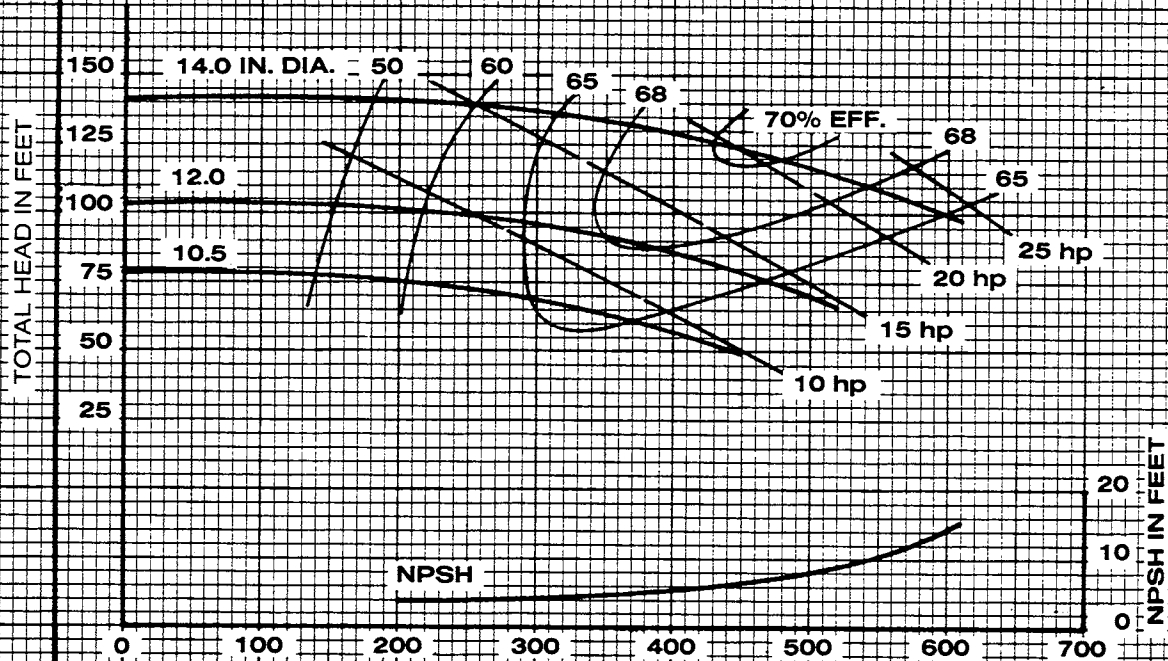

287

IMPELLER 2693509

U.S. GALLONS PER MINUTE

CURVE 3132048



Peerless Pump Company
Indianapolis, IN 46207-7026

HORIZONTAL SPLIT CASE PUMPS
Type 3AE14G Size 3 x 4 x 13

SECTION 1240

1450 RPM

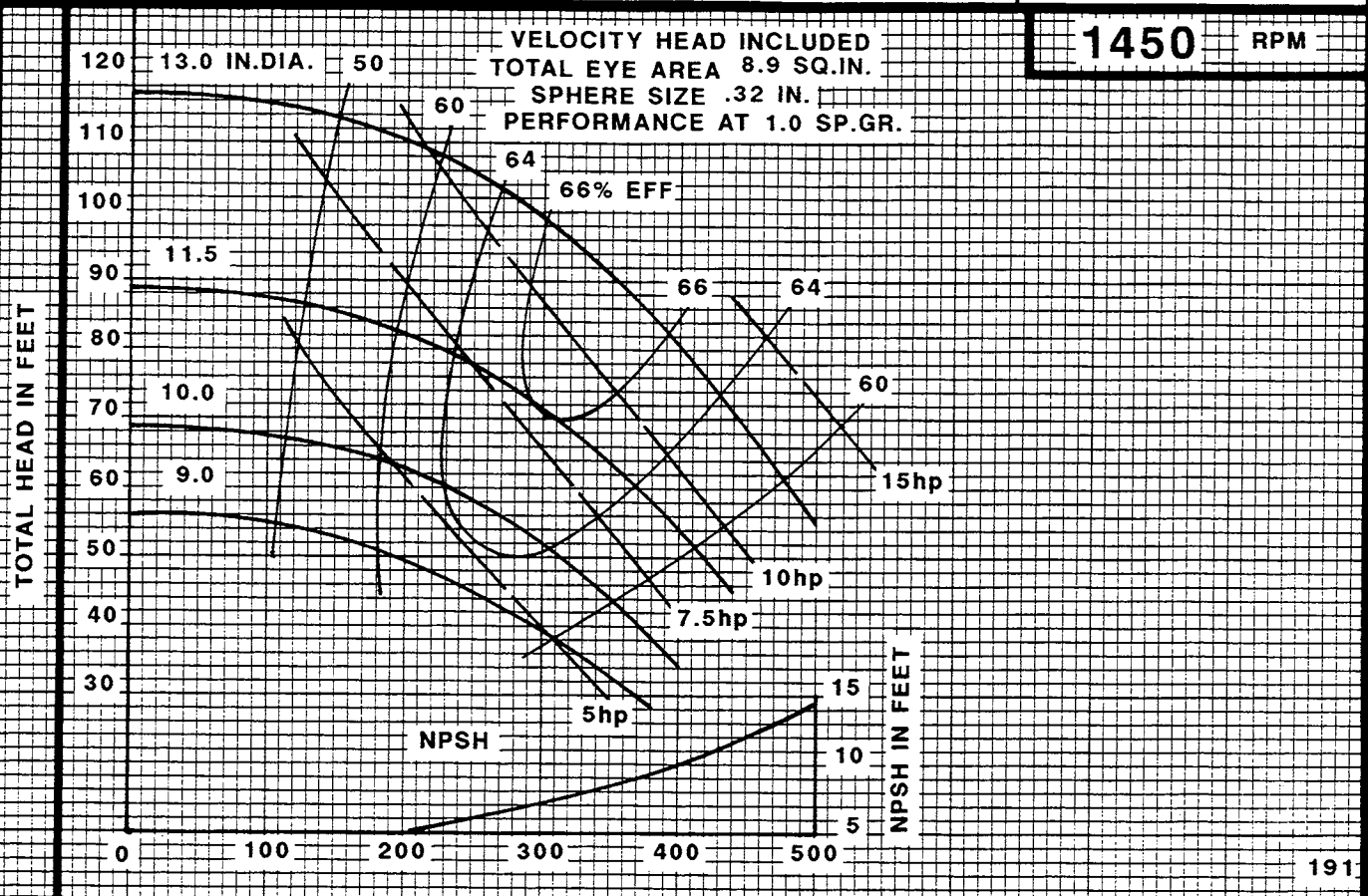

IMPELLER 2694939

U.S. GALLONS PER MINUTE

CURVE 3132122



Peerless Pump Company
Indianapolis, IN 46207-7026

HORIZONTAL SPLIT CASE PUMPS
Type 4AE10 Size 4 x 5 x 10.00

SECTION 1240

1450 RPM

VELOCITY HEAD INCLUDED
TOTAL EYE AREA 18.1 SQ. IN.
SPHERE SIZE .56 IN.
PERFORMANCE AT 1.0 SP. GR.

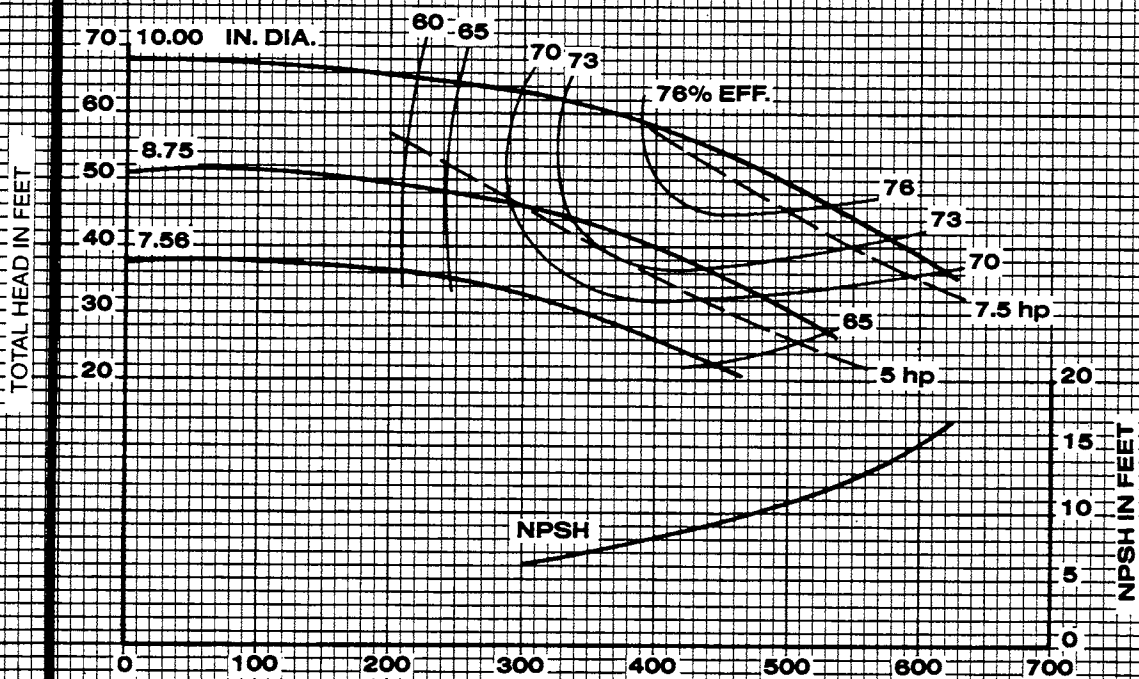

788

IMPELLER 2693319

U.S. GALLONS PER MINUTE

CURVE 3132104

2950 RPM

VELOCITY HEAD INCLUDED
TOTAL EYE AREA 18.1 SQ. IN.
SPHERE SIZE .56 IN.
PERFORMANCE AT 1.0 SP. GR.

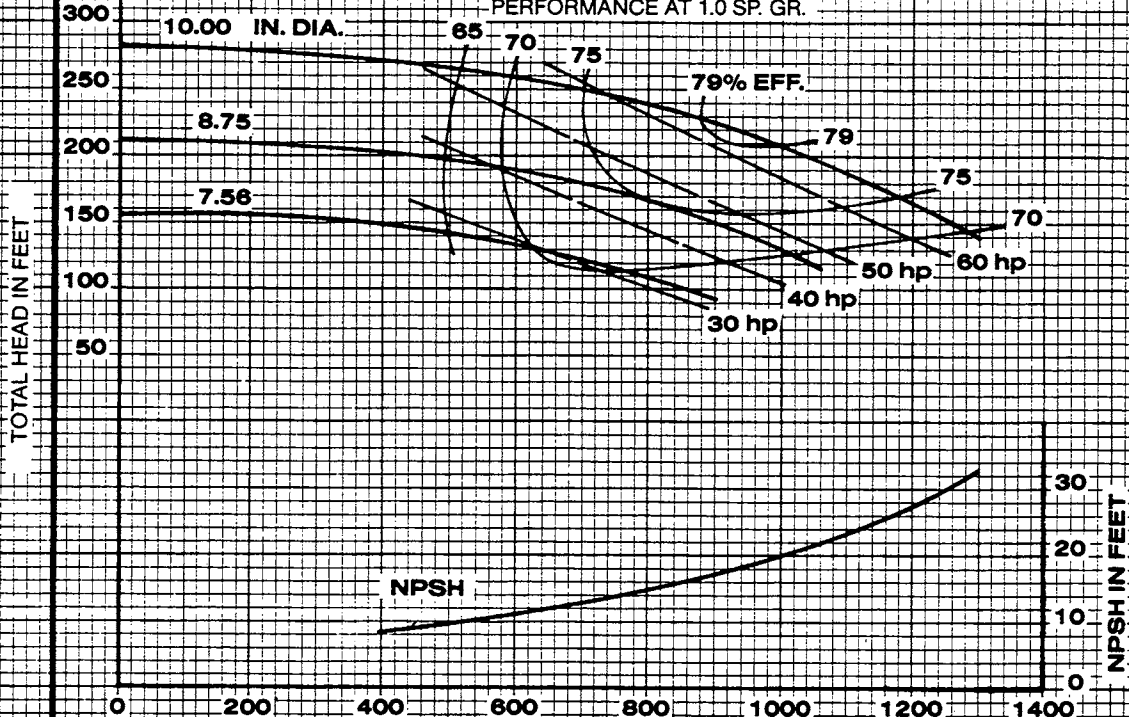

688

IMPELLER 2693319

U.S. GALLONS PER MINUTE

CURVE 3132011



Peerless Pump Company
Indianapolis, IN 46207-7026

HORIZONTAL SPLIT CASE PUMPS

Type 4AE10G

Size 4 x 5 x 9

SECTION 1240

2935 RPM

VELOCITY HEAD INCLUDED
TOTAL EYE AREA 12.2 SQ. IN.
SPHERE SIZE .56 IN.
PERFORMANCE AT 1.0 SP. GR.

TOTAL HEAD IN FEET

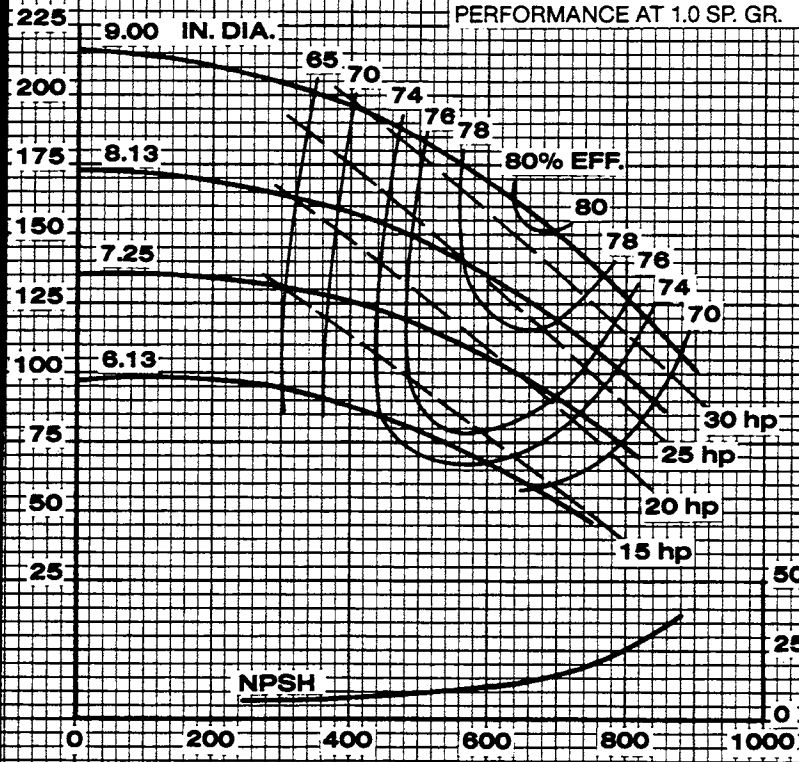

NPSH IN FEET

688

IMPELLER 2693450

U.S. GALLONS PER MINUTE

CURVE 3132091



Peerless Pump Company
Indianapolis, IN 46207-7026

HORIZONTAL SPLIT CASE PUMPS
Type 4AE11 Size 4x5x11.25

SECTION 1240

1450 RPM

VELOCITY HEAD INCLUDED
TOTAL EYE AREA 28.50 SQ. IN.
SPHERE SIZE .72 IN.
PERFORMANCE AT 1.0 SP. GR.

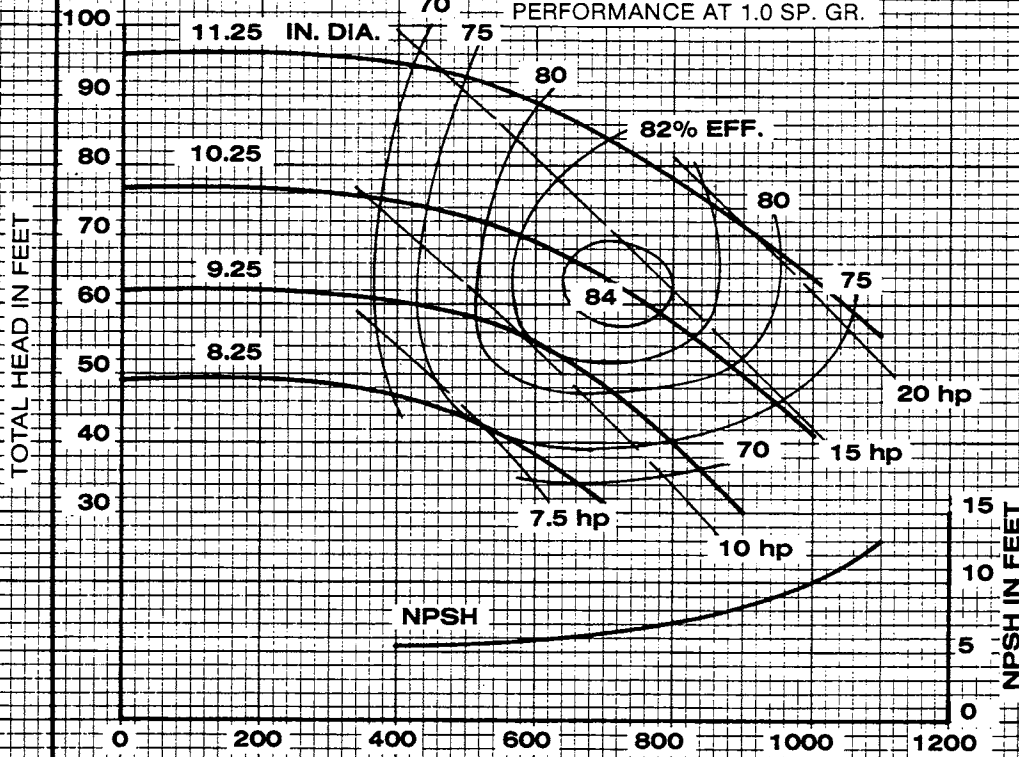

586

IMPELLER **2692930**

U.S. GALLONS PER MINUTE

CURVE **3132004**



Peerless Pump Company
Indianapolis, IN 46207-7026

HORIZONTAL SPLIT CASE PUMPS
Type 4AE11G Size 4x5x11.25

SECTION 1240

1450 RPM

VELOCITY HEAD INCLUDED
TOTAL EYE AREA 18.04 SQ. IN.
SPHERE SIZE .62 IN.
PERFORMANCE AT 1.0 SP. GR.

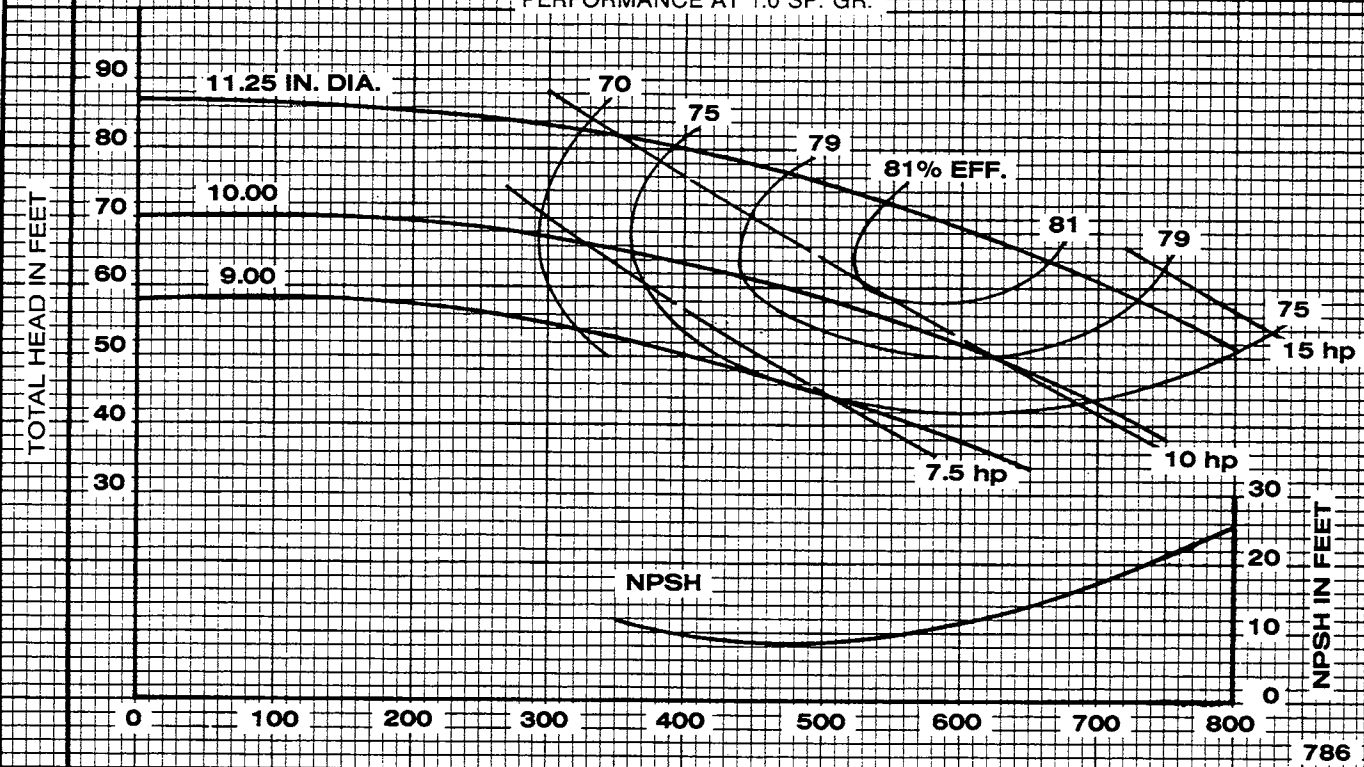

786

IMPELLER **2693667**

U.S. GALLONS PER MINUTE

CURVE **3132014**



Peerless Pump Company
Indianapolis, IN 46207-7026

HORIZONTAL SPLIT CASE PUMPS
Type 4AE12 Size 4x5x12.12

SECTION 1240

1450 RPM

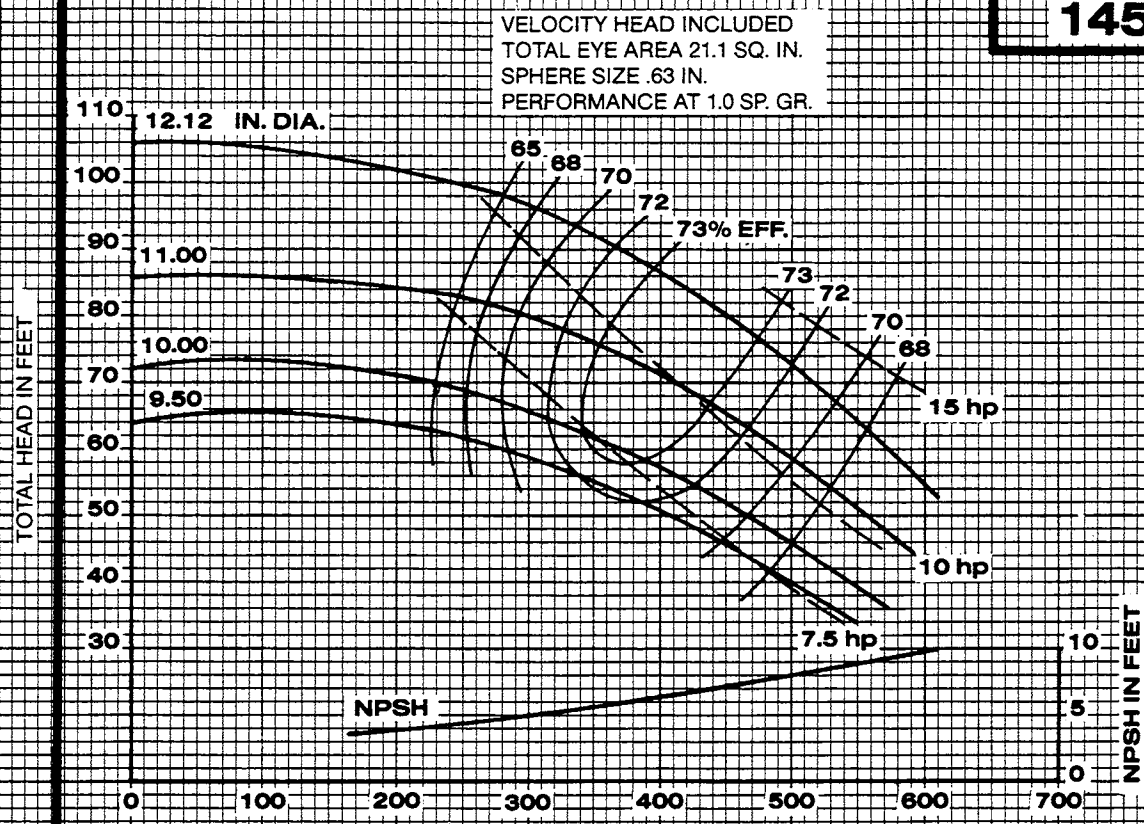

IMPELLER **2692300**

U.S. GALLONS PER MINUTE

CURVE **3132103**

2950 RPM

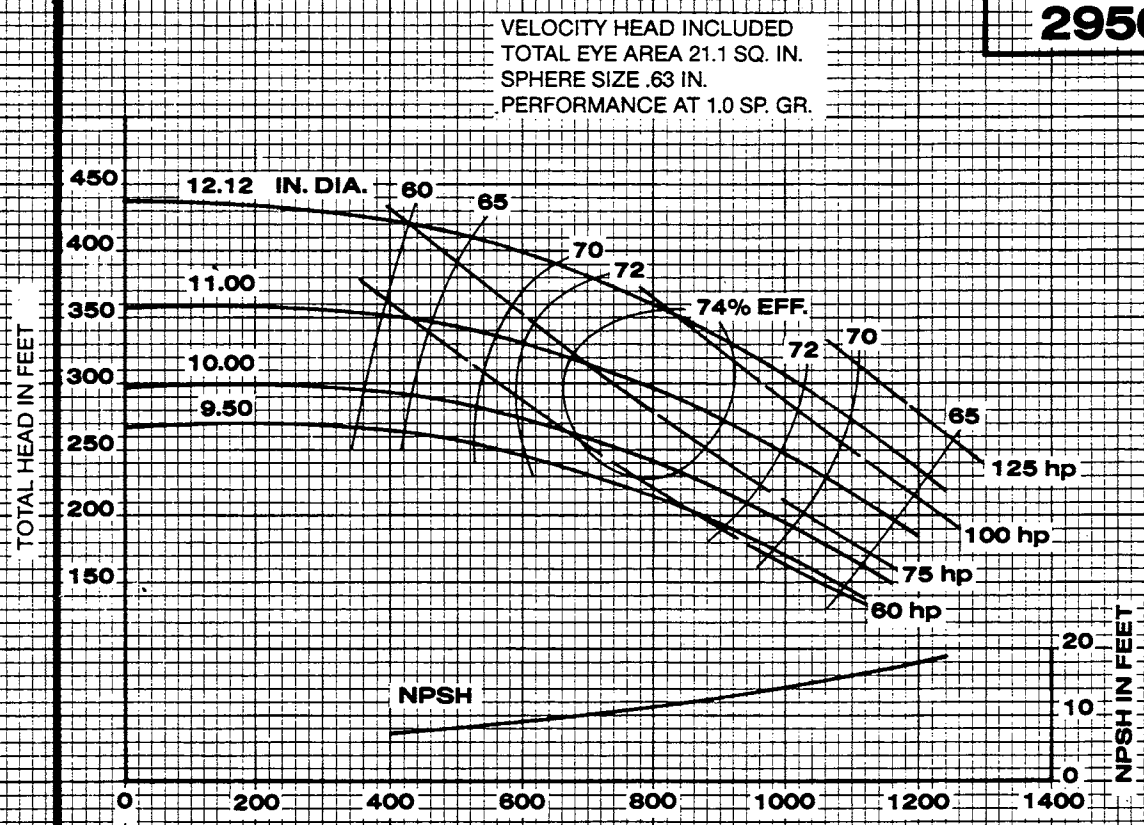

IMPELLER **2692300**

U.S. GALLONS PER MINUTE

CURVE **3132001**



Peerless Pump Company
Indianapolis, IN 46207-7026

HORIZONTAL SPLIT CASE PUMPS
Type 5AE8 Size 5x6x8.12

SECTION 1240

2950 RPM

VELOCITY HEAD INCLUDED
TOTAL EYE AREA 26.3 SQ. IN.
SPHERE SIZE .62 IN.
PERFORMANCE AT 1.0 SP. GR.

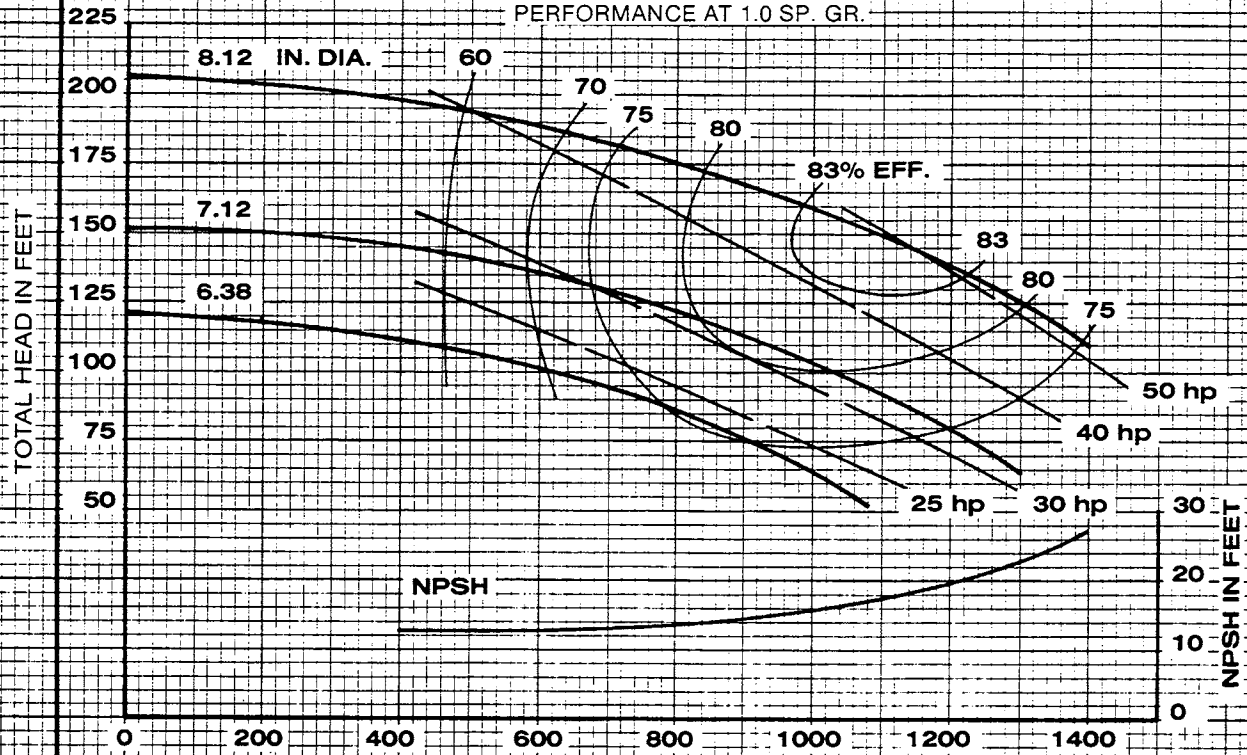

IMPELLER **2693814**

U.S. GALLONS PER MINUTE

CURVE **3112035**



Peerless Pump Company
Indianapolis, IN 46207-7026

HORIZONTAL SPLIT CASE PUMPS
Type 5AE8N Size 5 x 6 x 8.25

SECTION 1240

2950 RPM

VELOCITY HEAD INCLUDED
TOTAL EYE AREA 24.7 SQ. IN.
SPHERE SIZE .63 IN.
PERFORMANCE AT 1.0 SP. GR.

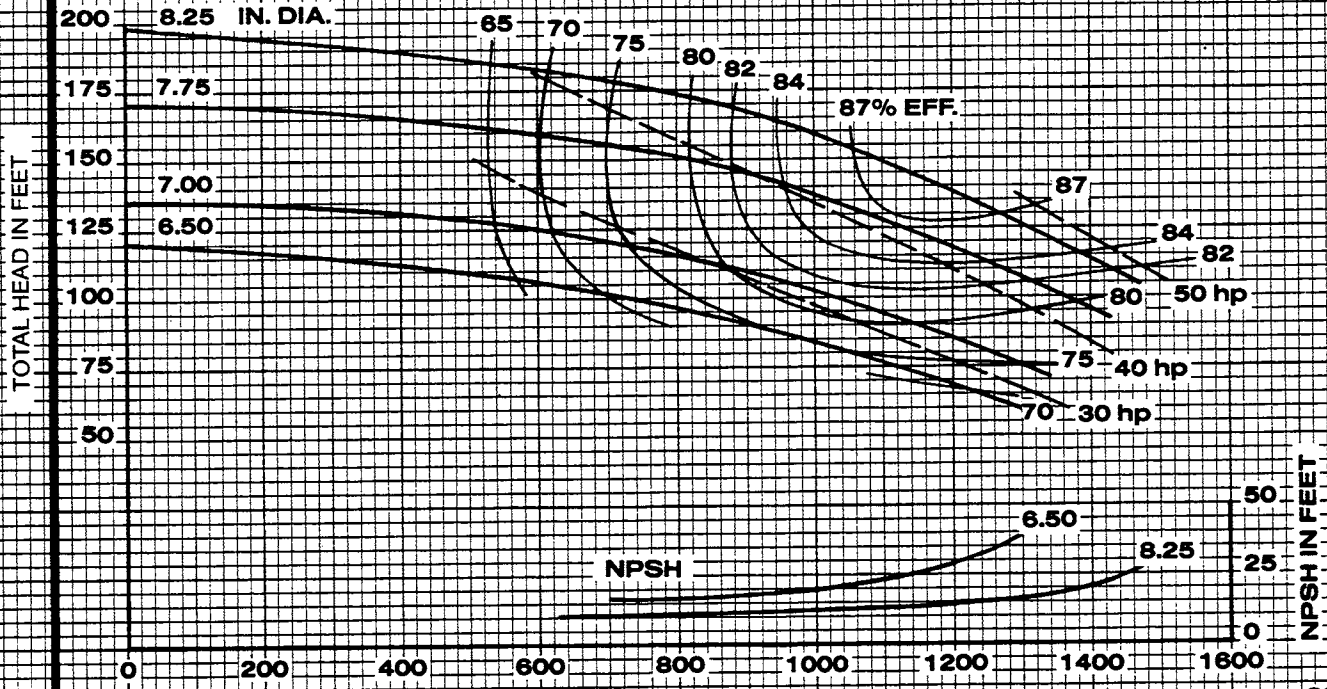

898

IMPELLER **2693816**

U.S. GALLONS PER MINUTE

CURVE **3132106**



Peerless Pump Company
Indianapolis, IN 46207-7026

HORIZONTAL SPLIT CASE PUMPS
Type 5AE11 Size 5x6x10.50

SECTION 1240

2950 RPM

VELOCITY HEAD INCLUDED
TOTAL EYE AREA 24.7 SQ. IN.
SPHERE SIZE .56 IN.
PERFORMANCE AT 1.0 SP. GR.

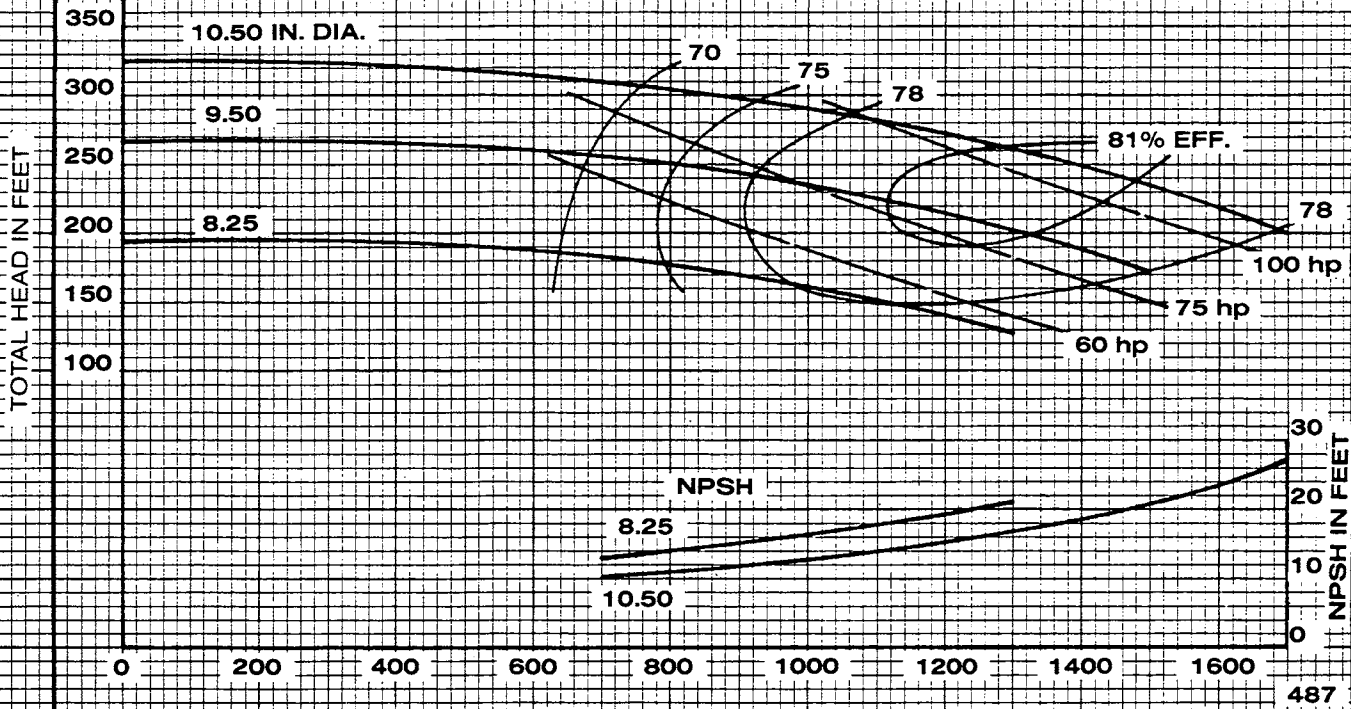

IMPELLER **2693430**

U.S. GALLONS PER MINUTE

CURVE **3132051**



Peerless Pump Company
Indianapolis, IN 46207-7026

HORIZONTAL SPLIT CASE PUMPS
Type 5AE11G Size 5x6x10.50

SECTION 1240

2950 RPM

VELOCITY HEAD INCLUDED
TOTAL EYE AREA 23.5 SQ. IN.
SPHERE SIZE .69 IN.
PERFORMANCE AT 1.0 SP. GR.

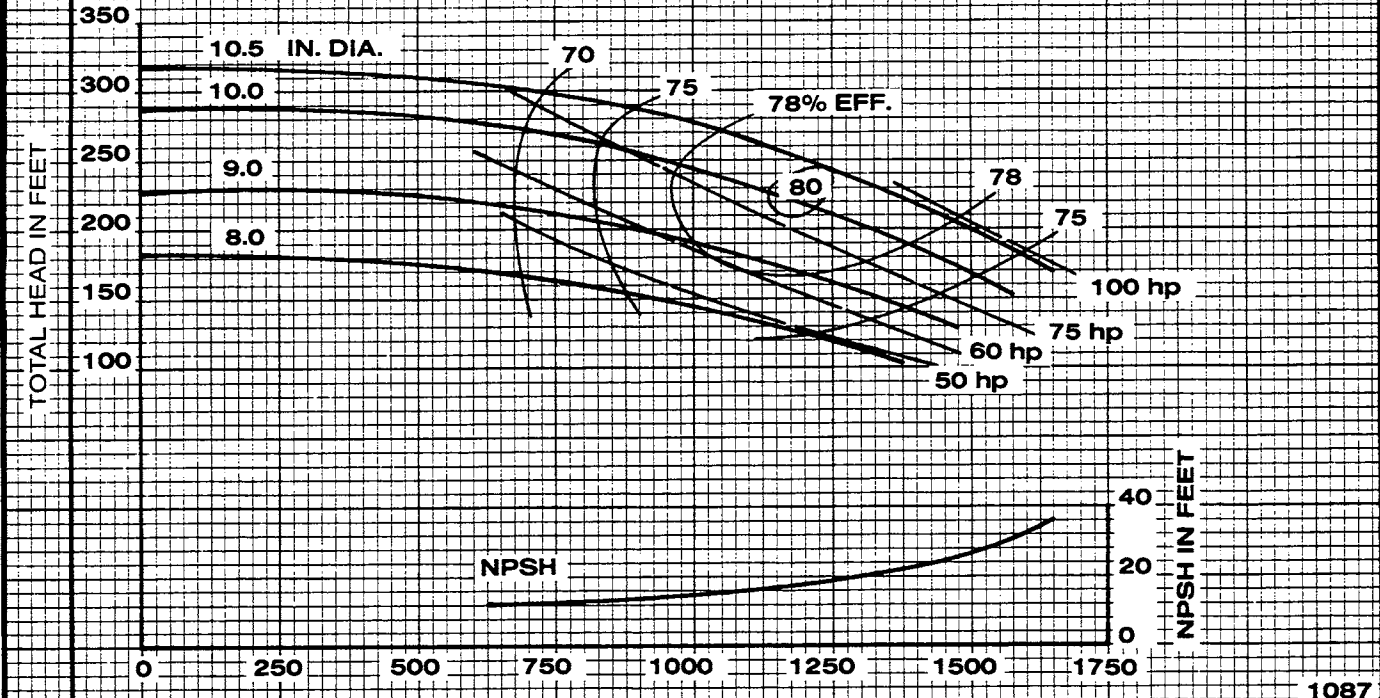

1087

IMPELLER **2693431**

U.S. GALLONS PER MINUTE

CURVE **3132085**



Peerless Pump Company
Indianapolis, IN 46207-7026

HORIZONTAL SPLIT CASE PUMPS
Type 5AE12 Size 5x6x12.00

SECTION 1240

2950 RPM

VELOCITY HEAD INCLUDED
TOTAL EYE AREA 30.3 SQ. IN.
SPHERE SIZE .63 IN.
PERFORMANCE AT 1.0 SP. GR.

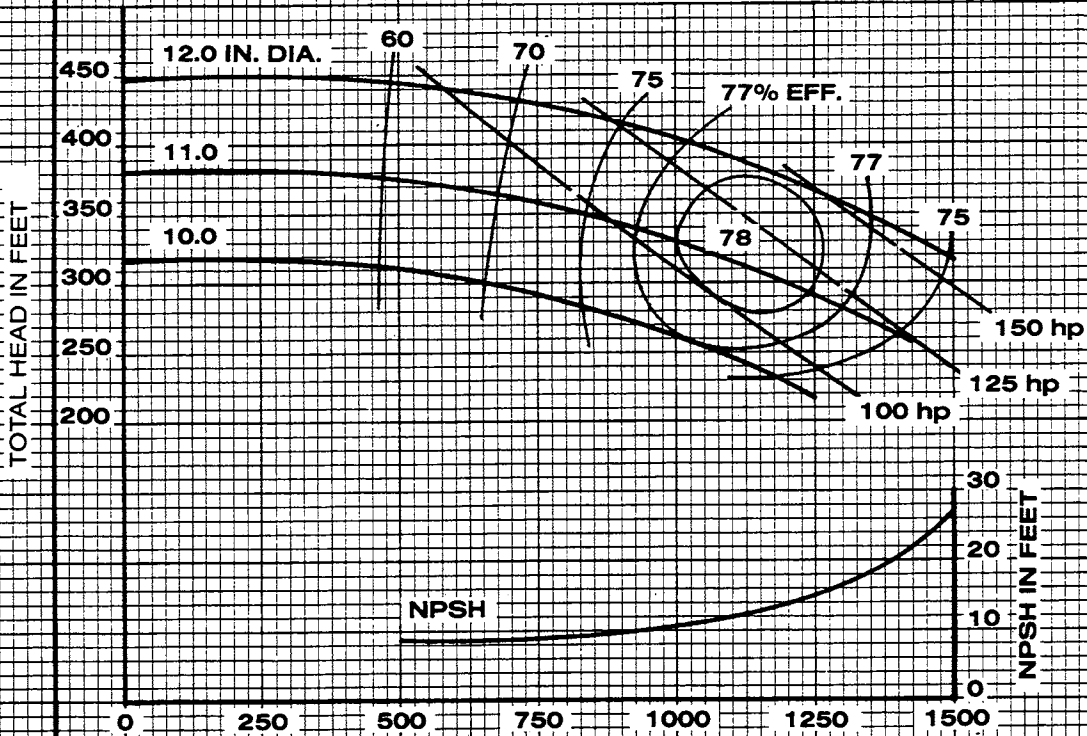

687

IMPELLER 2693460

U.S. GALLONS PER MINUTE

CURVE 3132067



Peerless Pump Company
Indianapolis, IN 46207-7026

HORIZONTAL SPLIT CASE PUMPS
Type 5AE14 Size 5x6x14.00

SECTION 1240

1450 RPM

VELOCITY HEAD INCLUDED
TOTAL EYE AREA 25.14 SQ. IN.
SPHERE SIZE .70 IN.
PERFORMANCE AT 1.0 SP. GR.

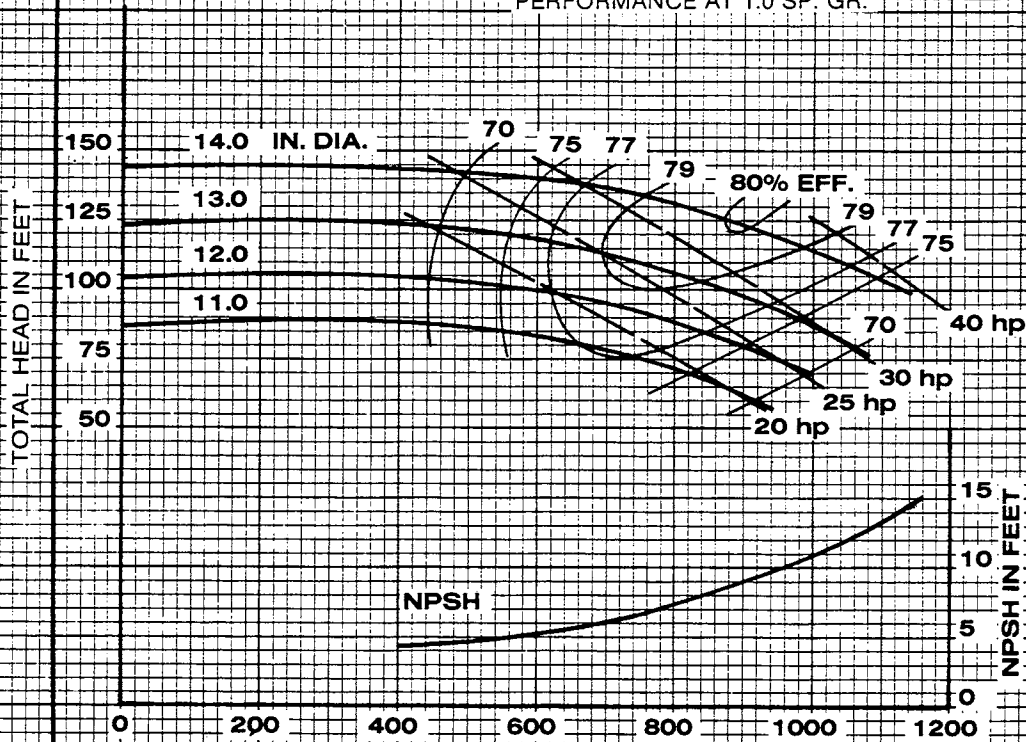

1186

IMPELLER **2693456**

U.S. GALLONS PER MINUTE

CURVE **3132031**



Peerless Pump Company
Indianapolis, IN 46207-7026

HORIZONTAL SPLIT CASE PUMPS
Type 5AE14G Size 5 x 6 x 14.00

SECTION 1240

1450 RPM

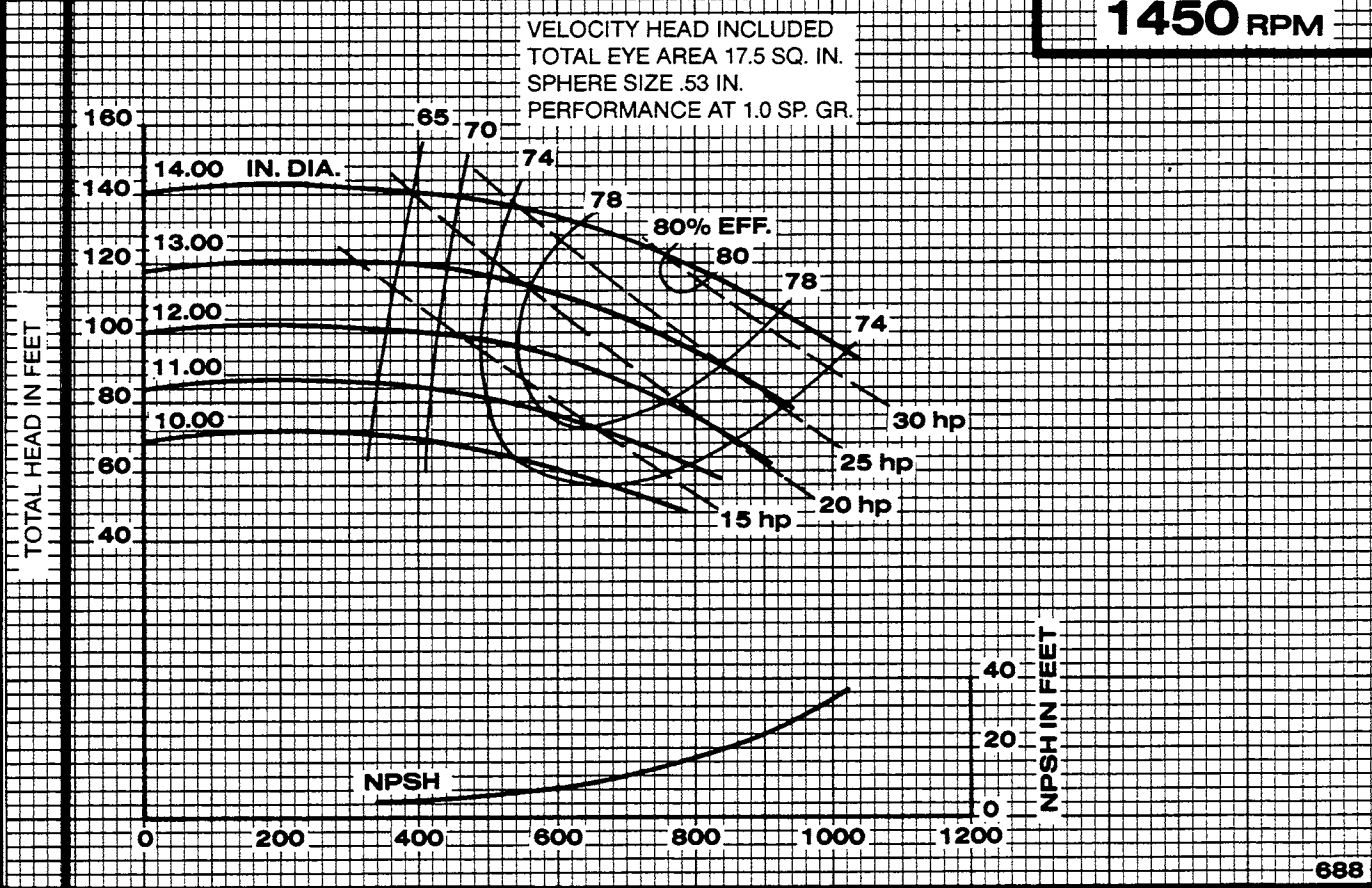

688

IMPELLER **2694349** U.S. GALLONS PER MINUTE CURVE **3132101**



Peerless Pump Company
Indianapolis, IN 46207-7026

HORIZONTAL SPLIT CASE PUMPS
Type 5AE14N Size 5 x 6 x 14

SECTION 1240

1450 RPM

VELOCITY HEAD INCLUDED
TOTAL EYE AREA 15.5 SQ. IN.
SPHERE SIZE .56 IN.
PERFORMANCE AT 1.0 SP. GR.

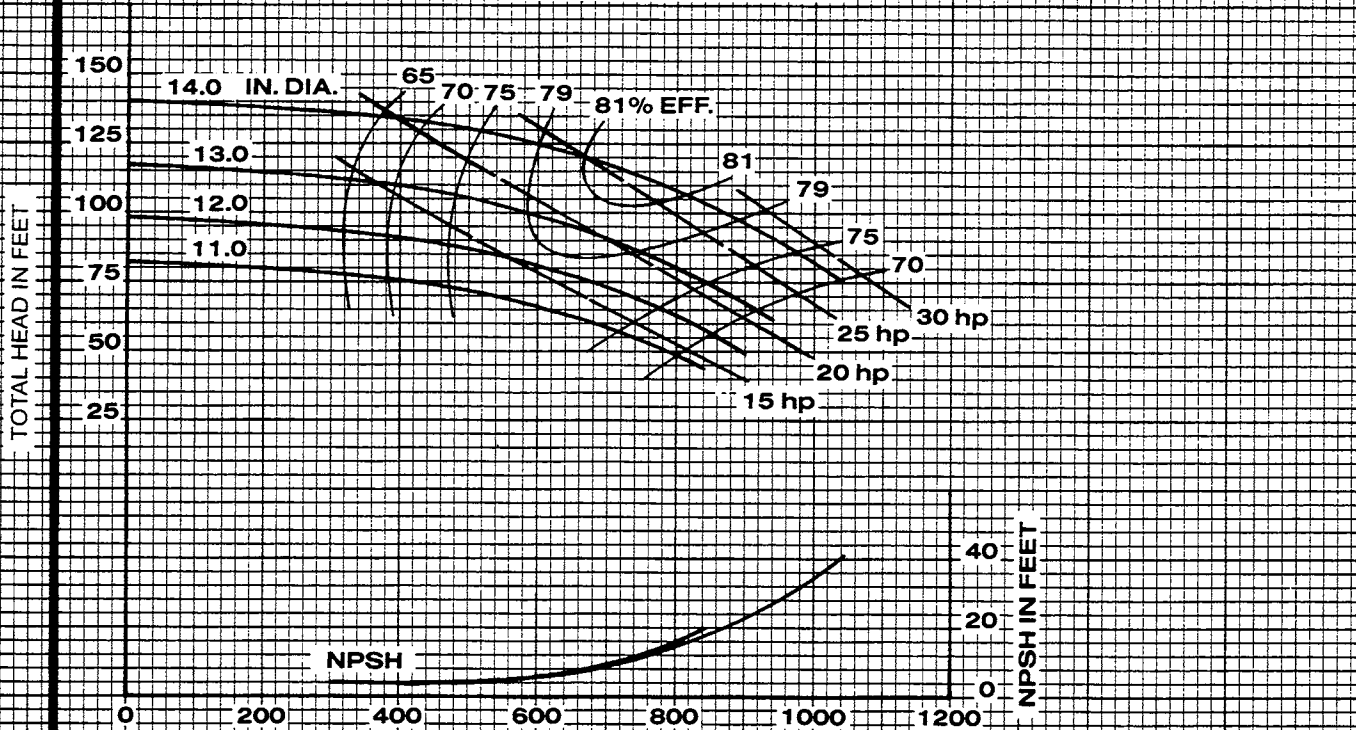

IMPELLER **2694394**

U.S. GALLONS PER MINUTE

CURVE **3132115**



Peerless Pump Company
Indianapolis, IN 46207-7026

HORIZONTAL SPLIT CASE PUMPS
Type 6AE11 Size 6x6x10.50

SECTION 1240

1450 RPM

VELOCITY HEAD INCLUDED
TOTAL EYE AREA 33.0 SQ. IN.
SPHERE SIZE .95 IN.
PERFORMANCE AT 1.0 SP. GR.

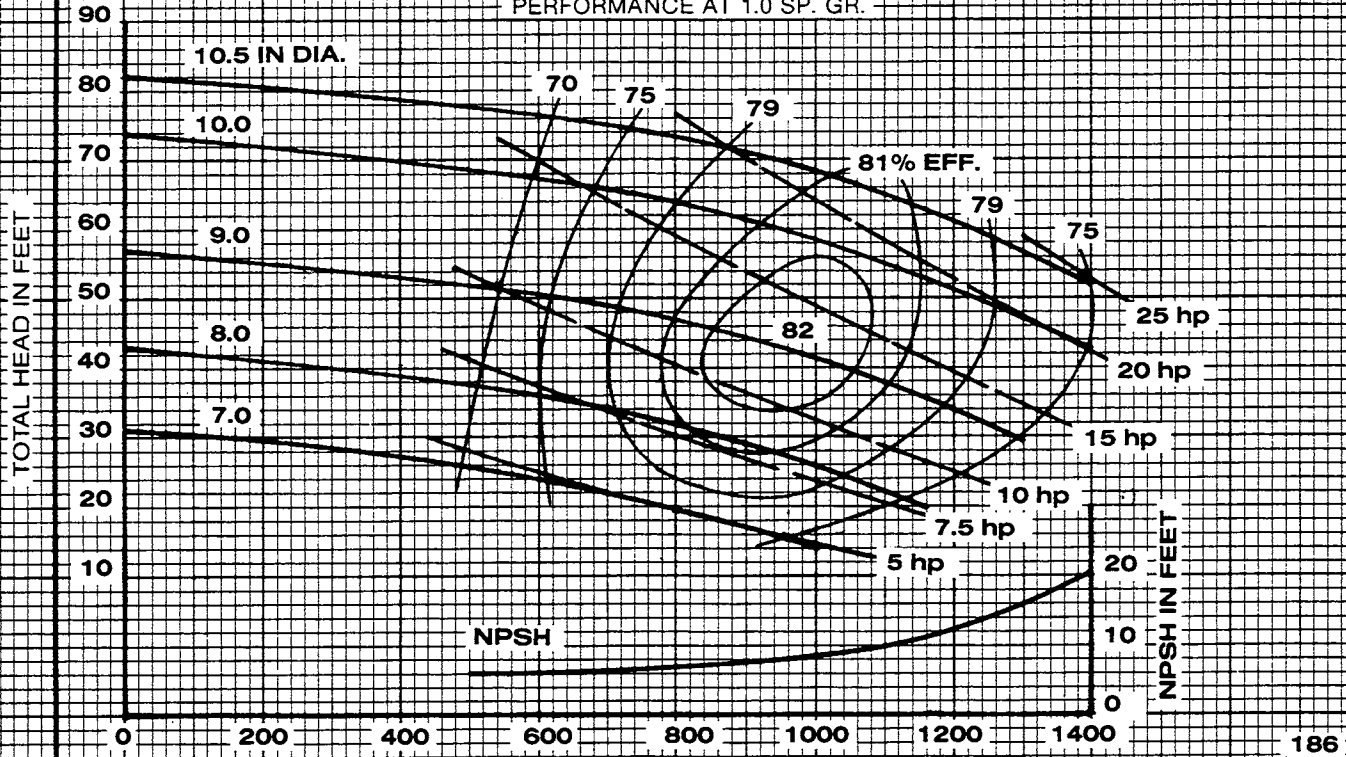

IMPELLER 2692848

U.S. GALLONS PER MINUTE

CURVE 3112033



Peerless Pump Company
Indianapolis, IN 46207-7026

HORIZONTAL SPLIT CASE PUMPS
Type 6AE12 Size 6x8x12.25

SECTION 1240

2950 RPM

VELOCITY HEAD INCLUDED
TOTAL EYE AREA 45.0 SQ. IN.
SPHERE SIZE .64 IN.
PERFORMANCE AT 1.0 SP. GR.

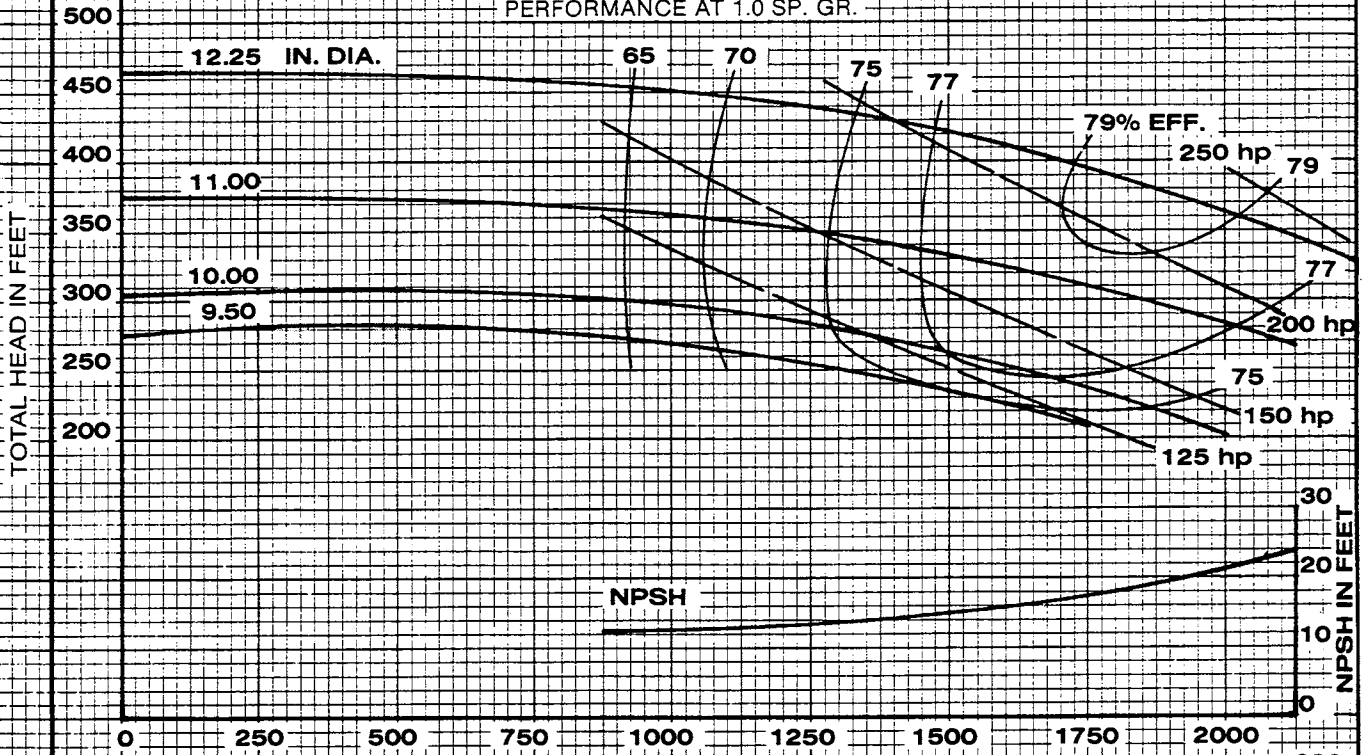

IMPELLER **2692443**

U.S. GALLONS PER MINUTE

CURVE **3132007**



Peerless Pump Company
Indianapolis, IN 46207-7026

HORIZONTAL SPLIT CASE PUMPS
Type 6AE14 Size 6x8x14.00

SECTION 1240

1450 RPM

VELOCITY HEAD INCLUDED
TOTAL EYE AREA 30.63 SQ. IN.
SPHERE SIZE .75 IN.
PERFORMANCE AT 1.0 SP. GR.

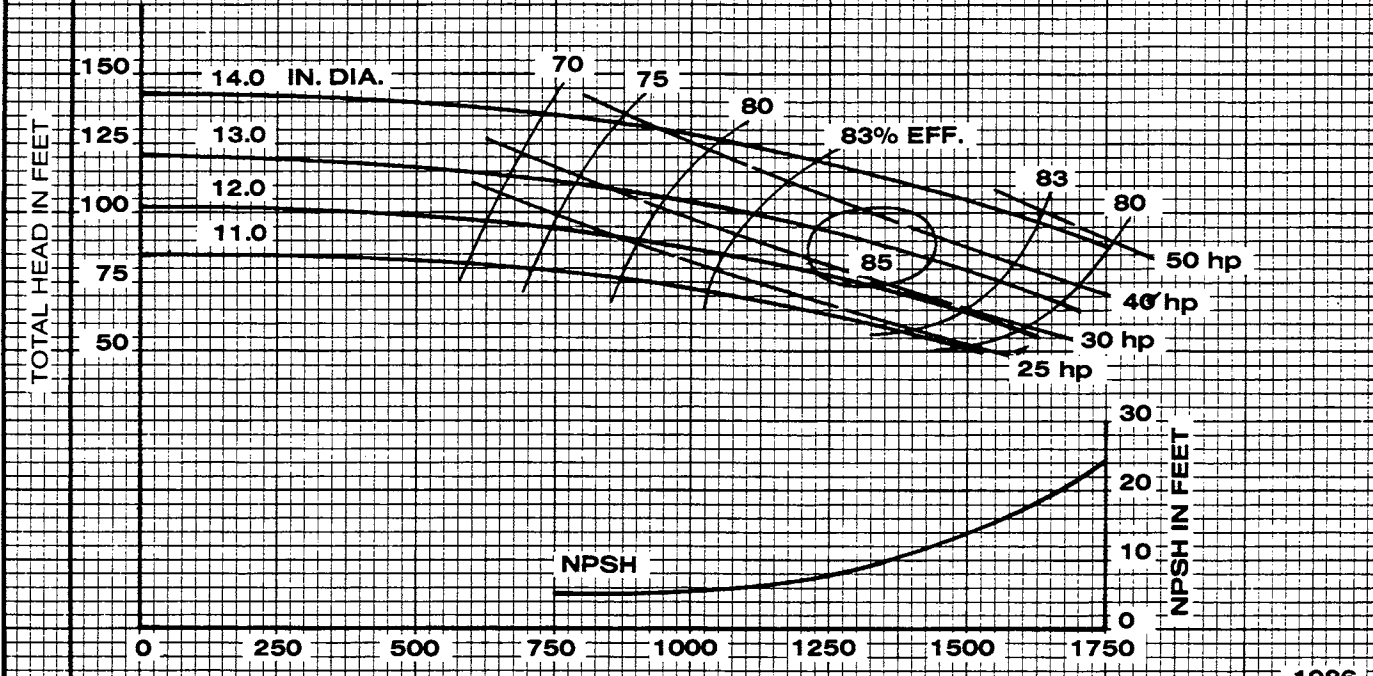

1086

IMPELLER 2693077	U.S. GALLONS PER MINUTE	CURVE 3132028
-------------------------	-------------------------	----------------------



Peerless Pump Company
Indianapolis, IN 46207-7026

HORIZONTAL SPLIT CASE PUMPS
Type 6AE14G Size 6x8x14.00

SECTION 1240

1450 RPM

VELOCITY HEAD INCLUDED
TOTAL EYE AREA 31.09 SQ. IN.
SPHERE SIZE .98 IN.
PERFORMANCE AT 1.0 SP. GR.

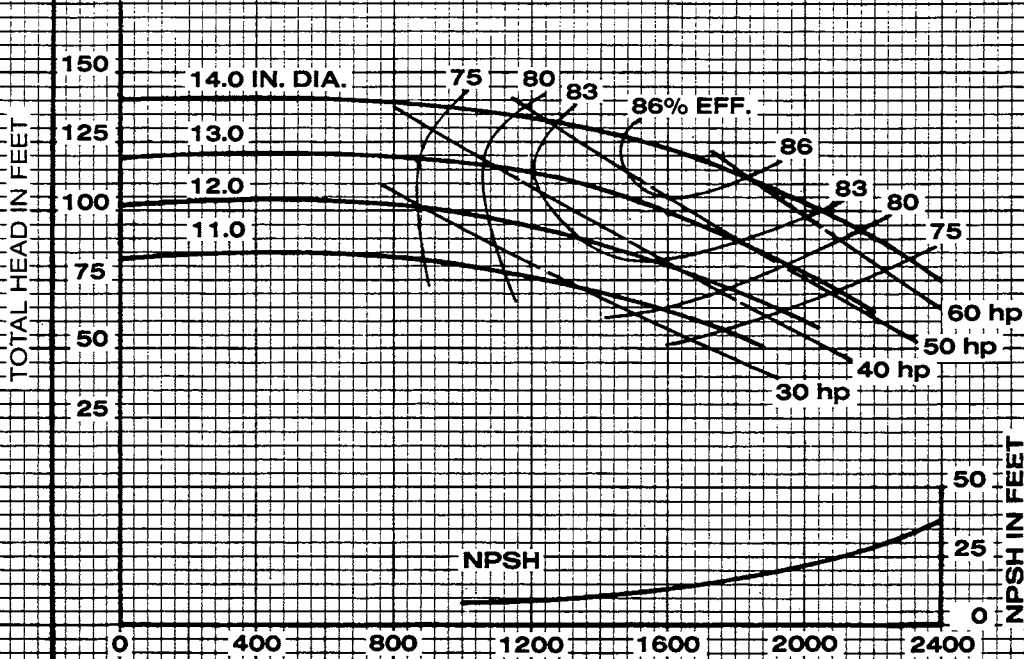

1286

IMPELLER **2693078**

U.S. GALLONS PER MINUTE

CURVE **3132034**



Peerless Pump Company
Indianapolis, IN 46207-7026

HORIZONTAL SPLIT CASE PUMPS
SINGLE STAGE DOUBLE SUCTION
Type 6AE14N Size 6 x 8 x 15.25

SECTION 1240

1450 RPM

Total Head in Feet

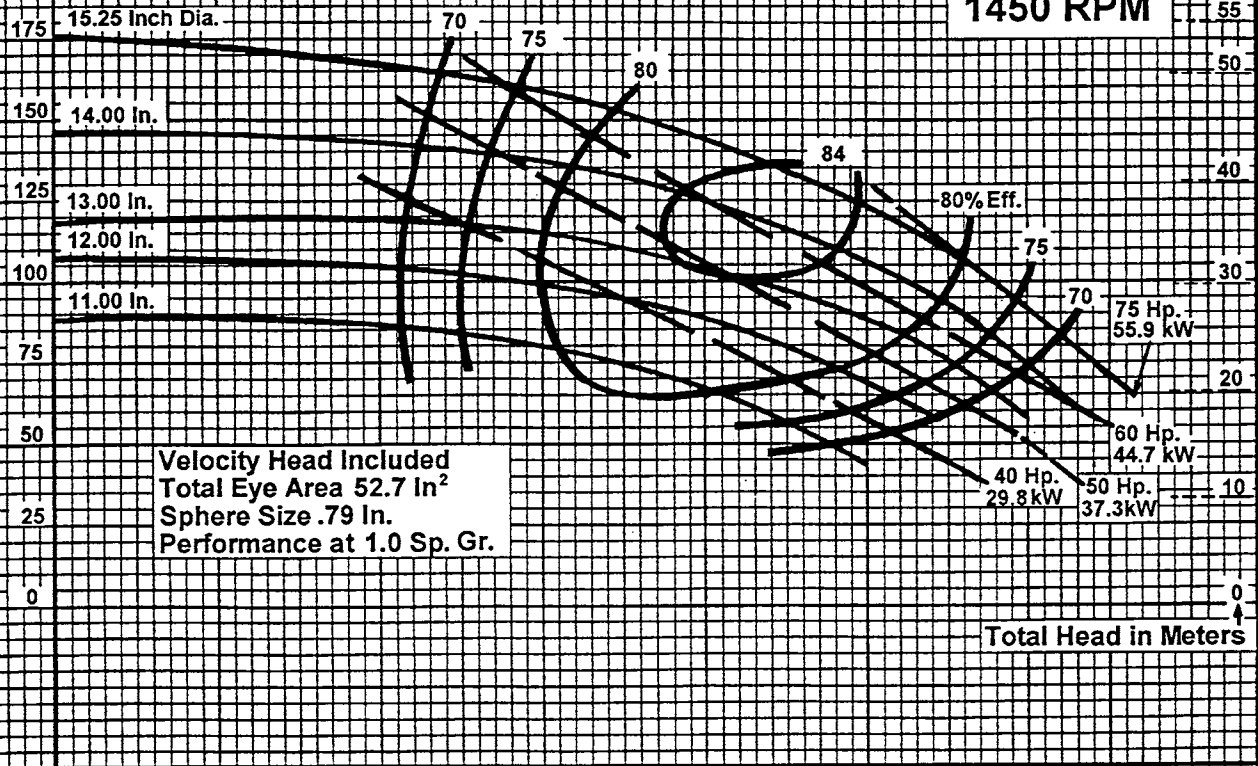

Total Head in Meters

0 400 800 1200 1600 2000 2400 2800

U.S. Gallons Per Minute

100 200 300 400 500 600

Cubic Meters Per Hour

Impeller 2696341

Curve 3122147



Peerless Pump Company
Indianapolis, IN 46207-7026

HORIZONTAL SPLIT CASE PUMPS
Type 6AE16 Size 6x8x16.75

SECTION 1240

1450 RPM

VELOCITY HEAD INCLUDED
TOTAL EYE AREA 37.69 SQ. IN.
SPHERE SIZE .70 IN.
PERFORMANCE AT 1.0 SP. GR.

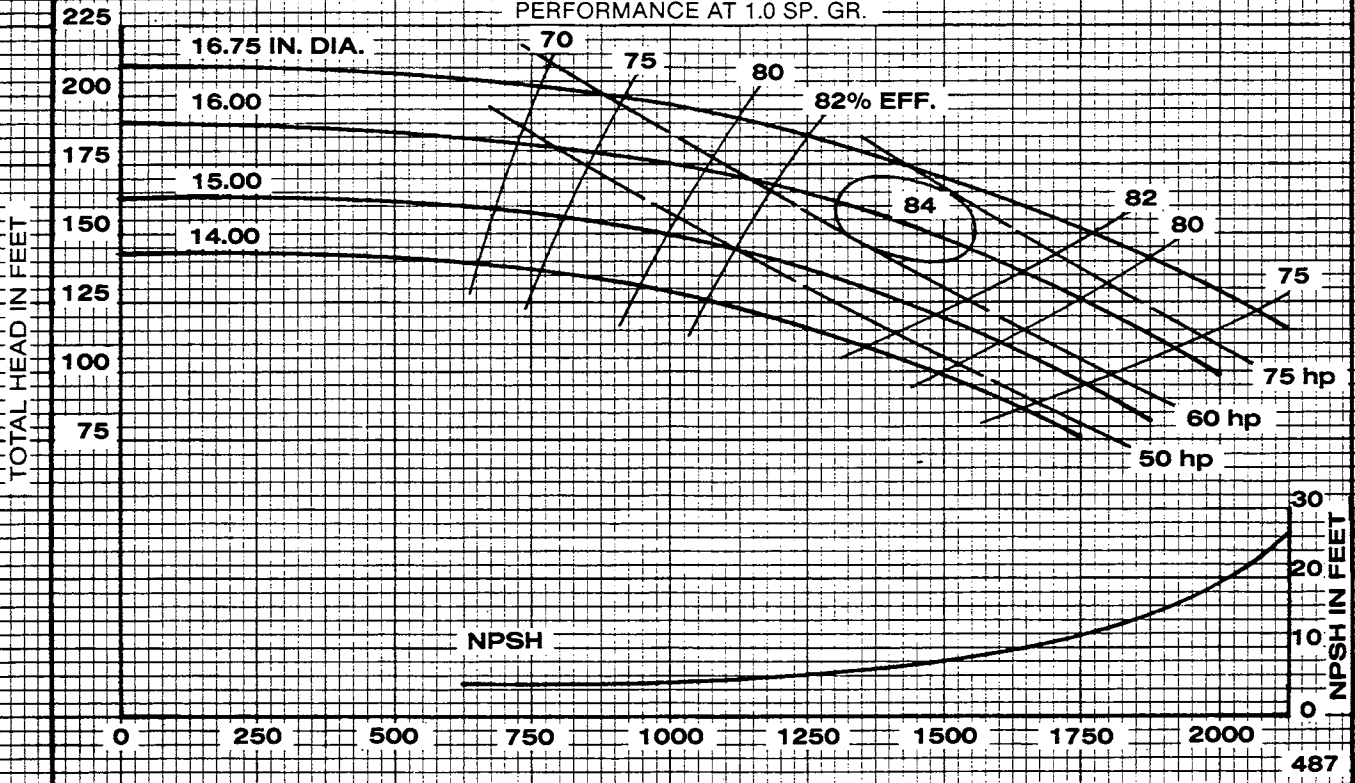

IMPELLER 2692932

U.S. GALLONS PER MINUTE

CURVE 3132054



Peerless Pump Company
Indianapolis, IN 46207-7026

HORIZONTAL SPLIT CASE PUMPS
Type 6AE16G Size 6 x 8 x 16.75

SECTION 1240

1450 RPM

VELOCITY HEAD INCLUDED
TOTAL EYE AREA 21.8 SQ. IN.
SPHERE SIZE .50 IN.
PERFORMANCE AT 1.0 SP. GR.

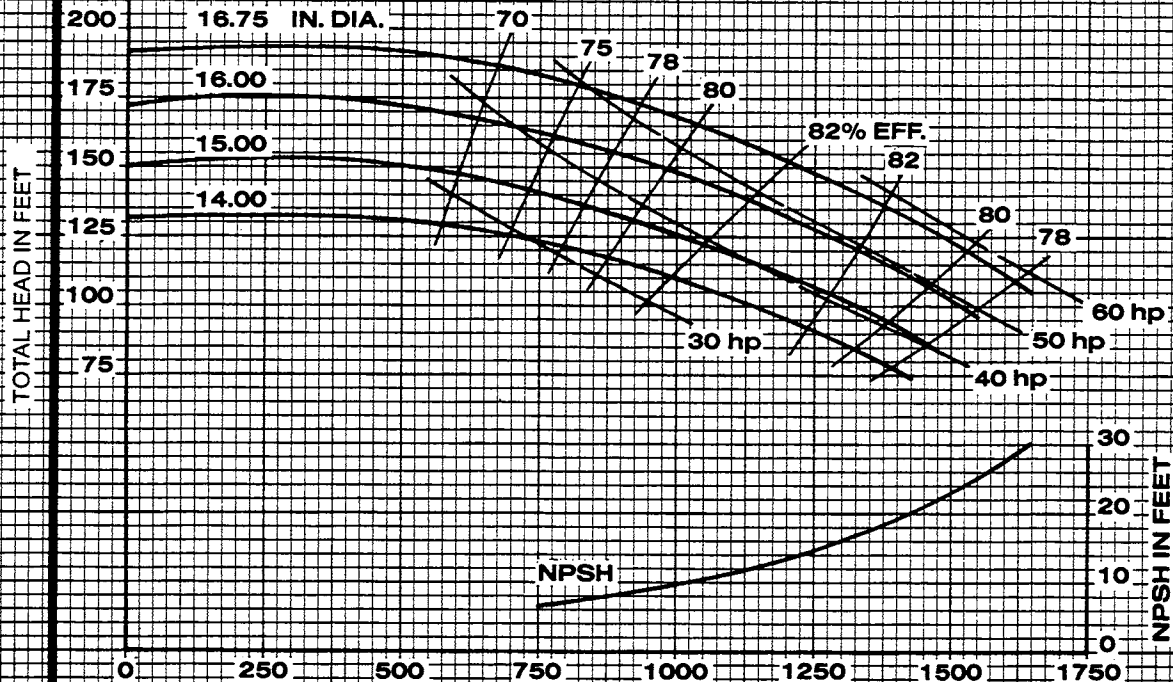

1088

IMPELLER **2692933**

U.S. GALLONS PER MINUTE

CURVE **3132109**



Peerless Pump Company
Indianapolis, IN 46207-7026

HORIZONTAL SPLIT CASE PUMPS
Type 6AE16V Size 6x8x17.00

SECTION 1240

1450 RPM

VELOCITY HEAD INCLUDED
TOTAL EYE AREA 24.6 SQ. IN.
SPHERE SIZE .56 IN.
PERFORMANCE AT 1.0 SP. GR.

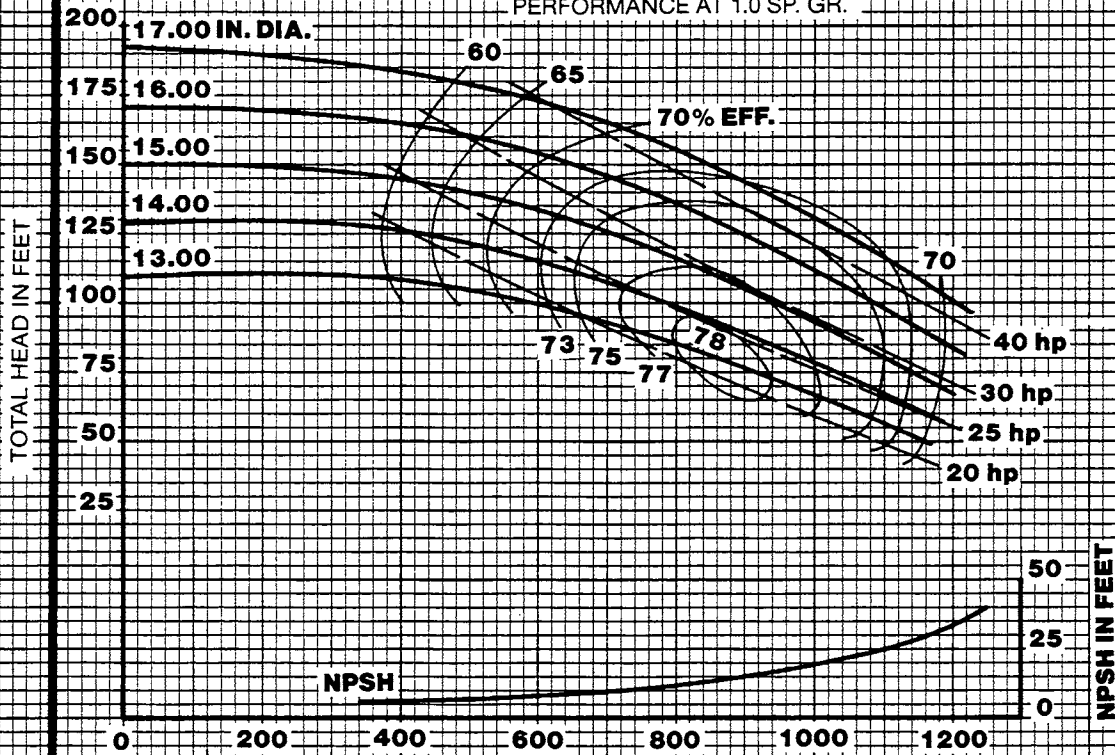

488

IMPELLER **2684461**

U.S. GALLONS PER MINUTE

CURVE **3132098**



Peerless Pump Company
Indianapolis, IN 46207-7026

HORIZONTAL SPLIT CASE PUMPS
Type 6AE16N Size 6x8x16.75

SECTION 1240

1450 RPM

VELOCITY HEAD INCLUDED
TOTAL EYE AREA 27.5 SQ. IN.
SPHERE SIZE .60 IN.
PERFORMANCE AT 1.0 SP. GR.

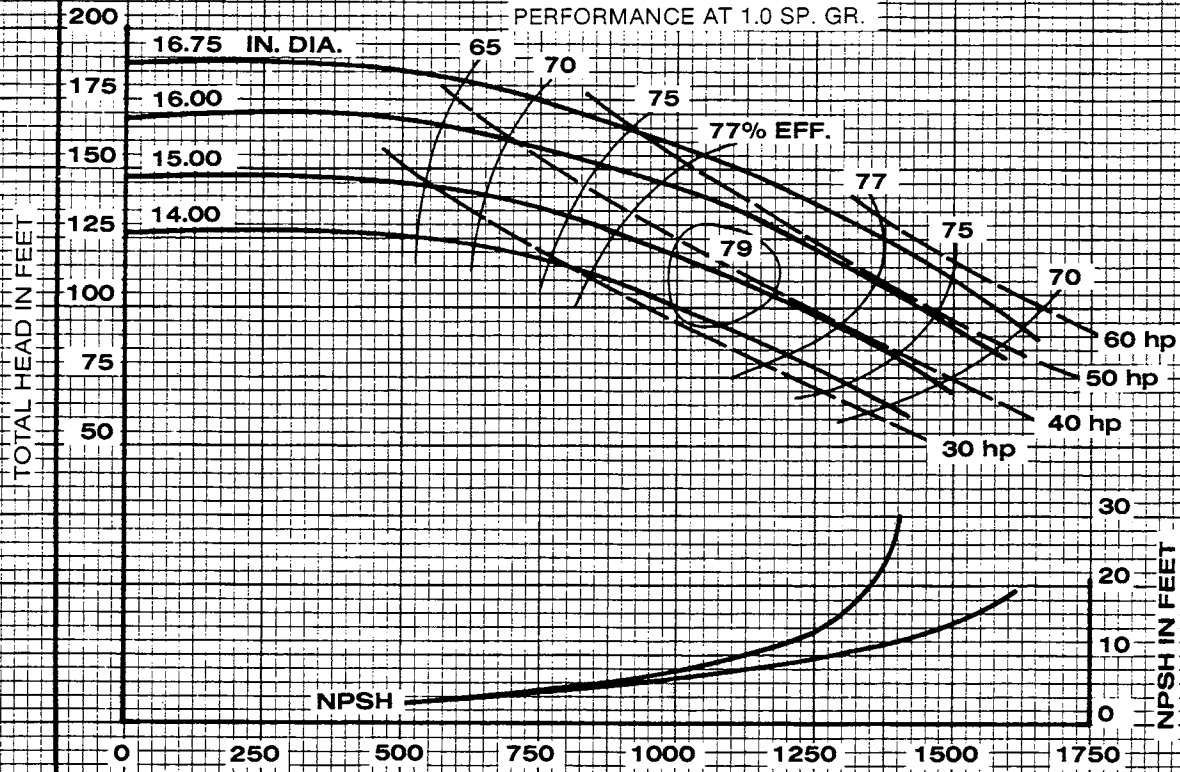

IMPELLER **2692931**

U.S. GALLONS PER MINUTE

CURVE **3132088**

1187



Peerless Pump Company
Indianapolis, IN 46207-7026

HORIZONTAL SPLIT CASE PUMPS

Type 6AE18

Size 6 x 8 x 17.50

SECTION 1240

1460 RPM

VELOCITY HEAD INCLUDED
TOTAL EYE AREA 39.0 SQ. IN.
SPHERE SIZE .80 IN.
PERFORMANCE AT 1.0 SP. GR.

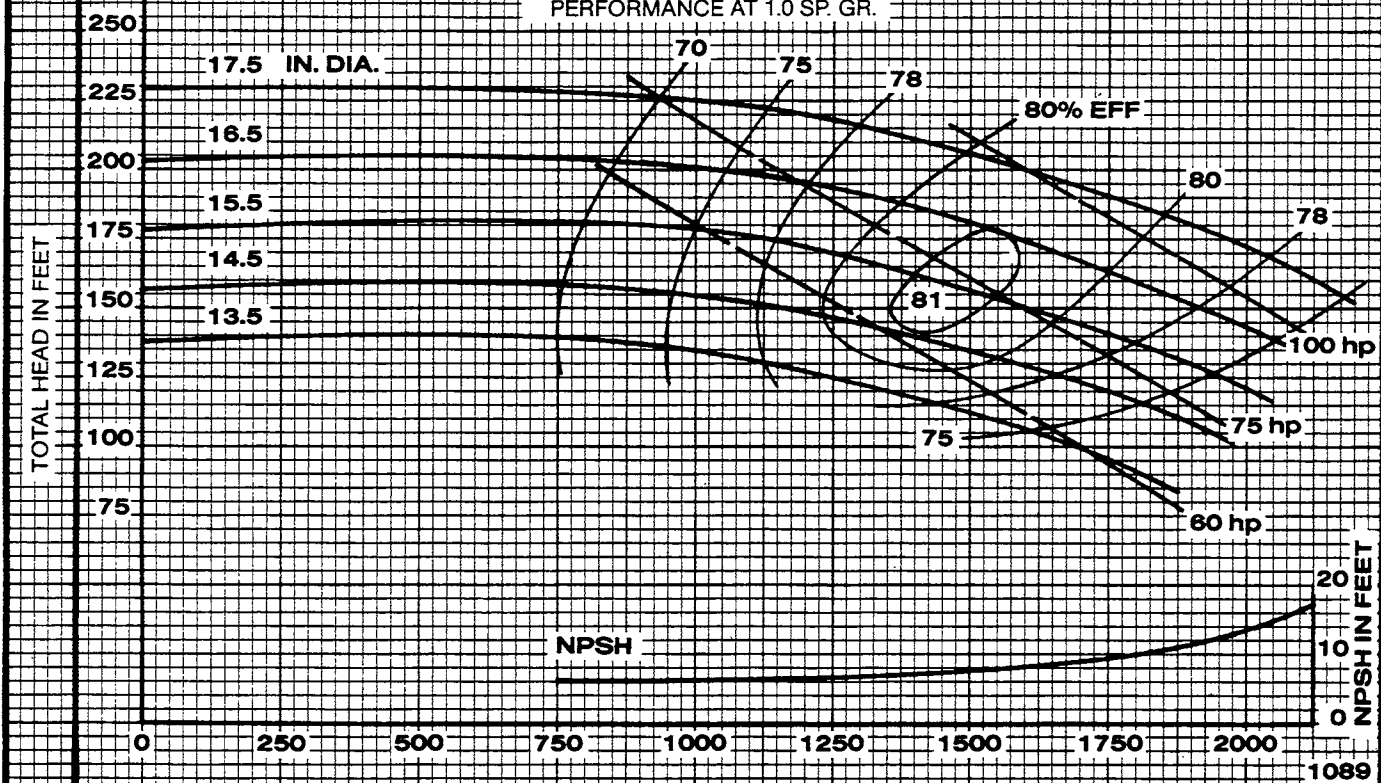

IMPELLER **2693457**

U.S. GALLONS PER MINUTE

CURVE **3132118**



Peerless Pump Company
Indianapolis, IN 46207-7026

HORIZONTAL SPLIT CASE PUMPS
Type 8AE12 Size 8x8x12.00

SECTION 1240

1450 RPM

VELOCITY HEAD INCLUDED
TOTAL EYE AREA 44.8 SQ. IN.
SPHERE SIZE 1.15 IN.
PERFORMANCE AT 1.0 SP. GR.

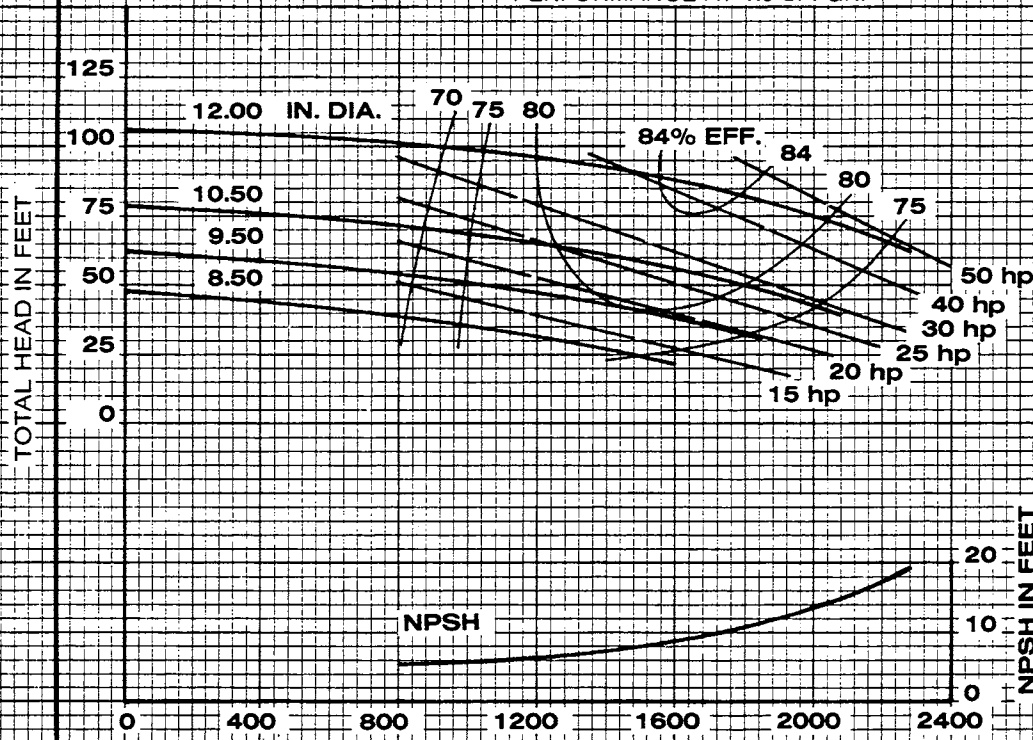

986

IMPELLER 2692806

U.S. GALLONS PER MINUTE

CURVE 3132018



Peerless Pump Company
Indianapolis, IN 46207-7026

HORIZONTAL SPLIT CASE PUMPS
Type 8AE13 Size 8x10x13.00

SECTION 1240

1450 RPM

VELOCITY HEAD INCLUDED
TOTAL EYE AREA 63.50 SQ. IN.
SPHERE SIZE .85 IN.
PERFORMANCE AT 1.0 SP. GR.

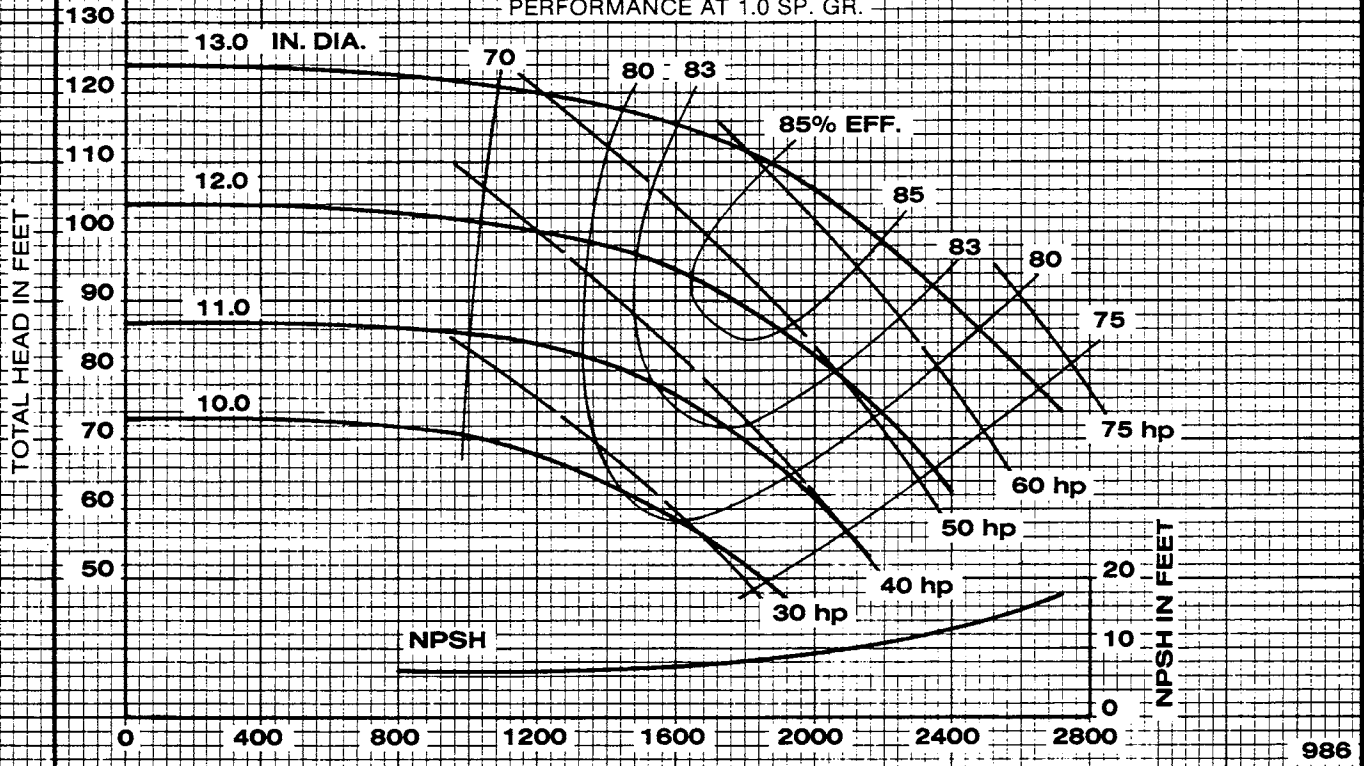

IMPELLER **2693445**

U.S. GALLONS PER MINUTE

CURVE **3132024**



Peerless Pump Company
Indianapolis, IN 46207-7026

HORIZONTAL SPLIT CASE PUMPS
Type 8AE15 Size 8 x 10 x 15.50

SECTION 1240

1450 RPM

VELOCITY HEAD INCLUDED
TOTAL EYE AREA 74.50 SQ. IN.
SPHERE SIZE 1.38 IN.
PERFORMANCE AT 1.0 SP. GR.

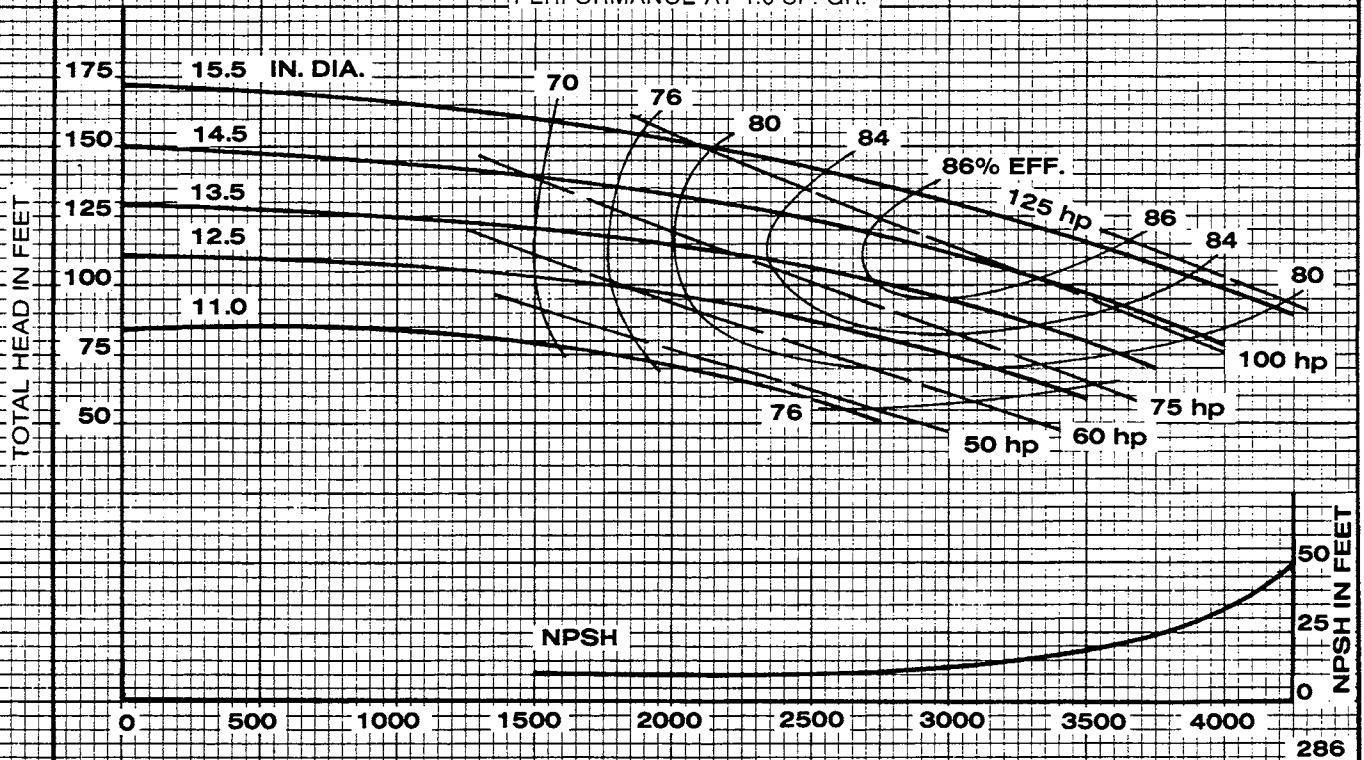

IMPELLER **2692769**

U.S. GALLONS PER MINUTE

CURVE **3112027r**



Peerless Pump Company
Indianapolis, IN 46207-7026

HORIZONTAL SPLIT CASE PUMPS
Type 8AE15G Size 8x10x15.50

SECTION 1240

1450 RPM

VELOCITY HEAD INCLUDED
TOTAL EYE AREA 51.0 SQ. IN.
SPHERE SIZE .74 IN.
PERFORMANCE AT 1.0 SP. GR.

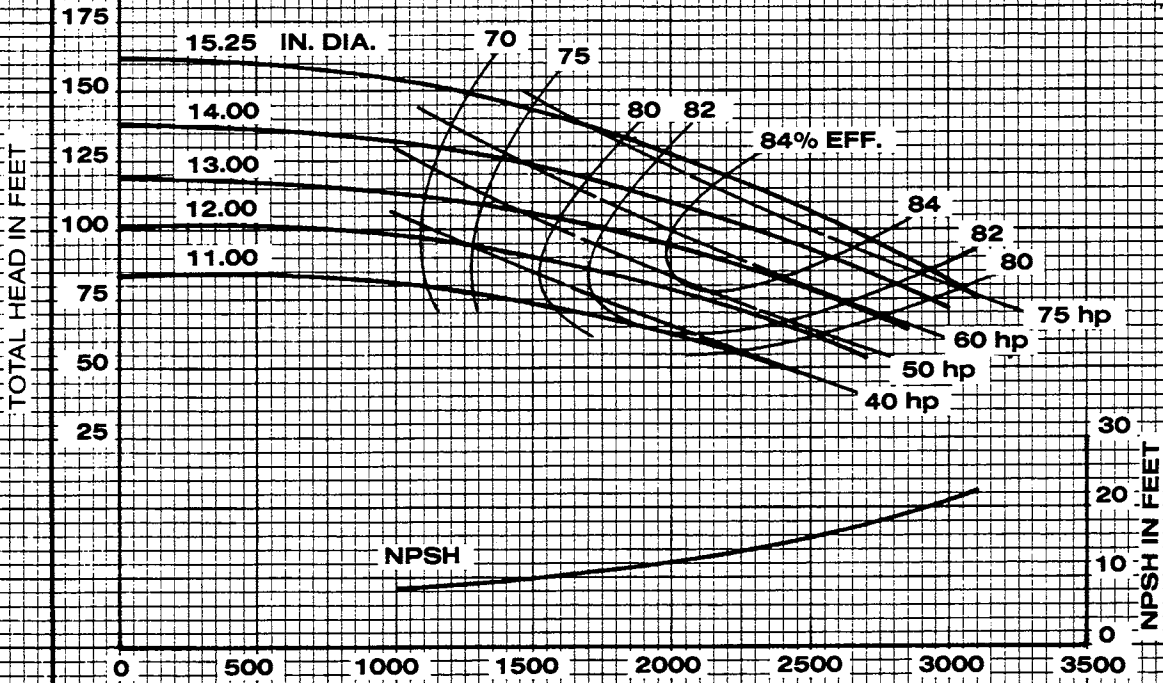

IMPELLER 2694320

U.S. GALLONS PER MINUTE

CURVE 3132082



Peerless Pump Company
Indianapolis, IN 46207-7026

HORIZONTAL SPLIT CASE PUMPS
Type 8AE17A Size 8 x 10 x 17

SECTION 1240

1460 RPM

VELOCITY HEAD INCLUDED
TOTAL EYE AREA 65.0 SQ. IN.
SPHERE SIZE .95 IN.
PERFORMANCE AT 1.0 SP. GR.

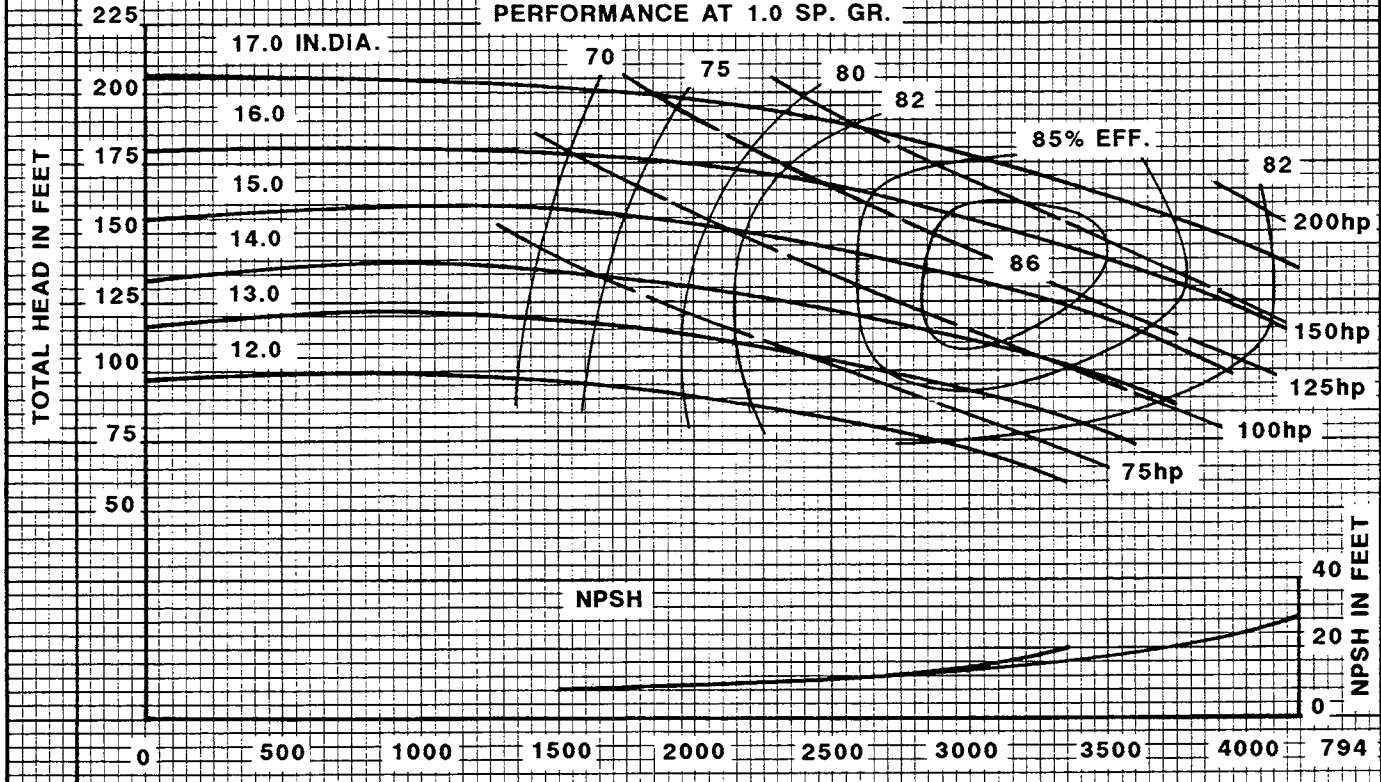

IMPELLER 2693259

U.S. GALLONS PER MINUTE

CURVE 3132140



Peerless Pump Company
Indianapolis, IN 46207-7026

HORIZONTAL SPLIT CASE PUMPS
Type 8AE17Q Size 8 x 10 x 17

SECTION 1240

1460 RPM

VELOCITY HEAD INCLUDED
TOTAL EYE AREA 55.8 SQ. IN.
SPHERE SIZE .94 IN.
PERFORMANCE AT 1.0 SP. GR.

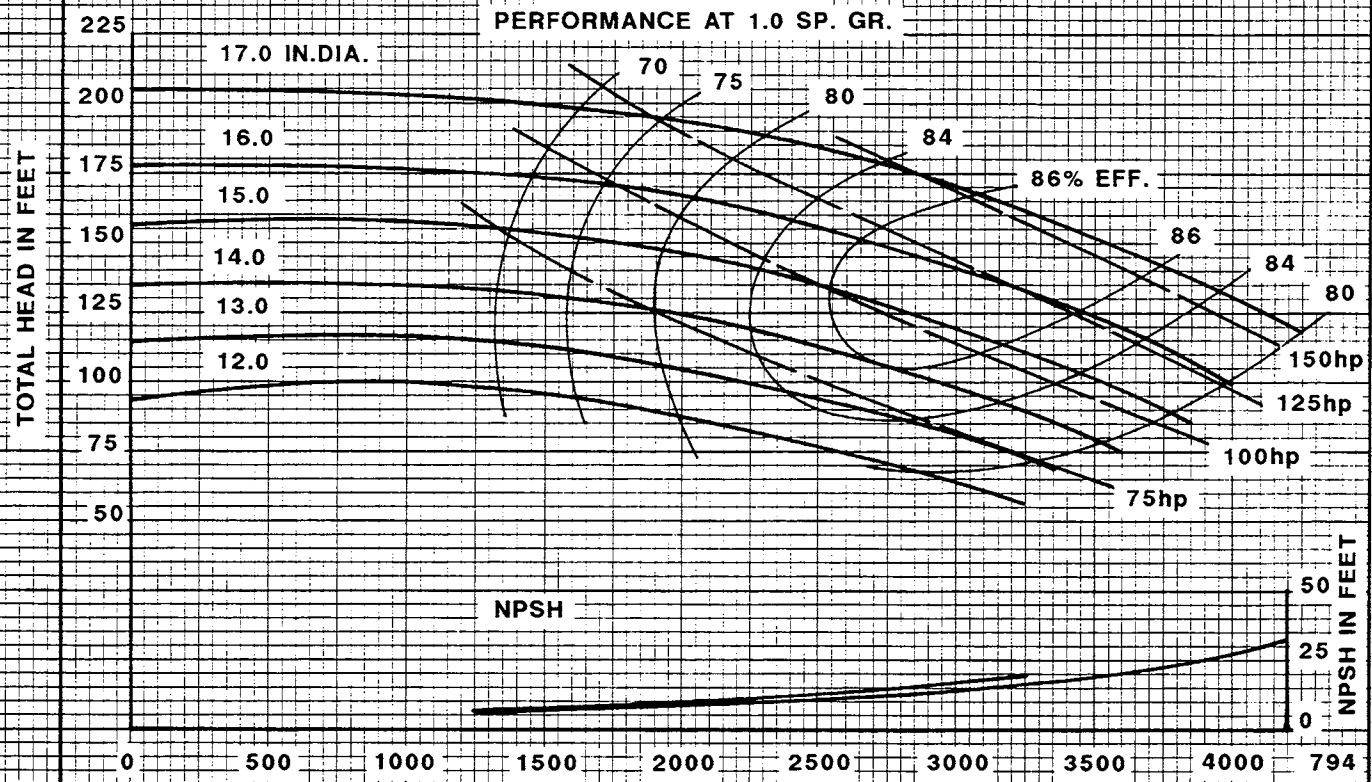

IMPELLER 2693257

U.S. GALLONS PER MINUTE

CURVE 3132143



Peerless Pump Company
Indianapolis, IN 46207-7026

HORIZONTAL SPLIT CASE PUMPS
Type 8AE20 Size 8x10x19.00

SECTION 1240

1465 RPM

VELOCITY HEAD INCLUDED
TOTAL EYE AREA 48.5 SQ. IN.
SPHERE SIZE .75 IN.
PERFORMANCE AT 1.0 SP. GR.

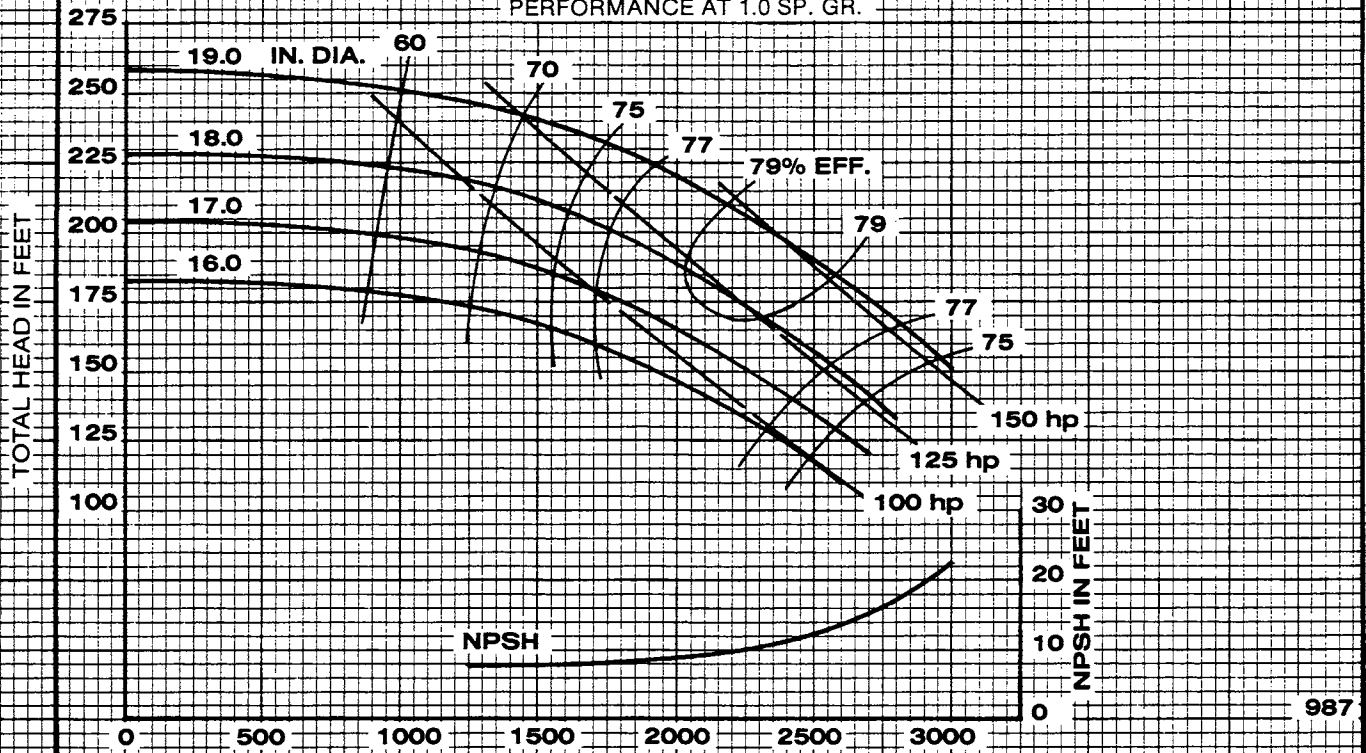

IMPELLER 2693333

U.S. GALLONS PER MINUTE

CURVE 3132070



Peerless Pump Company
Indianapolis, IN 46207-7026

HORIZONTAL SPLIT CASE PUMPS
Type 8AE20G Size 8x10x20.00

SECTION 1240

1465 RPM

VELOCITY HEAD INCLUDED
TOTAL EYE AREA 59.2 SQ. IN.
SPHERE SIZE .75 IN.
PERFORMANCE AT 1.0 SP. GR.

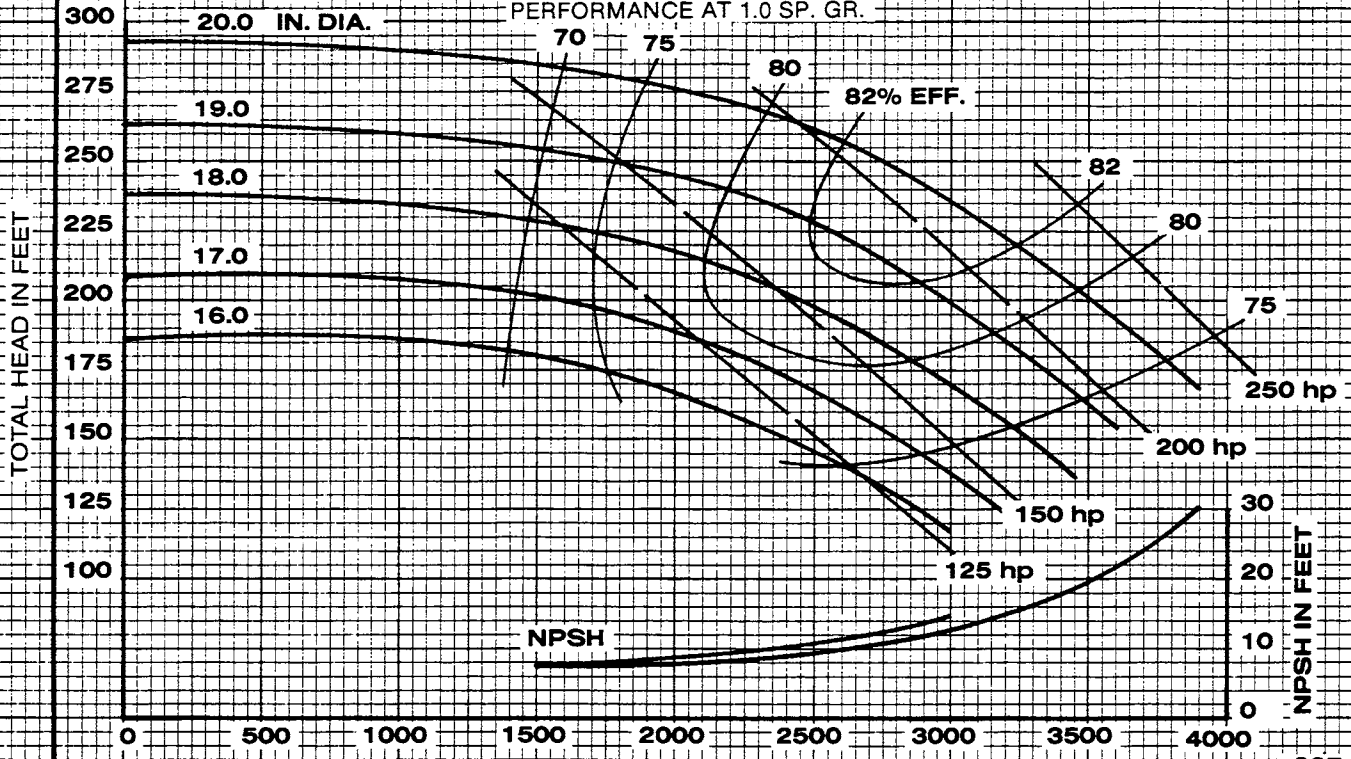

IMPELLER 2693332

U.S. GALLONS PER MINUTE

CURVE 3132076



Peerless Pump Company
Indianapolis, IN 46207-7026

HORIZONTAL SPLIT CASE PUMPS
Type 10AE12 Size 10 x 10 x 12.00

SECTION 1240

1450 RPM

VELOCITY HEAD INCLUDED
TOTAL EYE AREA 64.4 SQ. IN.
SPHERE SIZE .77 IN.
PERFORMANCE AT 1.0 SP. GR.

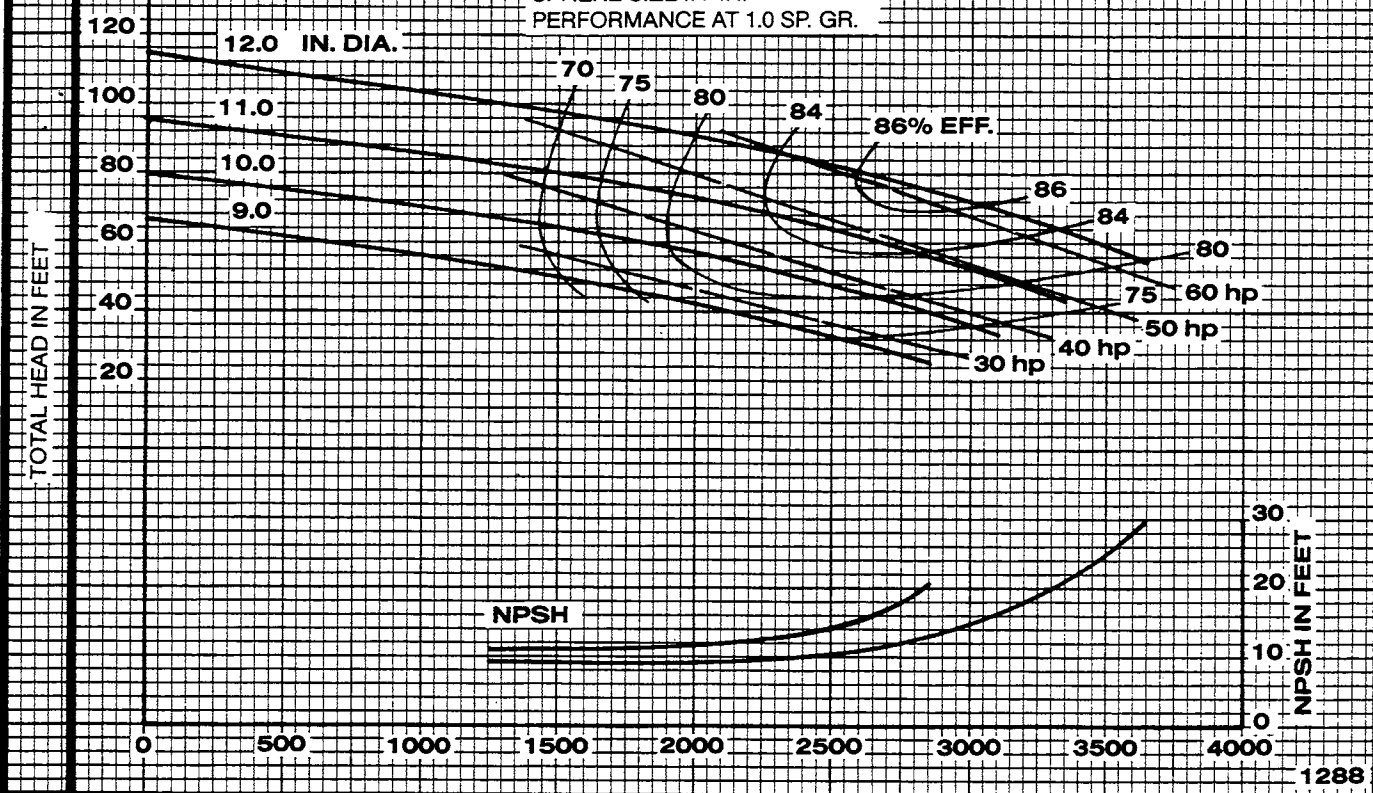

IMPELLER 2694126

U.S. GALLONS PER MINUTE

CURVE 3132112



Peerless Pump Company
Indianapolis, IN 46207-7026

HORIZONTAL SPLIT CASE PUMPS
Type 10AE14A Size 10 x 12 x 14

SECTION 1240

VELOCITY HEAD INCLUDED
TOTAL EYE AREA 90.0 SQ.IN.
SPHERE SIZE .94 IN.
PERFORMANCE AT 1.0 SP.GR.

1465 RPM

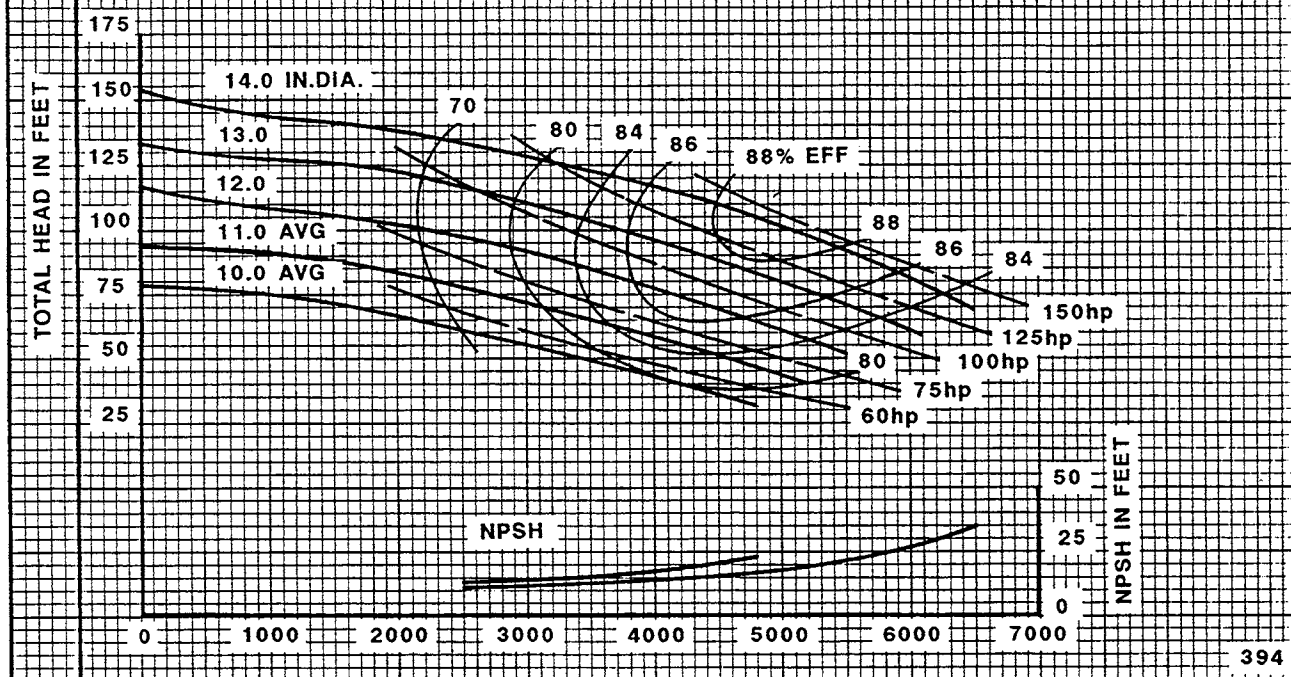

IMPELLER 2693193

U.S. GALLONS PER MINUTE

CURVE 3132136

394



Peerless Pump Company
Indianapolis, IN 46207-7026

HORIZONTAL SPLIT CASE PUMPS

Type 10AE14J

Size 10 x 12 x 14

SECTION 1240

VELOCITY HEAD INCLUDED
TOTAL EYE AREA 80.0 SQ.IN.
SPHERE SIZE .94 IN.
PERFORMANCE AT 1.0 SP.GR.

1465 RPM

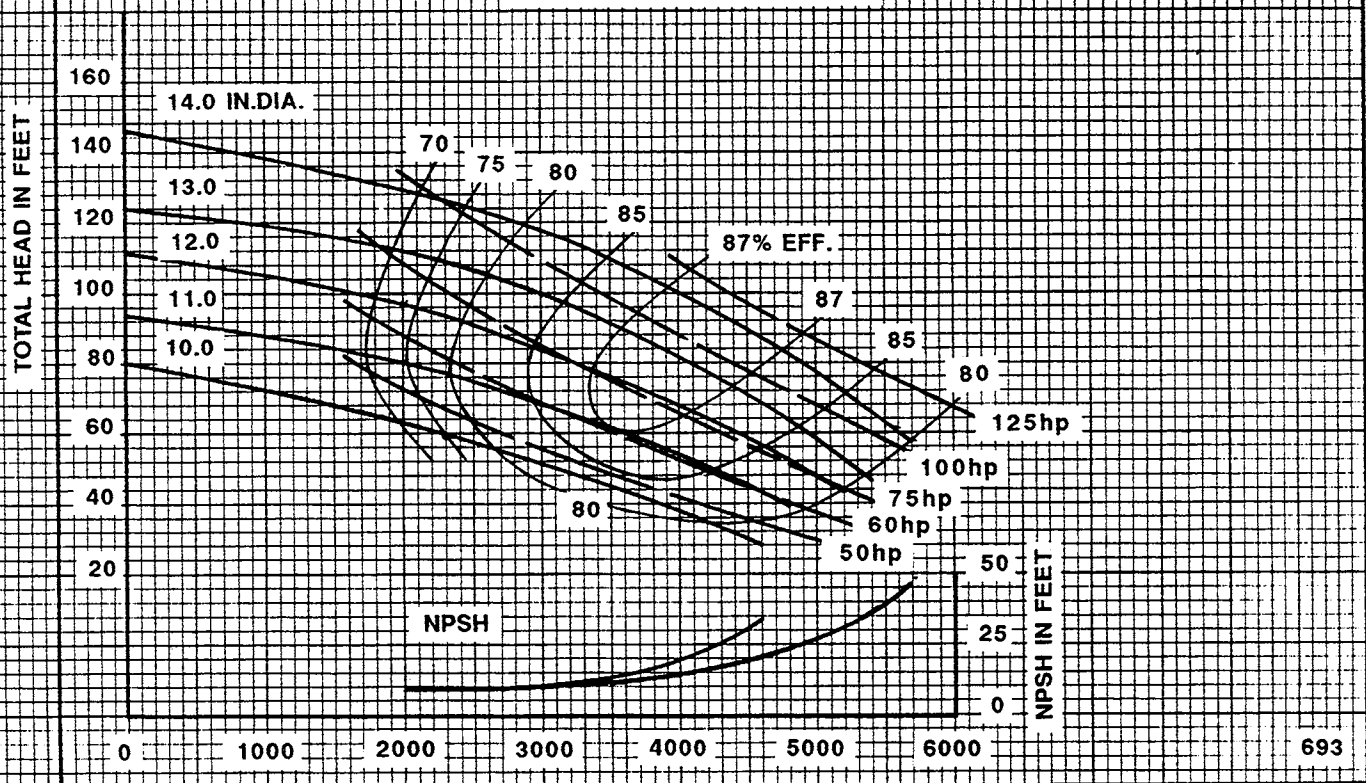

693

IMPELLER 2693192

U.S. GALLONS PER MINUTE

CURVE 3132132



Peerless Pump Company
Indianapolis, IN 46207-7026

HORIZONTAL SPLIT CASE PUMPS
Type 10AE16 Size 10 x 12 x 16

SECTION 1240

1465 RPM

VELOCITY HEAD INCLUDED
TOTAL EYE AREA 100.0 SQ.IN.
SPHERE SIZE 1.12 IN.
PERFORMANCE AT 1.0 SP.GR.

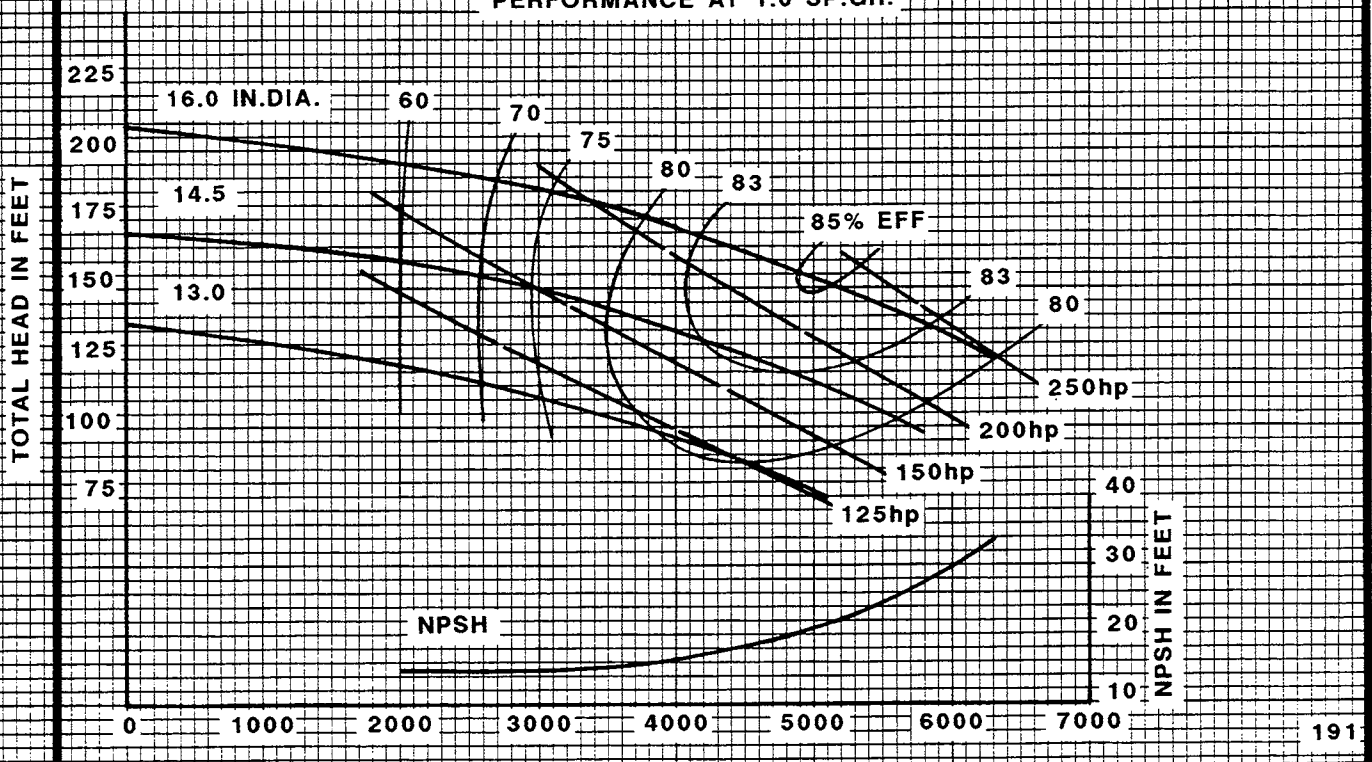

IMPELLER 2692881

U.S. GALLONS PER MINUTE

CURVE 3132124



Peerless Pump Company
Indianapolis, IN 46207-7026

HORIZONTAL SPLIT CASE PUMPS
Type 10AE20 Size 10 x 12 x 20

SECTION 1240

1470 RPM

VELOCITY HEAD INCLUDED
TOTAL EYE AREA 79.0 SQ. IN.
SPHERE SIZE .95 IN.
PERFORMANCE AT 1.0 SP. GR.

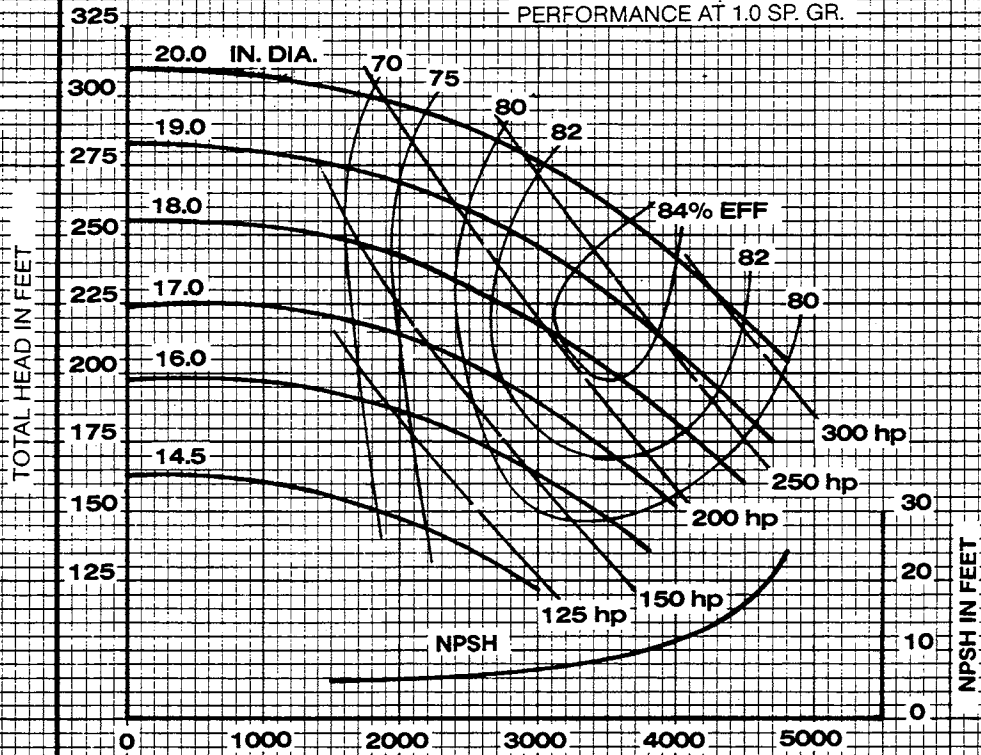

1087

IMPELLER 2693541

U.S. GALLONS PER MINUTE

CURVE 3132079